

# Operating Manual

## Alpha-30





# INDEX

## Multi-function Digital Meter Installation & Operating Instructions

Section	Contents
1.	Introduction
2.	Measurement Reading Screens
3.	Programming
3.1	Password Protection
3.2	Menu selection
3.2.1	System Parameter selection screen
3.2.1.1	System type
3.2.1.2	Potential transformer Primary value
3.2.1.3	Potential transformer secondary value
3.2.1.4	Current transformer Primary value
3.2.1.5	Current transformer Secondary value
3.2.1.6	Demand integration time
3.2.1.7	Auto Scrolling
3.2.1.8	Low current noise cutoff
3.2.1.9	Energy Display on Modbus
3.2.1.10	Energy digit reset count
3.2.2	Communication Parameter selection screen
3.2.2.1	Address Setting
3.2.2.2	RS 485 Baud rate
3.2.2.3	RS 485 Parity selection

- 3.2.3 Reset Parameter selection screen
  - 3.2.3.1 Resetting Parameter
- 3.2.4 Output Option selection screen (menu)
  - 3.2.4.1 Configuration of Output
    - 3.2.4.1.1 Relay 1 output selection menu
      - 3.2.4.1.1.1 Pulse output
        - 3.2.4.1.1.1.1 Assignment of Energy to Pulse (Relay 1)
        - 3.2.4.1.1.1.2 Pulse Duration Selection
        - 3.2.4.1.1.1.3 Pulse Rate
      - 3.2.4.1.1.2 Limit output
        - 3.2.4.1.1.2.1 Assignment of Limit Output1 to Parameter
        - 3.2.4.1.1.2.2 Limit Configuration
        - 3.2.4.1.1.2.3 Trip point selection
        - 3.2.4.1.1.2.4 Hysteresis selection
        - 3.2.4.1.1.2.5 Energizing delay time
        - 3.2.4.1.1.2.6 De-energizing delay time
    - 3.2.4.1.2 Relay 2 output selection menu
    - 3.2.4.1.3 Analog Output Selection
      - 3.2.4.1.3.1 Parameter setting for Analog Output-1
      - 3.2.4.1.3.2 Parameter setting for Analog Output-2
- 4. Phase Rotation Error screen.
- 5. On - Hour.
- 6. Number of Interruption
- 7. Analog Output
- 8. Relay Output
  - 8.1 Pulse output
  - 8.2 Limit switch

- 9. RS 485 (Modbus) output
  - 9.1 User Assignable modbus Registers
- 10. Phaser Diagram
- 11. Installation
  - 11.1 EMC Installation Requirements
  - 11.2 Case Dimensions and Panel Cut-out
  - 11.3 Wiring
  - 11.4 Auxiliary Supply
  - 11.5 Fusing
  - 11.6 Earth / Ground Connections
- 12. Connection Diagrams
- 13. Specification
- 14. Connection for Optional Pulse output / RS 485 / Analog / Ethernet Output

## 1. Introduction

The AP30 is a panel mounted 96x96mm DIN Quadratic Digital Metering system for the measurement important electrical parameters like AC voltage, AC Current, Frequency, Power, Energy (Active / Reactive / Apparent). The instrument integrates accurate measurement technology (All Voltages & Current measurements are True RMS upto 15th Harmonic) with 3 line 4 digits Ultra high brightness LED display.

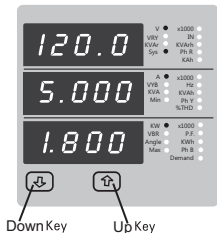

AP30 can be configured and programmed at site for the following:

- PT Primary, PT Secondary, CT Primary, CT Secondary (5A or 1A) and 3 phase 3W or 3 Phase 4W system.

The screen shown on left is of 3 Phase Meter.

The screen shown further is of 1 Phase Meter. The front panel has two push buttons through which the user may scroll through the available measurement readings, reset the energy (Import/Export) Min/Max (System Voltage and System Current) and configure the product.

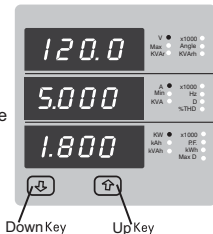

**TABLE 1:**

<b>Measured Parameters</b>	<b>Units of Measurement</b>
System Voltage	Volts
System Current	Amps
Voltage VL1-N(4wire only)	Volts
Voltage VL2-N(4wire only)	Volts
Voltage VL3-N(4wire only)	Volts
Voltage VL1-L2 ( for 3 / 4 wire)	Volts
Voltage VL2-L3 ( for 3 / 4 wire)	Volts
Voltage VL3-L1 ( for 3 / 4 wire)	Volts
Current L1( for 3 / 4 wire)	Amps
Current L2( for 3 / 4 wire)	Amps
Current L3( for 3 / 4 wire)	Amps
Neutral Current ( 4 wire only )	Amps
Frequency	Hz
Active Power (System / Phase (4 wire only) )	Kwatts
Reactive Power (System / Phase (4 wire only))	KVAh
Apparent Power (System / Phase (4 wire only))	KVA
Power Factor (System / Phase (4 wire only))	—
Phase Angle ( Phase(4 wire only))	Degree
Active Import Energy (8 Digit resolution)	kWh
Active Export Energy (8 Digit resolution)	kWh
Reactive Import Energy (8 Digit resolution)	kVAh
Reactive Export Energy (8 Digit resolution)	kVAh
Apparent Energy (8 Digit resolution)	kVAh
Ampere Hour (8 Digit resolution)	KAh

<b>Measured Parameters</b>	<b>Units of Measurement</b>
Current Demand	Amps
KVA Demand	KVA
KW Import Demand	KW
KW Export Demand	KW
Max Current Demand	Amps
Max kVA Demand	KVA
Max KW Import Demand	KW
Max KW Export Demand	KW
Run Hour	Hours
On Hour	Hours
Number of Interruptions	Counts
Phase Reversal Indication ( 4 wire only )	—
V1 THD* ( for 3 / 4 wire)	%
V2 THD* ( for 3 / 4 wire)	%
V3 THD* ( for 3 / 4 wire)	%
I1 THD ( for 3 / 4 wire)	%
I2 THD ( for 3 / 4 wire)	%
I3 THD ( for 3 / 4 wire)	%
System Voltage THD	%
System Current THD	%

**\*Note : THD Parameters are L-N in case of 3P 4W & L-L in case of 3P 3W .**



## 2. Measurement Reading Screens

In normal operation the user is presented with one of the measurement reading screens out of several screens. These screens may be scrolled through one at a time in incremental order by pressing the “↑ Up key” and in decremental order by pressing the “↓ Down key”.

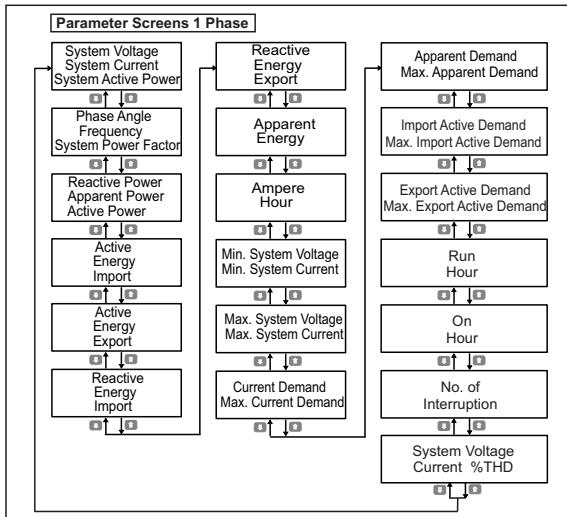

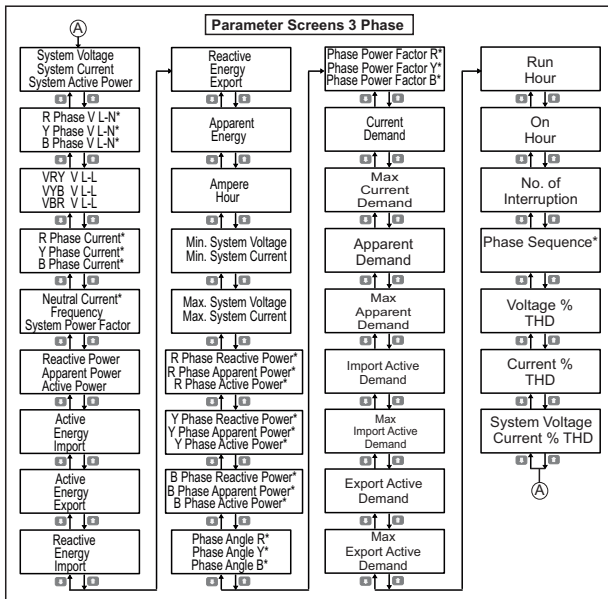

NOTE: SCREENS MARKED WITH \* ARE AVAILABLE ONLY IN 4W SYSTEM (NOT IN 3 WIRE SYSTEM)

## Setup Parameter Screens

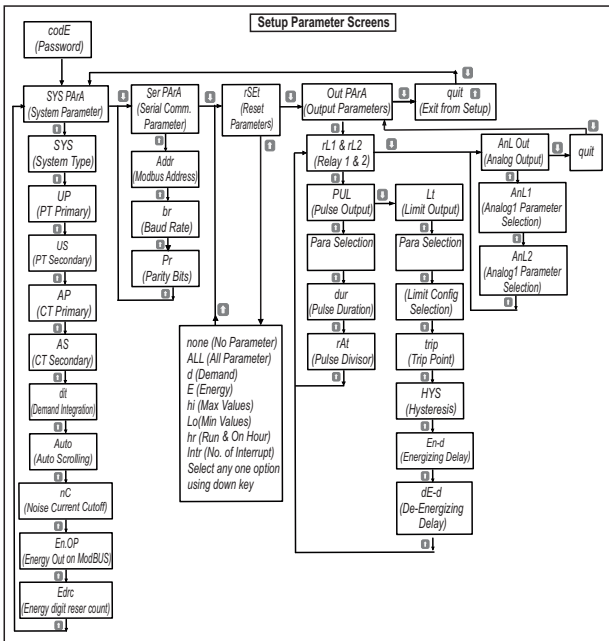

### 3. Programming

The following sections comprise step by step procedures for configuring the AP30 for individual user requirements.

To access the set-up screens press and hold the “**↓** Down” and “**↑** Up” Key simultaneously for 5 seconds. This will take the User into the Password Protection Entry Stage (Section 3.1).

#### 3.1. Password Protection

Password protection can be enabled to prevent unauthorized access to set-up screens, by default password protection is not enabled.

Password protection is enabled by selecting a four digit number other than 0000, setting a password of 0000 disables the password protection.

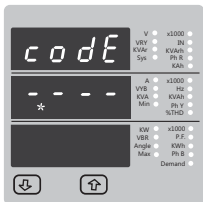

Enter Password, prompt for first digit.  
(\* Denotes that decimal point will be flashing).

Press the “**↓** Down” key to scroll the value of the first digit from 0 through to 9, the value will wrap from 9 round to 0.

Press the “**↑** Up” key to advance to next digit.

In the special case where the Password is “0000” pressing the “**↑** Up” key when prompted for the first digit will advance to the “Password Confirmed” screen.

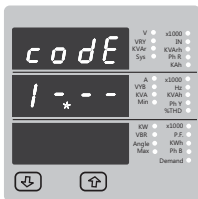

Enter Password, first digit entered, prompt for second digit.

(\* Denotes that decimal point will be flashing).

Use the “**↓** Down” key to scroll the value of the second digit from 0 through to 9, the value will wrap from 9 round to 0.

Press the “**↑** Up” key to advance to next digit.

Enter Password, second digit entered, prompt for third digit.

(\* Denotes that decimal point will be flashing).

Use the “**↓** Down” key to scroll the value of the third digit from 0 through to 9, the value will wrap from 9 round to 0.

Press the “**↑** Up” key to advance to next digit.

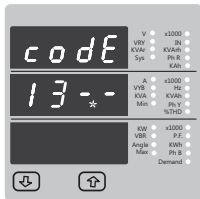

Enter Password, third digit entered, prompt for fourth digit.

(\* Denotes that decimal point will be flashing).

Use the “**↓** Down” key to scroll the value of the fourth digit from 0 through to 9, the value will wrap from 9 round to 0.

Press the “**↑** Up” key to advance to verification of the password.

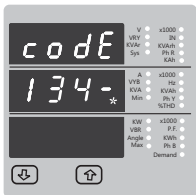

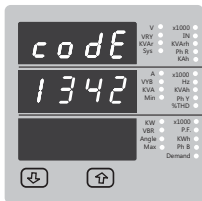

Enter Password, fourth digit entered, awaiting verification of the password.

### Password confirmed.

Pressing “↓ Down” key will advance to the “New / change Password” entry stage.

Pressing the “↑ Up” key will advance to the Menu selection

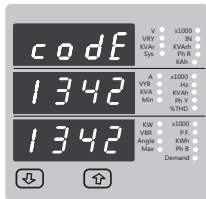

### Password Incorrect.

The unit has not accepted the Password entered.

Pressing the “↓ Down” key will return to the Enter Password stage.

Pressing the “↑ Up” key exits the Password menu and returns operation to the measurement reading mode.

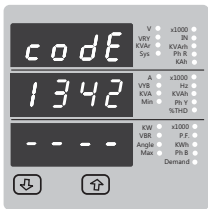

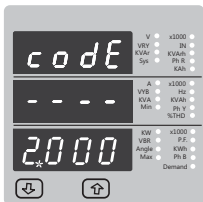

## New / Change Password

(\*Decimal point indicates that this will be flashing).

Pressing the "↓ Down" key will scroll the value of the first digit from 0 through to 9, the value will wrap from 9 round to 0.

Pressing the "↑ Up" key to advance the operation to the next digit and sets the first digit, in this case to "2"

New / Change Password, first digit entered, prompting for second digit. (\*Decimal point indicates that this will be flashing).

Pressing the "↓ Down" key will scroll the value of the second digit from 0 through to 9, the value will wrap from 9 round to 0.

Pressing the "↑ Up" key to advance the operation to the next digit and sets the second digit, in this case to "1"

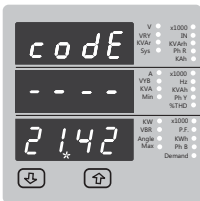

New / Change Password, second digit entered, prompting for third digit. (\*decimal point indicates that this will be flashing).

Pressing the "↓ Down" key will scroll the value of the third digit from 0 through to 9, the value will wrap from 9 round to 0.

Pressing the "↑ Up" key to advance the operation to the next digit and sets the third digit, in this case to "5"

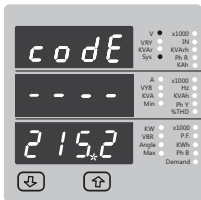

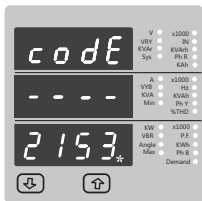

### New Password confirmed.

Pressing the “**↓** Down” key will return to the “New/Change Password”.

Pressing the “**↑** Up” key will advance to the Menu selection screen.(see section 3.2).

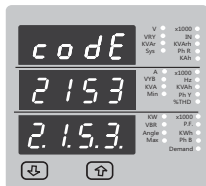

New / Change Password, third digit entered, prompting for fourth digit. (\* denotes that decimal point will be flashing).

Pressing the “**↓** Down” key will scroll the value of the fourth digit from 0 through to 9, the value will wrap from 9 round to 0.

Pressing the “**↑** Up” key to advance the operation to the “New Password Confirmed” and sets the fourth digit, in this case to “3”.

## 3.2 Menu selection.

### 3.2.1 System Parameter selection screen.

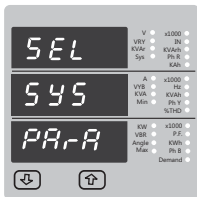

This screen is used to select the different system Parameter like “system type,” “CT Ratio,” “PT Ratio”,

Pressing the “**↑** Up” key allows the user to set Different system parameters. (see section 3.2.1.1 to 3.2.1.10)

Pressing the “**↓** down” key will advance to Communication selection screen (see section 3.2.2)



## 3.2.2 Communication Parameter selection screen.

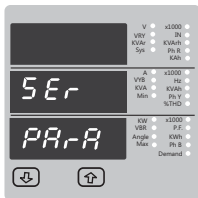

This screen is used to select the different communication parameters like "Address selection", "RS485 Parity selection", "Rs485 baud rate"

Pressing the "↑ Up" key allows the user to set different Communication parameters (see section 3.2.2.1 to 3.2.2.3)

Pressing the "↓ down key will advance to Reset parameter Screen. (see section 3.2.3)

## 3.2.3 Reset Parameter selection screen.

This screen is used to Reset the different parameters .

Pressing the "↑ Up" key allows the user to Reset different system parameters (see section 3.2.3.1)

Pressing the "↓ down key " will advance to Output Option selection screen (see section 3.2.4).

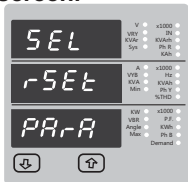

## 3.2.4 Output Option selection screen.

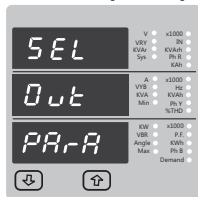

This screen will allow the user to select different Output options Like "Relay1", "Relay2", "Analog" Output.

Pressing the "↑ Up" key allows the user to select & Configure the output option (see section 3.2.4.1)

Pressing the "↓ down key will advance to Quit screen. (see section 3.2.5)

## 3.2.5 Quit screen.

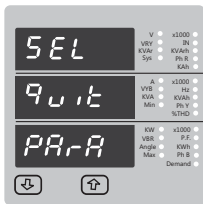

This screen will allow the user to Quit the Menu

Pressing the "↑Up" key will allow the user to Quit from menu & return to measurement screen.

Pressing the "↓down key will advance to system Parameter Selection screen (see section 3.2.1)

## 3.2.1 System parameters Selection

### 3.2.1.1 System Type

This screen is used to set the system type .  
System type "3" for 3 phase 3 wire & "4" for 3 phase 4 wire system.

Pressing the "↑ Up" key accepts the present value and advances to the "Potential transformer primary value Edit" menu (see section 3.2.1.2)

Pressing the "↓Down" key will enter the system type edit mode and scroll the values through values available .

Pressing the "↑Up" key advances to the system type confirmation menu.

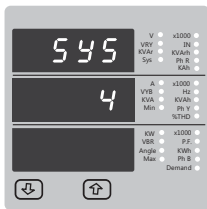

## System Type Confirmation

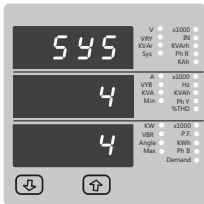

This screen will only appear following the edit of system type. If system type is to be Downed again,

Pressing the “**↑** Up” key sets the displayed value and will advance to “Potential Transformer Primary Value Edit” menu. (See section 3.2.1.2)

Pressing the “**↓** Down” key will return to the system type edit stage by blanking the bottom line of the display

### 3.2.1.2 Potential Transformer Primary Value

The nominal full scale voltage which will be displayed as the Line to Line voltages for all system types. The values displayed represent the voltage in kilovolts (note the x1000 enunciator).

Pressing the “**↑** Up” key accepts the present value and advances to the “Potential Transformer secondary Value edit” menu. (See Section 3.2.1.3)

Pressing the “**↓** Down” key will enter the “Potential Transformer Primary Value Edit” mode.

Initially the “multiplier must be selected, pressing the “Down” key will move the decimal point position to the right until it reaches ###.# after which it will return to #.###.

Pressing the “**↑** Up” key accepts the present multiplier (decimal point position) and advances to the “Potential Transformer Primary Digit Edit” mode.

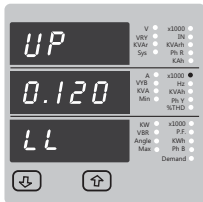

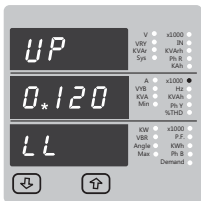

## Potential Transformer Primary Digit Edit

Pressing the “**↓**Down” key will scroll the value of the most significant digit from 0 through to 9 unless the presently displayed Potential Transformer Primary Value together with the Current Transformer Primary Value, previously set, would result in a maximum power of greater than 666.6 MVA per phase in which case the digit range will be restricted.

Pressing the “**↑**Up” key accepts the present value at the cursor position and advances the cursor to the next less significant digit.

The PT Primary value can be set from 100V L-L to 692.8 kV L-L.

Note : the flashing decimal point indicates the cursor position, a steady decimal point will be present to identify the scaling of the number until the cursor position coincides with the steady decimal point position. At this stage the decimal point will flash.

When the least significant digit has been set pressing the “**↑**Up” key will advance to the “Potential Transformer Primary Value Confirmation” stage.

Screen showing display of 0.120 kV i.e. 120 Volts indicating steady decimal point and cursor flashing at the “hundreds of volts” position.

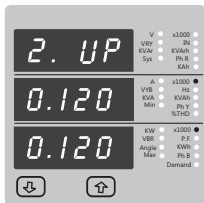

Note : 0.120 kV i.e. 120 V<sub>L-L</sub>

### Potential Transformer Primary Value Confirmation

This screen will only appear following an edit of the Potential Transformer Primary Value.

If the scaling is not correct, pressing the “**↓ Down**” key will return to the “Potential Transformer Primary Value Edit” stage.

Pressing the “**↑ Up**” key sets the displayed value and will advance to the Potential Transformer Secondary Value (See Section 3.2.1.3)

### 3.2.1.3 Potential Transformer secondary Value

The value must be set to the nominal full scale secondary voltage which will be obtained from the Transformer when the potential transformer(PT)primary is supplied with the voltage defined in 3.2.1.2. potential transformer primary voltage. The ratio of full scale primary to full scale secondary is defined as the transformer ratio.

Pressing the “**↑ Up**” key accepts the present value and advances to the “Current Transformer Primary Value edit” menu. (See Section 3.2.1.4)

The Valid range of instrument is from 100 to 600V<sub>L-L</sub>.

Pressing the “**↓ Down**” key will enter the “Potential Transformer Secondary Value Edit” mode.

Down” key will scroll the value of the most significant digit from available range of PT secondary value

Pressing the “**↑ Up**” key accepts the present value at the cursor position and advances the cursor to the next less significant digit.

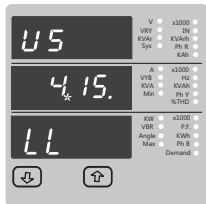

Note : the flashing decimal point indicates the cursor position, a steady decimal point will be present to identify the scaling of the number until the cursor position coincides with the steady decimal point position. At this stage the decimal point will flash.

When the least significant digit has been set pressing the “**↑Up**” key will advance to the “Potential Transformer secondary Value Confirmation” stage.

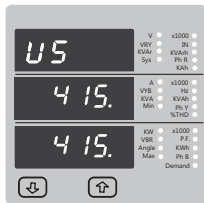

#### Potential Transformer Secondary Value Confirmation

This screen will only appear following an edit of the Potential Transformer Secondary Value.

If the scaling is not correct, pressing the “**↓Down**” key will return to the “Potential Transformer Secondary Value Edit”

Pressing the “**↑Up**” key sets the displayed value and will advance to the Current Transformer Primary Value (See Section 3.2.1.4)

### 3.2.1.4 Current Transformer Primary Value

The nominal Full Scale Current that will be displayed as the Line currents. This screen enables the user to display the Line currents inclusive of any transformer ratios, the values displayed represent the Current in Amps.

Pressing the “**↑Up**” key accepts the present value and advances to the Current Transformer Secondary Value (See Section 3.2.1.5)

Pressing the “**↓Down**” key will enter the “Current Transformer Primary Value Edit” mode. This will scroll the value of the most significant digit from 0 through to 9, unless the presently displayed Current Transformer Primary Value together with the Potential Transformer

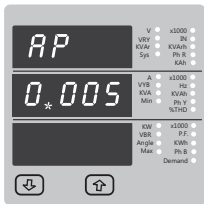

Primary Value results in a maximum power of greater than 666.6 MVA in which case the digit range will be restricted, the value will wrap. Example: If primary value of PT is set as 692.8kV L-L (max value) then primary value of Current is restricted to 1157A.

Pressing the "Up" key will advance to the next less significant digit. (\* Denotes that decimal point will be flashing).

The "Maximum Power" restriction of 666.6 MVA refers to 120% of nominal current and 120% of nominal voltage, i.e., 462.96 MVA nominal power per phase.

When the least significant digit had been set, pressing the "Up" key will advance to the "Current Transformer Primary Value Confirmation" stage.

The minimum value allowed is 1, the value will be forced to 1 if the display contains zero when the "Up" key is pressed.

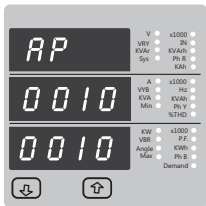

Current Transformer Primary Value Confirmation.

This screen will only appear following an edit of the Current Transformer Primary Value.

If the scaling is not correct, Pressing the "Down" key will return to the "Current Transformer Primary Value"Edit stage with the most significant digit highlighted (associated decimal point flashing) and the bottom line of the display will be blanked. Pressing the "Up" key sets the displayed value and will advance to the "Current Transformer Secondary Value Edit" menu. (See Section 3.2.1.5)

### 3.2.1.5 Current Transformer Secondary Value

This screen is used to set the secondary value for Current Transformer. Secondary value "5" for 5A or "1" for 1A can be selected. Pressing "⬆️ Up" key accepts the present value and advances to the Demand integration Time (See Section 3.2.1.6)

Pressing the "⬇️ Down" key will enter the CT Secondary value edit mode and scroll the value through the values available.

Pressing the "⬆️ Up" key will advance to the CT Secondary value confirmation.

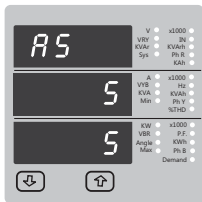
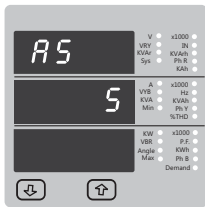

#### CT Secondary value confirmation

This screen will only appear following an edit of CT secondary value .

If secondary value shown is not correct, pressing the Down key will return to CT secondary edit stage by blanking the bottom line of the display.

Pressing "⬆️ Up" key sets the displayed value and will advance to Demand integration Time Edit menu. (See Section 3.2.1.6)

### 3.2.1.6 Demand Integration Time

This screen is used to set the period over which current and power readings are to be integrated .The Unit of displayed Readings is minutes.



Pressing the "↓ Down" key will scroll through the Following Options 8,15,20,30.

Pressing the "↑ Up" key will advance to Demand Integration confirmation screen.

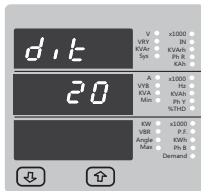
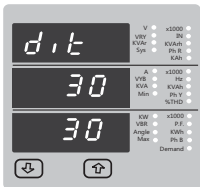

### Demand Integration Time value confirmation

Pressing "↑Up" key sets the displayed value and will advance to scroll screen.

(See Section 3.2.1.7)

### 3.2.1.7 Auto Scrolling :

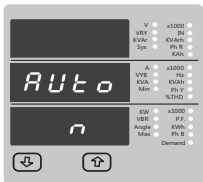

This screen allows user to enable screen scrolling. Auto scrolling Edit.

Pressing "↑ Up" key accepts the present status and advance to the Low Current noise cutoff (See Section 3.2.1.8).

Pressing the "↓ Down" key will enter the "Auto Screen Scrolling Edit" and toggle the status 'Yes' and 'No'.

Pressing the "↑ Up" key will select the status displayed and advance to the Low Current noise cutoff (See Section 3.2.1.8)

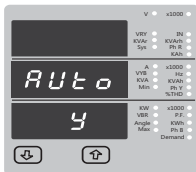

### 3.2.1.8 Low Current noise cutoff.

This screen allows the user to set Low noise current cutoff in mA.

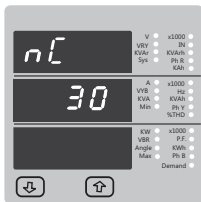

Low current noise cutoff Edit.

Pressing “**↑ Up**” key accepts the present value and advance to Energy Display on Modbus.  
(See section 3.2.1.9)

Pressing the “**↓ Down**” key will enter the “Low current noise cutoff Edit” mode and scroll the “Value” through 0 & 30 and wrapping back to 0. Setting 30 will display measured currents as 0 below 30 mA.

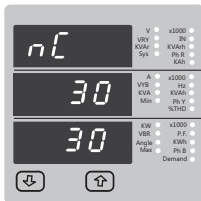

Low current noise cutoff Confirmation.

pressing the “**↓ Down**” key will re-enter the “Low current Noise cutoff Edit” mode.

Pressing “**↑ Up**” key set displayed value and Advance to the Energy Display on Modbus selection  
(See section 3.2.1.9)

### 3.2.1.9. Energy Display on modbus

This screen enable user to set energy in terms of Wh / KWh / MWh on RS 485 Output depending as per the requirement .Same applicable for all types of energy.

Pressing “**↑ Up**” key accepts the presents value and advances to the “Energy digit reset count” menu (See section 3.2.1.10).

Pressing the “↓ Down” key will enter the “Energy Display On Modbus Edit” mode and scroll the value through the values 1,2 & 3 wrapping back to 1

- 1 : Energy In Wh
- 2 : Energy in KWh
- 3 : Energy in MWh.

Pressing the “↑ Up” key advances to the “Energy Display On Modbus Confirmation” menu.

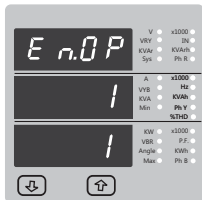
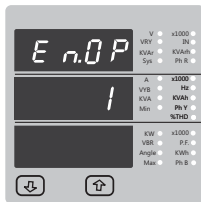

Energy Display On Modbus Confirmation.

This screen will only appear following an edit of the Energy Display On Modbus.

Pressing the “↓ Down” key will enter the “Energy Display On Modbus Edit” Edit” stage by blanking the bottom line of the display.

Pressing “↑ Up” key sets the displayed value and will advance to the “Energy digit reset count” menu. (See section 3.2.1.10)

**Note : Default value is set to ‘1’ i.e. Energy on Modbus will be in terms of Wh/VArh/VAh/Ah resp.**

### 3.2.1.10 Energy Digit reset count :

This screen enables user for setting maximum energy count after which energy will rollback to zero depends upon setting of Wh,KWh & MWh.

Pressing the "⬆️ Up" key sets the displayed value and will jump back to the system parameter selection (See Section 3.2.1)

Pressing the "⬇️ Down" key will enter the Energy digit reset count edit mode. This will scroll the value of reset count **from 7 to 14 for Wh, from 7 to 12 for KWh & from 7 to 9 for MWh.**

Ex. If energy display on modbus is set Wh & It will set Energy digit count to 10 then energy will reset after "9,999,999,999" & then will rollback to zero.

Pressing "⬆️ Up key " will advance to Energy digit reset count confirmation screen.

Pressing the "⬇️ Down" key will re-enter Energy digit reset count edit mode.

Pressing the "⬆️ Up" key sets the displayed value and will jump back to the system parameter selection (See Section 3.2.1)

**Note : 1) Default value is set to "14" i.e if energy count crosses 14 digit it will rollback to zero.**

**2) Energy displays on modbus is set to (2) & energy digit reset count is set to 12.**

**Energy screen on display will show "-----" i.e Energy overflow. When energy crosses the 11 digit count.**

**3) Energy displays on modbus is set to (3) & energy digit reset count is set to 9.**

**Energy screen on display will show "-----" i.e Energy overflow .when energy crosses the 8 digit count.**

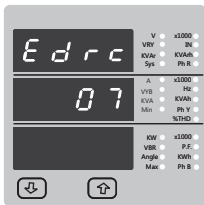

## 3.2.2 Communication Parameter Selection :

**3.2.2.1 Address Setting :** This screen applies to the RS 485 output only. This screen allows the user to set Rs485 parameter for instruments

The range of allowable address is 1 to 247 .

Enter Address, prompt for first digit.

(\* Denotes that decimal point will be flashing).

Press the "⬇️Down" key to scroll the value of the first digit

Press the "⬆️Up" key to advance to next digit.

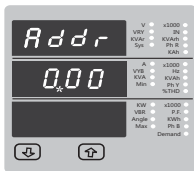
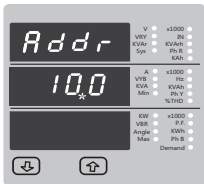

Enter Address, first digit entered, prompt for second digit  
(\* Denotes that decimal point will be flashing).

Use the "⬇️Down" key to scroll the value of the second digit.

Press the "⬆️Up" key to advance to next digit.

Enter Address, second digit entered, prompt for third digit (\* Denotes that decimal point will be flashing).

Use the "⬇️Down" key to scroll the value of the third digit

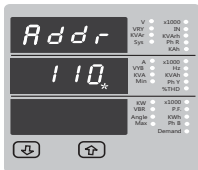
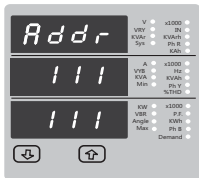

Address confirmation Screen.

This Screen confirms the Address set by user .

Press the "⬆️Up" key to advance to next Screen  
"Rs485 Baud Rate" (See Section 3.2.2.2)

Pressing the "⬇️Down" key will reenter the "Address Edit" mode.

### 3.2.2.2 RS 485 Baud Rate :

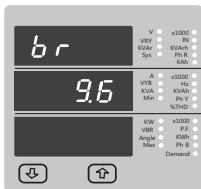

This screen allows the user to set Baud Rate of RS 485 port. The values displayed on screen are in kbaud ..

Pressing the “**↑** Up” key accepts the present value and advance to the Parity Selection (See Section 3.2.2.3)

Pressing the “**↓** Down” key will enter the “Baud Rate Edit” mode and scroll the value through 2.4, 4.8, 9.6 , 19.2 and back to 2.4

RS 485 Baud Rate confirmation :

Pressing “**↓** Down” key will be re-enter into the Baud Rate Edit mode

Pressing the “**↑** Up” key will select the value and advances to the Parity Selection (See Section 3.2.2.3).

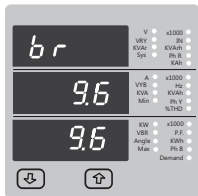

### 3.2.2.3 RS 485 Parity Selection :

This screen allows the user to set Parity & number of stop bits of RS 485 port.

Pressing “**↑** Up” key accepts the present value and advance to Menu selection (see section 3.2).

Pressing the “**↓** Down” key will enter the “Parity & stop bit Edit” mode and scroll the value through

**odd** : odd parity with one stop bit

**no 1** : no parity with one stop bit

**no 2** : no parity with two stop bit

**E** : even parity with one stop bit

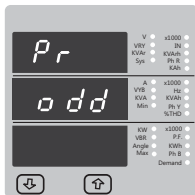

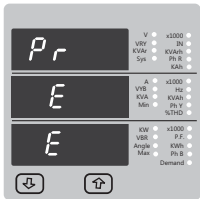

RS 485 Parity confirmation :

Pressing “**↓Down**” key will be re-enter into Parity Edit mode.

Pressing the “**↑Up**” key will set the value.

Pressing the “**↑Up**” key again will jump back to the communication parameter selection menu (see section 3.2.2).

### 3.2.3 Reset Parameter Selection :

#### 3.2.3.1 Resetting Parameter

The following screens allow the users to reset the all Energy , Lo(Min), hi(Max), Demand, Run hour, On hour, No.of Interrupts

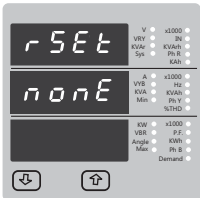

Reset (None)

Pressing “**↑Up**” key advances to Reset Parameter selection screen (see section 3.2.3)

Pressing the “**↓Down**” key will enter the “Reset option” mode and scroll through Parameter and wrapping back to None.

Reset option select, (Resets ALL resettable parameter)

The user has scrolled through to the “ALL” .

Pressing “**↑Up**” key will select the value and advance to the “Reset ALL Confirmation” Mode & Will reset all resettable parameter.

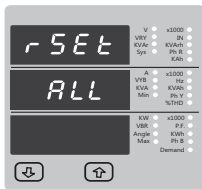

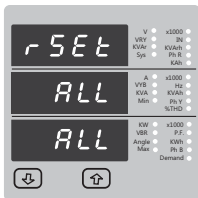

Reset ALL Confirmation.

Pressing the “↓Down” key will re-enter the Reset option Select mode.

Pressing “↑Up” key will jump back to the Reset Parameter selection screen (see section 3.2.3).

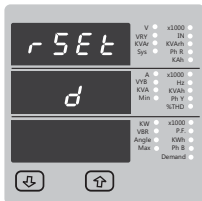

Reset option select, (Reset A Demand, KVA Demand Parameters KW demand (Import/Export))

The user has scrolled through to the “d” .

Pressing “↑Up” key will select the value and advance to the “Reset “d” Confirmation” Mode & resets all Demand parameters.

Reset Demand parameters Confirmation.

Pressing the “↓Down” key will re-enter the “Reset option Select mode.

Pressing “↑Up” key will jump back to the Reset Parameter selection screen (see section 3.2.3).

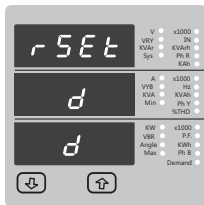



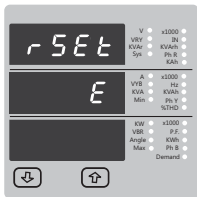

Reset option select, (Resets all Energies)

The user has scrolled through to the "E" Energy value.

Pressing "**↑Up**" key will select the value and advance to the "Reset Energy Confirmation" Mode. & resets all Energies (Import Energy, Export Energy Import reactive, Export reactive, Apparent Energy Ampere Hour)

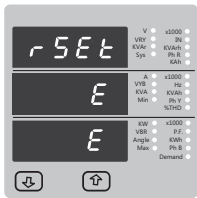

Reset Energy Confirmation.

Pressing the "**↓Down**" key will re-enter the "Reset option" mode.

Pressing "**↑Up**" key will jump back to the Reset Parameter selection screen (see section 3.2.3).

Reset option select, (Reset Hi)

The user has scrolled through to the "Hi" (Max)

Pressing "**↑Up**" key will select the value and advance to the "Reset Hi Confirmation" Mode. Will reset Maximum (Hi) values of Voltage & Current Avg. appeared at input.

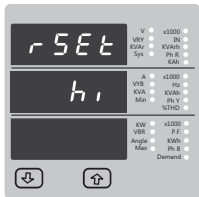

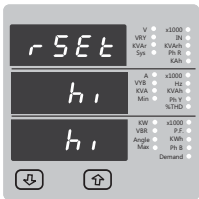

Reset option select, (Reset Lo)

The user has scrolled through to the “Lo” (Min)

Pressing “**↑**Up” key will select the value and advance to the “Reset Lo Confirmation” Mode & Will reset minimum values of Voltage & Current Avg .appeared at Input.

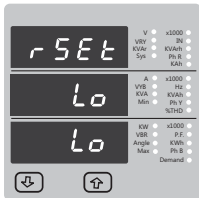

Reset option select, hr (ON Hour & Run Hour) The user has scrolled through to the “hr” Pressing “**↑**Up” key will select the value and advance to the “Reset hr Confirmation” Mode & Will reset On hour & Run Hour both.

Reset hl (Max) Confirmation.

Pressing the “**↓**Down” key will re-enter the “Reset option Select mode.

Pressing “**↑**Up” key will jump back to the Reset Parameter selection screen (see section 3.2.3).

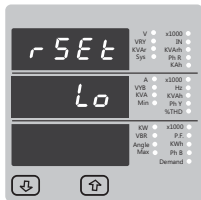

Reset Lo Confirmation

Pressing the “**↓**Down” key will re-enter the “Reset option Select mode.

Pressing “**↑**Up” key will jump back to the Reset Parameter selection screen (see section 3.2.3).

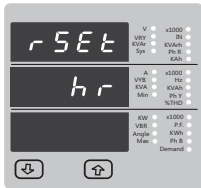

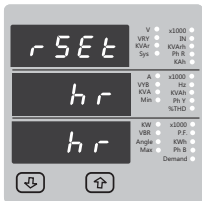

## Reset hr Confirmation

Pressing the “**↓**Down” key will re-enter the “Reset option Select mode.”

Pressing “**↑**Up” key will jump back to the Reset Parameter selection screen (see section 3.2.3).

Reset option select, (Reset Number of Interrupt)

The user has scrolled through to the “intr”

Pressing “**↑**Up” key will select the value and advance to the “reset Interrupt Confirmation” Mode & Will reset number of Auxiliary supply interruption count.

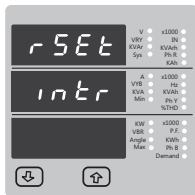

## Reset Interrupt Confirmation

Pressing the “**↓**Down” key will re-enter the “Reset parameter Selection”(see section 3.2.3).

Pressing “**↑**Up” key will jump back to the Reset Parameter selection screen (see section 3.2.3).

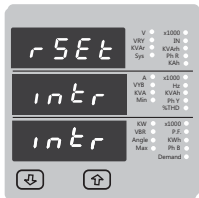

## 3.2.4. Output Option selection menu

### 3.2.4.1 Configuration of Output

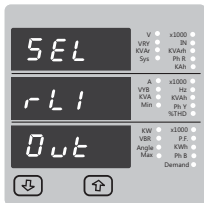

This screen applies to the Relay1 Output option Selection .

Pressing “**↑**Up” key will select the

Relay1 output selection menu(See section 3.2.4.1.1)

pressing the “**↓**Down” key will advance

Relay2 output option below.

This screen applies to the Relay2 Output option Selection .

Pressing “**↑**Up” key will advance to the select Relay 2 output selection menu.(See section 3.2.4.1.2)

pressing the “**↓**Down” key will advance to Analog output option below.

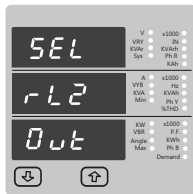

This screen applies to the Analog Output Selection.

Pressing “**↑**Up” key will Select the Analog output selection menu (See section 3.2.4.3)

Pressing the “**↓**Down” key will advance to Quit screen.

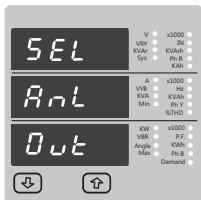

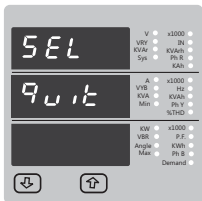

This screen allows the user to quit the output option

Pressing “**↑**Up” key will advance to the Output Parameter selection (See section 3.2.4)

Pressing the “**↓**Down” key will go back to Relay1 output option (See section 3.2.4.1).

### 3.2.4.1.1 Relay1 output Selection menu :

#### 3.2.4.1.1.1 Pulse output :

This screen is used to assign Relay1 in Pulse output mode.

Pressing “**↑**Up” key will advance to the Pulse (for Relay1) output configuration (See section 3.2.4.1.1.1.1)

Pressing “**↓**Down” key will show “Limit”output option (See section 3.2.4.1.1.2)

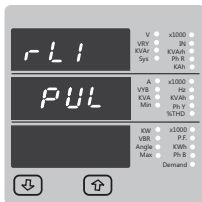

#### 3.2.4.1.1.2 Limit output :

This screen is used to assign Relay1 in limit output mode.

Pressing “**↑**Up” key will assign Limit (for Relay1) output mode(See section 3.2.4.1.1.2.1)

Pressing “**↓**Down” key will go back to the pulse option (For Relay 1) screen.(See section 3.2.4.1.1.1)

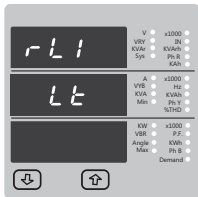

### 3.2.4.1.1.1.1 Assignment of Energy to pulse output (Relay 1) :

This screen allows the user to assign pulse output to energy (for Relay 1)

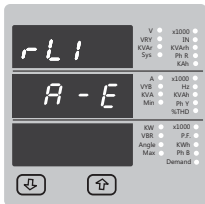

Pressing "↑Up" key accepts the present setting and advance to "Pulse duration selection" (see section 3.2.4.1.1.1.2).

Pressing the "↓Down" key will enter into edit mode and scroll through the energy setting

**A - E** : Apparent Energy      **I - rE** : Import Reactive Energy  
**I - E** : Import Active Energy    **E - rE** : Export Reactive Energy  
**E - E** : Export Active Energy    **A - H** : Ampere Hour

Pulse output (for Relay 1) confirmation :

Pressing "↓Down" key will be re-enter into edit mode .

Pressing the "↑Up" key will set the value and advances to the " Pulse duration selection "(see section 3.2.4.1.1.1.2).

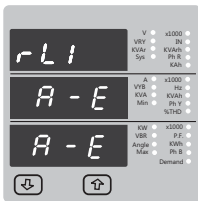

### 3.2.4.1.1.1.2 Pulse Duration Selection:

This screen applies only to the Pulsed output mode of both the relay

This screen allows the user to set Relay energisation time in milliseconds.

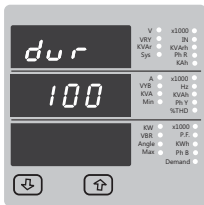

Pulse Duration Edit.

Pressing “**↑Up**” key accepts the present value and advance to pulse rate selection menu (see section 3.2.4.1.1.1.3).

Pressing the “**↓Down**” key will enter the “Pulse Duration Edit” mode and scroll the value through 60, 100, 200 and wrapping back to 60.

Pressing the “**↑Up**” key will select the value and advances to “Pulse Duration Confirmation”.

Pulse Duration Confirmation.

This screen will only appear following an edit of the Pulse duration.

Pressing the “**↓Down**” key will re-enter the “Pulse Duration Edit” mode.

Pressing “**↑Up**” key set displayed value and Will advance to pulse rate selection menu (See section 3.2.4.1.1.1.3)

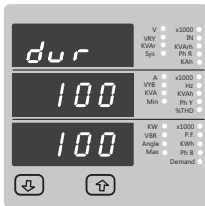

### 3.2.4.1.1.1.3 Pulse Rate

This screen applies to the Relay Output option only. The screen allows user to set the energy pulse rate divisor. Divisor values can be selected through 1,10,100,1000 in Wh.

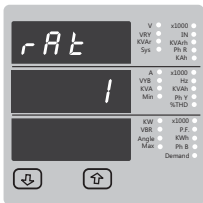

Pressing “**↑Up**” key accepts the presents value and advances to the “Configuration of Output” (See section 3.2.4.1).

Pressing the “**↓Down**” key will enter the “Pulse rate divisor Edit” mode and scroll the value through the values 1,10,100,1000 wrapping back to 1 in Wh but in KWh & MWh pulse rate divisor is only 1.

Pressing the “**↑Up**” key advances to the “Pulse rate Divisor Confirmation” menu.

For setting divisor value refer table 3.

#### Pulse Rate Divisor Confirmation.

This screen will only appear following an edit of the Pulse rate divisor.

If the Pulse rate shown is not correct, pressing the “**↓Down**” key will return to the “Pulse rate divisor Edit” stage by blanking the bottom line of the display.

Pressing “**↑Up**” key sets the displayed value and will advance to the “Configuration of output”. (See section 3.2.4.1)

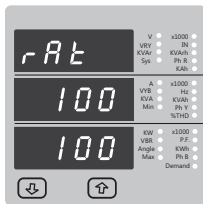

#### 3.2.4.1.1.2.1 Assignment of Parameter to Limit output (for Relay1)

This screen is for Limit output mode selection. It allows the user to set Limit output corresponding measured value . Refer Table 2" Parameter for Analog & Limit output " for assignment.



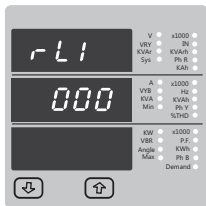

Pressing the “**↑Up**” key accepts the present value and advance to the Limit1 configuration select screen. (see section 3.2.4.1.1.2.2 ).

Pressing the “**↓Down**” key will enter the “ Limit1 output Edit” mode and scroll the values, as per Table 2, “ Parameter for Analog & Limit Output”

Pressing the “**↑Up**” key advance to the Limit1 output confirmation screen .

Limit1 output Confirmation :

Pressing the “**↓Down**” key will re-enter the “ Limit1 output Edit” mode.

Pressing the “**↑Up**” key sets the displayed value and will advance to the Limit1 Configuration select screen ( see section 3.2.4.1.1.2.2 )

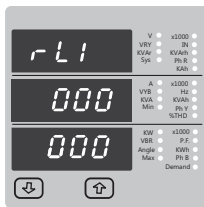

### 3.2.4.1.1.2.2 Limit1 Configuration select

This screen is used to set the Limit1 Configuration, four different types of configuration can be selected

- H i - E (High Alarm & Energized Relay)
- H i - d (High Alarm & De-Energized Relay)
- L o - E (Low Alarm & Energized Relay)
- L o - d (Low Alarm & De-Energized Relay)

**(For detail refer to section 9.2)**

Pressing the “**↑Up**” key accepts the present value and advances to the “Trip point selection” screen (see section 3.2.4.1.1.2.3)

Pressing the “**↓** Down” key will enter the Limit1 configuration edit mode and scroll through the Modes available .

Pressing the “**↑** Up” key advances to the Limit1 configuration type confirmation menu.

### Limit1 Configuration Confirmation

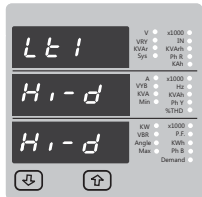
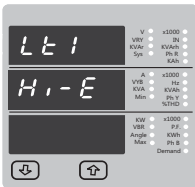

This screen will only appear following the edit of system type. If system type is to be changed again, pressing the “**↓** Down” key will return to the Limit1 configuration Type edit stage by blanking the bottom line of the display.

Pressing the “**↑** Up” key sets the displayed value and will advance to “Trip point selection” Screen (See section 3.2.4.1.1.2.3 )

### 3.2.4.1.1.2.3 Trip point selection :

This screen applies to the Trip point selection for instrument.

The allowable range is 10% to 120% for High Alarm and 10% to 100% for Low Alarm .

Enter value, prompt for first digit.  
(\* Denotes that decimal point will be flashing).

Press the “**↓** Down” key to scroll the values of the first digit

Press the “**↑** Up” key to advance to next digit.

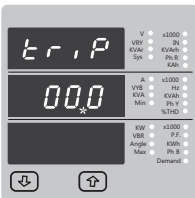

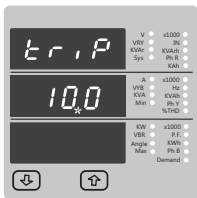

The first digit entered, prompt for second digit (\* Denotes that decimal point will be flashing).

Use the "↓ Down" key to scroll the value of the second digit

Press the "↑ Up" key to advance to next digit.

The second digit entered, prompt for third digit (\* Denotes that decimal point will be flashing).

Use the "↓ Down" key to scroll the value of the third digit

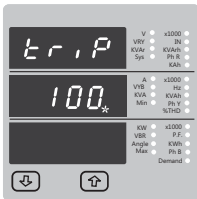

Entered the value for third digit .

Press the "↑ Up" key to advance to trip point confirmation Screen.

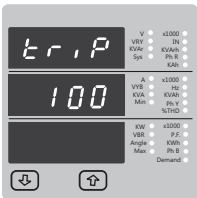

This Screen confirms the value set by user .

Press the "↑ Up" key to advance to next Screen "Hysteresis selection" ( see section 3.2.4.1.1.2.4)

Pressing the "↓ Down" key will return in edit mode

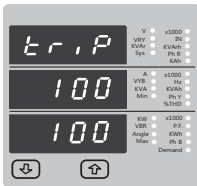

### 3.2.4.1.1.2.4 Hysteresis selection :

This screen applies to the Hysteresis selection.

This screen allows the user to set Hysteresis for relay1 output

The allowable range is 0.5% to 50 % of Trip point .

Enter value, prompt for first digit.

(\* Denotes that decimal point will be flashing).

Press the “**↓**Down” key to scroll the value of the first digit.

Press the “**↑**Up” key to advance to next digit.

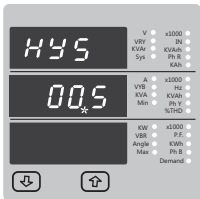
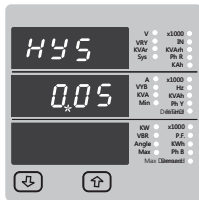

The first digit entered, prompt for second digit  
(\* Denotes that decimal point will be flashing).

Use the “**↓**Down” key to scroll the value of the second digit

Press the “**↑**Up” key to advance to next digit.

The second digit entered, prompt for third digit  
(\* Denotes that decimal point will be flashing).

Use the “**↓**Down” key to scroll the value of the third digit

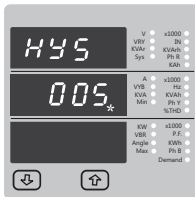

Entered value for third digit .

Press the “**↑Up**” key to advance to Hysteresis confirmation Screen.

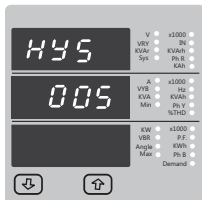
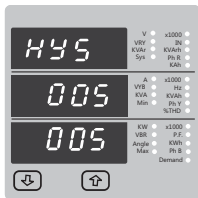

Hysteresis confirmation Screen.

This Screen confirms the percentage value set by user & Screen will appear only after edit mode of Hysteresis.

Press the “**↑Up**” key to advance to next Screen.  
“Energizing delay time” ( 3.2.4.1.1.2.5 )

### 3.2.4.1.1.2.5 Energizing Delay time.

This screen allows the user to set Energizing Delay time for Relay 1 Limit Assigned Parameters.

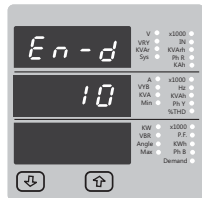

Pressing “**↑Up**” key accepts the present value and advance to De-energizing delay screen

Pressing the “**↓Down**” key will enter the “Energizing Delay” Edit mode and scroll the “Value” through 1 to10

### Energizing delay time Confirmation.

This screen will appear only after edit mode of Energizing delay time

pressing the "↓ Down" key will re-enter the "Energizing delay Edit" mode.

Pressing "↑ Up" key set displayed value and will advance to Assignment of De-energizing delay time. (See section 3.2.4.1.1.2.6 )

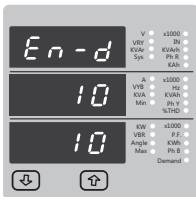

### 3.2.4.1.1.2.6 De-Energizing Delay time.

This screen allows the user to set De-Energizing Delay time for Relay 1 Limit Assigned Parameters.

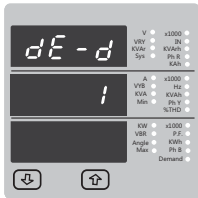

Pressing "↑ Up" key accepts the present value and advance to Configuration of Output. (See section 3.2.4.1 )

Pressing the "↓ Down" key will enter the "De-Energizing Delay" Edit mode and scroll the "Value" through 1 to 10

### De-Energizing delay time Confirmation.

This screen will appear only after edit mode of De-energizing delay time.

Pressing the "↓ Down" key will re-enter the "De-energizing delay Edit" mode.

Pressing "↑ Up" key set displayed value and will advance to Configuration of Output.(See section 3.2.4.1 )

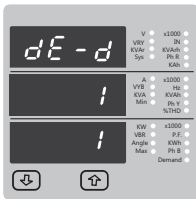

### 3.2.4.1.2 Relay 2 Output Selection :

Configuration of Relay 2 for Pulse or Limit Output is same as Relay 1. If you Select the Pulse output option for Relay 1 same setting will be applicable for Relay 2 except assignment of energy to Pulse output (i.e. Energy assignment of both relay can be different.)

### 3.2.4.1.3 Analog Output

#### 3.2.4.1.3.1 Parameter setting for Analog Output 1 (Optional)

This screen is for analog output 1 only . It allows the user to set analog output 1 to corresponding measured parameter . Refer table2 " Parameter for Analog & Limit output " .

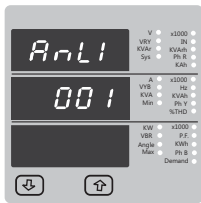

Pressing the "↑ Up" key accepts the present value and advance to the Analog output 2 selection (see section 3.2.4.1.3.2) .

Pressing the "↓ Down" key will enter the " Analog output 1 Edit" mode and scroll the values, as per Table 2 " Parameter for Analog & Limit output"

Pressing the "↑ Up" key advance to the Analog output 1 confirmation screen .

#### Analog output 1 Confirmation :

This Screen will appear only after edit mode of Analog output 1 Parameter.

Pressing the "↓ Down" key will re-enter the " Analog output 1 Edit"

Pressing the "↑ Up" key sets the displayed value and will advance to the Analog output 2 selection screen ( see section 3.2.4.1.3.2 )

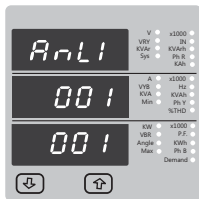

### 3.2.4.1.3.2 Parameter setting Analog Output 2 ( Optional )

This screen is for analog output 2 only . It allows the user to set analog output 2 to corresponding measured parameter . Refer table2 " Parameter for Analog & Limit output " .

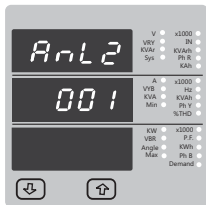

Pressing "⬆️ Up" key accepts the present value and advance to Analog output selection screen (see section 3.2.4.1 ).

Pressing the "⬇️ Down" key will enter the " Analog output 2 Edit" mode and scroll the values, as per Table 2. "Parameter for Analog output"

Pressing the "⬆️ Up" key advance to the Analog output 2 confirmation screen .

Analog output 2 Confirmation :

This Screen will appear only after edit mode of Analog output 2 Parameter.

Pressing the "⬇️ Down" key will re-enter the " Analog output 2 Edit"

Pressing the "⬆️ Up" key sets the displayed value and will advance to the Analog output selection screen (see section 3.2.4.1 ).

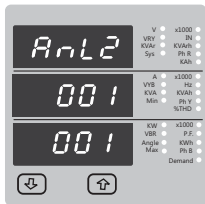



## 4.Phase Rotation Screen :

Meter shows phase rotation error if the phase sequence R-Y-B (L1-L2-L3) is not maintained

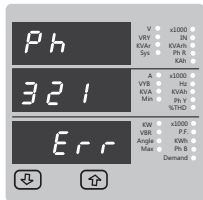

This screen indicates that Phase sequence is incorrect.

User must check this screen in order to get correct readings When meter is connected.

## Correct Phase sequence :

This Screen indicates the phase sequence connected to meter is correct. If phase sequence is wrong this screen is useful to get correct phase sequence by interchanging connection & verifying it with screen.

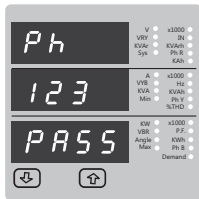

## 5. On Hour

This Screen shows the total no. of hours the Auxiliary Supply is ON.

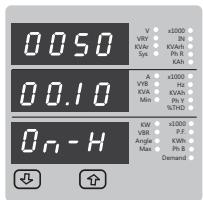

Even if the Auxiliary supply is interrupted count of On hour will be maintained in internal memory & displayed in the format "hours. min". For example if Displayed count is 005000.10 On-H it indicates 005000 hours & 10 minutes.

After 999999.59 On hours display will restart from zero. To reset On hour manually (see section Resetting Parameter )

## 6. Number of Interruption :

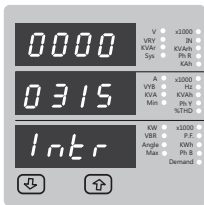

This Screen Displays the total no. of times the Axillary Supply was Interrupted. Even if the Auxiliary supply is interrupted count will be maintained in internal memory.

To reset No of Interruption manually see section Resetting Parameter 3.2.3.1

## 7. Analog Output ( optional ) :

This module provides two d.c. isolated outputs .There are two output options

- 1) Two 0 - 1mA outputs , internally powered .
- 2) Two 4 - 20mA outputs , internally powered .

The 0 -1mA output module has an 0V return on each end of the 4 way connector ( Please refer section 15 for connection details )

On both modules the output signals are present on pins A1(Analog Output 1) & A2 (Analog Output 2)

These outputs can be individually assigned to represent any one of the measured and displayed Parameters.

All settlings are user configurable via the user interface screen. See Analog o/p selection ( section 3.2.4.3 & section 3.2.4.4 ) for details .

**\* Note : Refer diagrams 1 & 2**

**Diagram 1 : ( 4 - 20 mA )**

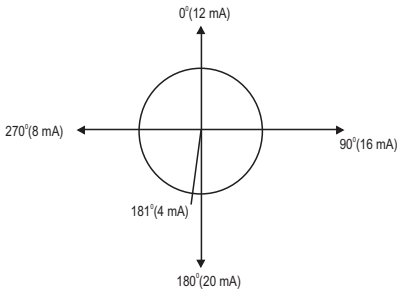

**Diagram 2 : ( 0 - 1 mA )**

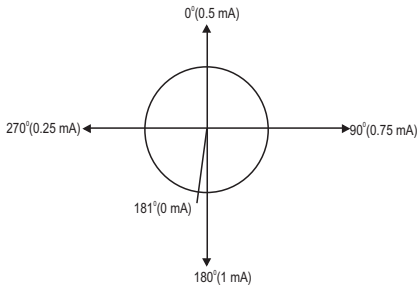

**TABLE 2 : Parameter for Analog & Limit Output**

Sr. No.	Parameter	1P 2W	3P 4W	3P 3W	Range	
					Analog Output	Limit Output
0	None	✓	✓	✓	–	–
1	INPUT VOLTAGE L1	✓	✓	✓	0 - 100 %	10 - 120 %
2	INPUT VOLTAGE L2	✗	✓	✓	0 - 100 %	10 - 120 %
3	INPUT VOLTAGE L3	✗	✓	✓	0 - 100 %	10 - 120 %
4	INPUT CURRENT IL1	✓	✓	✓	0 - 100 %	10 - 120 %
5	INPUT CURRENT IL2	✗	✓	✓	0 - 100 %	10 - 120 %
6	INPUT CURRENT IL3	✗	✓	✓	0 - 100 %	10 - 120 %
7	ACTIVE POWER L1	✓	✓	✗	0 - 120 %	10 - 120 %
8	ACTIVE POWER L2	✗	✓	✗	0 - 120 %	10 - 120 %
9	ACTIVE POWER L3	✗	✓	✗	0 - 120 %	10 - 120 %
10	APPARENT POWER L1	✓	✓	✗	0 - 120 %	10 - 120 %
11	APPARENT POWER L2	✗	✓	✗	0 - 120 %	10 - 120 %
12	APPARENT POWER L3	✗	✓	✗	0 - 120 %	10 - 120 %
13	REACTIVE POWER L1	✓	✓	✗	0 - 120 %	10 - 120 %
14	REACTIVE POWER L2	✗	✓	✗	0 - 120 %	10 - 120 %
15	REACTIVE POWER L3	✗	✓	✗	0 - 120 %	10 - 120 %
16	POWER FACTOR L1	✓	✓	✗	181 <sup>0</sup> / 0 / -180 <sup>0</sup>	10 - 100 % <sup>(2)</sup>
17	POWER FACTOR L2	✗	✓	✗	181 <sup>0</sup> / 0 / -180 <sup>0</sup>	10 - 100 % <sup>(2)</sup>
18	POWER FACTOR L3	✗	✓	✗	181 <sup>0</sup> / 0 / -180 <sup>0</sup>	10 - 100 % <sup>(2)</sup>
19	PHASE ANGLE L1	✓	✓	✗	181 <sup>0</sup> / 0 / -180 <sup>0</sup>	10 - 100 % <sup>(2)</sup>
20	PHASE ANGLE L2	✗	✓	✗	181 <sup>0</sup> / 0 / -180 <sup>0</sup>	10 - 100 % <sup>(2)</sup>
21	PHASE ANGLE L3	✗	✓	✗	181 <sup>0</sup> / 0 / -180 <sup>0</sup>	10 - 100 % <sup>(2)</sup>
22	VOLTAGE AVG	✗	✓	✓	0 - 100 %	10 - 120 %
24	CURRENT AVG	✗	✓	✓	0 - 100 %	10 - 120 %

Sr. No.	Parameter	1P 2W	3P 4W	3P 3W	Range	
					Analog Output	Limit Output
27	ACTIVE POWER SUM	x	✓	✓	0 - 120 %	10 - 120 %
29	APPARENT POWER SUM	x	✓	✓	0 - 120 %	10 - 120 %
31	REACTIVE POWER SUM	x	✓	✓	0 - 120 %	10 - 120 %
32	POWER FACTOR AVG	x	✓	✓	181 <sup>0</sup> / 0 / -180 <sup>0</sup>	10 - 100 % <sup>(2)</sup>
34	PHASE ANGLE AVG	x	✓	✓	181 <sup>0</sup> / 0 / -180 <sup>0</sup>	10 - 100 % <sup>(2)</sup>
36	FREQUENCY	✓	✓	✓	45 to 66 Hz	10 - 100 % <sup>(1)</sup>
43	WATT DEMAND IMPORT	✓	✓	✓	0 - 120 %	10 - 120 %
44	WATT MAX DEMAND IMP.	✓	✓	✓	0 - 120 %	10 - 120 %
45	WATT DEMAND EXPORT	✓	✓	✓	0 - 120 %	10 - 120 %
46	WATT MAX DEMAND EXP.	✓	✓	✓	0 - 120 %	10 - 120 %
51	VA DEMAND	✓	✓	✓	0 - 120 %	10 - 120 %
52	VA MAX DEMAND	✓	✓	✓	0 - 120 %	10 - 120 %
53	CURRENT DEMAND	✓	✓	✓	0 - 100 %	10 - 120 %
54	CURRENT MAX DEMAND	✓	✓	✓	0 - 100 %	10 - 120 %
101	INPUT VOLTAGE L12	x	✓	x	0 - 100 %	10 - 120 %
102	INPUT VOLTAGE L23	x	✓	x	0 - 100 %	10 - 120 %
103	INPUT VOLTAGE L31	x	✓	x	0 - 100 %	10 - 120 %
113	NEUTRAL CURRENT	x	✓	x	0 - 100 %	10 - 120 %

**Note :** Parameters 1,2,3 are L-N Voltage for 3P 4W & L-L Voltage for 3P 3W .

(1) For Frequency 0% corresponds to 40 Hz & 120% corresponds to 70 Hz.

(2) For Angle and PF 0% corresponds to 0 Deg. & 100% corresponds to 360 Deg.

## 8. Relay output (Optional) :

This instrument is provided with either 1 or 2 relay for pulse output as well as for limit switch

### 8.1 Pulse Output :

Pulse output is the potential free, very fast acting relay contact which can be used to drive an external mechanical counter for energy measurement.

This instrument's pulse output can be configured to any of the following parameter through setup parameter screen

- |                             |                             |
|-----------------------------|-----------------------------|
| 1) Active Energy (Import)   | 4) Reactive Energy (Export) |
| 2) Active Energy (Export)   | 5) Apparent Energy          |
| 3) Reactive Energy (Import) | 6) Ampere hour              |

**TABLE 3 : Energy Pulse Rate Divisor**

**1. For Energy Output in Wh**

Divisor	Pulse rate	
	Pulse	System Power*
1	1per Wh	Up to 3600W
	1per kWh	Up to 3600kW
	1per Mwh	Above 3600kW
10	1per 10Wh	Up to 3600W
	1per 10kWh	Up to 3600kW
	1per 10MWh	Above 3600kW
100	1per 100Wh	Up to 3600W
	1per 100kWh	Up to 3600kW
	1per 100MWh	Above 3600kW
1000	1 per 1000Wh	Up to 3600W
	1 per 1000kWh	Up to 3600kW
	1per 1000MWh	Above 3600kW
Pulse Duration 60 ms, 100 ms or 200 ms		

**2. For Energy Output in Kwh**

Divisor	Pulse rate	
	Pulse	System Power*
1	1 per kWh	Up to 3600W
	1 per 1000kWh	Up to 3600kW
	1 per 1000MWh	Above 3600kW

**3. For Energy Output in Mwh**

Divisor	Pulse rate	
	Pulse	System Power*
1	1 per Mwh	Up to 3600W
	1 per 1000Mwh	Up to 3600kW
	1 per 1000Gwh	Above 3600kW

Above options are also applicable for Apparent and Reactive Energy.

\* System power =  $3 \times CT(\text{Primary}) \times PT(\text{Primary})_{L-N}$  for 3 Phase 4 Wire

System power =  $\text{Root}3 \times CT(\text{Primary}) \times PT(\text{Primary})_{L-L}$  for 3 Phase 3 Wire

**Ampere Hour:** Divisor 1(Default)

CT secondary = 1A Max pulse rate 3600 pulses per Ah \*\*

CT secondary = 5A Max pulse rate 720 pulses per Ah \*\*

Divisors 10

CT secondary = 1A Max pulse rate 3600 pulses per 10Ah \*\*

CT secondary = 5A Max pulse rate 720 pulses per 10Ah \*\*

Divisors 100

CT secondary = 1A Max pulse rate 3600 pulses per 100Ah \*\*

CT secondary = 5A Max pulse rate 720 pulses per 100Ah \*\*

Divisors 1000

CT secondary = 1A Max pulse rate 3600 pulses per 1000Ah \*\*

CT secondary = 5A Max pulse rate 720 pulses per 1000Ah \*\*

Pulse duration 60 ms, 100 ms or 200 ms

\*\*No. of Pulses per Ampere hour = Maximum Pulses / CT Ratio Where, CT Ratio = (CT primary/ CT Secondary)

## 8.2 Limit Switch :

Limit switch can be used to monitor the measured parameter ( Ref.Table:2 )in relation with to a set limit.

The limit switch can be configured in one of the four mode given below:-

- 1) Hi alarm & Relay Energized Relay..
- 2) Hi alarm & De-Energized Relay.
- 3) Lo alarm & Energized Relay.
- 4) Lo alarm & De-Energized Relay.

Limit switch has user selectable Trip point, Hysteresis, Energizing Delay & De-Energizing delay.

### Hi Alarm:

If Hi-Alarm Energized or Hi Alarm De-Energized option is selected then relay will get energized or De-energized,if selected parameter is greater than or equal to trip point.

### Lo Alarm:

If Lo-Alarm Energized or Lo Alarm De-Energized option is selected then relay will get energized or De-energized,if selected parameter is less than or equal to trip point.

### Trip point:

Trip point can be set in the range of 10% to 120 % of nominal value for Hi-Alarm & 10% to 100 % of nominal value for Lo-Alarm.

### Hysteresis:

Hysteresis can be set in the range of 0.5% to 50 % of set trip point .

If Hi-alarm Energized or Hi-alarm De-energized is selected then relay will get De-energized or Energized respectively, if set parameter value is less than Hysteresis Similarly if Lo-alarm Energized or Lo-alarm De-Energized.

### Energizing Delay:

The energizing delay can be set in the range from 1 to 10 sec.

### De-Energizing Delay:

The De-energizing delay can be set in the range from 1 to 10 sec.

**Note :** In case of lo alarm if trip point is set at 100% then maximum 20% Hysteresis can be set..

Example of different configuration

Parameter No-41(Limit 1)

Set Point = 50%

Hysteresis = 20% of set point

Energizing Delay = 3s

De-energizing Delay = 3s

1) Hi alarm & Energized relay

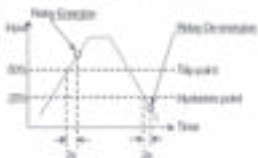

2) Hi alarm & De-energized relay

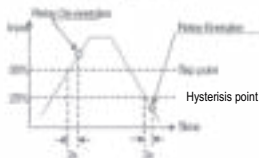



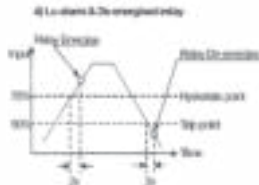
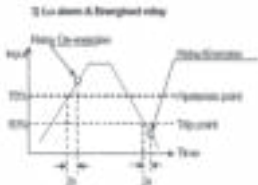

## 9. RS 485 ( ModBus ) Output :

This instrument supports MODBUS (RS485) RTU protocol( 2-wire ) .

Connection should be made using twisted pair shielded cable. All "A" and "B" connections are daisy chained together. The screens should also be connected to the "Gnd" terminal. To avoid the possibility of loop currents, an Earth connection should be made at one point on the network. Loop (ring) topology does not require any termination load. Line topology may or may not require terminating loads depending on the type and length of cable used. The impedance of the termination load should match the impedance of the cable and be at both ends of the line. The cable should be terminated at each end with a 120 ohm (1/4 Watt min.) resistor.

RS 485 network supports maximum length of 1.2km. Including the Master, a maximum of 32 instruments can be connected in Rs485 network. The permissible address range for the instrument is between 1 and 247 for 32 instruments. Broadcast Mode (address 0) is not allowed.

The maximum latency time for the instrument is 200ms i.e. this is the amount of time that can pass before the first response character is output.

After sending any query through software ( of the Master ) , it must allow 200ms of time to elapse before assuming that the instrument is not going to respond. If slave does not respond within 200 ms, Master can ignore the previous query and can issue fresh query to the slave.

The each byte in RTU mode has following format:

	8-bit binary, hexadecimal 0-9, A-F 2 hexadecimal characters contained in each 8-bit field of the message
<b>Format of Data Bytes</b>	4 bytes (32 bits) per parameter. Floating point format ( to IEEE 754) Most significant byte first (Alternative least significant byte first)
<b>Error Checking Bytes</b>	2 byte Cyclical Redundancy Check (CRC)
<b>Byte format</b>	1 start bit, 8 data bits, least significant bit sent first 1 bit for even/odd parity 1 stop bit if parity is used; 1 or 2 bits if no parity

Communication Baud Rate is user selectable from the front panel between 2400, 4800, 9600, 19200 bps.

**Function code :**

03	Read Holding Registers	Read content of read /write location ( 4X )
04	Read input Registers	Read content of read only location ( 3X )
16	Presets Multiple Registers	Set the content of read / write locations ( 4X )

**Exception Cases :** An exception code will be generated when the instrument receives ModBus query with valid parity & error check but which contains some other error ( e.g. Attempt to set floating point variable to an invalid value ) The response generated will be "Function code" Ored with HEX (80H ). The exception codes are listed below

01	Illegal function	This function code is not supported by the instrument.
02	Illegal Data Address	Attempt to access an invalid address or an attempt to read or write part of a floating point value
03	Illegal Data Value	Attempt to set a floating point variable to an invalid value

### Accessing 3 X register for reading measured values:

Two consecutive 16 bit registers represent one parameter. Refer table 4 for the addresses of 3X registers (Parameters measured by the instruments).

Each parameter is held in the 3X registers. Modbus Code 04 is used to access all parameters.

#### Example :

To read parameter ,

Volts 3 : Start address = 04 (Hex)      Number of registers = 02

#### Note : Number of registers = Number of parameters x 2

Each Query for reading the data must be restricted to 20 parameters or less. Exceeding the 20 parameter limit will cause a ModBus exception code to be returned.

#### Query :

01 (Hex)	04 (Hex)	00 (Hex)	04(Hex)	00 (Hex)	02(Hex)	30 (Hex)	0A (Hex)
Device Address	Function Code	Start Address High	Start Address Low	Number of Registers Hi	Number of Registers Lo	CRC Low	CRC High

Start Address High : Most significant 8 bits of starting address of the parameter requested.

Start Address low :Least significant 8 bits of starting address of the parameter requested.

Number of register Hi : Most significant 8 bits of Number of registers requested.  
 Number of register Lo : Least significant 8 bits of Number of registers requested.  
**(Note : Two consecutive 16 bit register represent one parameter.)**

**Response: Volt3 (219.25V)**

01 (Hex)	04 (Hex)	04 (Hex)	43 (Hex)	5B (Hex)	41 (Hex)	21 (Hex)	6F (Hex)	9B (Hex)
Device Address	Function Code	Byte Count	Data Register1 High Byte	Data Register1 Low Byte	Data Register2 High Byte	Data Register2 Low Byte	CRC Low	CRC High

Byte Count : Total number of data bytes received.

Data register 1 High Byte : Most significant 8 bits of Data register 1 of the parameter requested.

Data register 1 Low Byte : Least significant 8 bits of Data register 1 of the parameter requested.

Data register 2 High Byte : Most significant 8 bits of Data register 2 of the parameter requested.

Data register 2 Low Byte : Least significant 8 bits of Data register 2 of the parameter requested.

**(Note : Two consecutive 16 bit register represent one parameter.)**

**Table 4 : 3 X register addresses (measured parameters)**

Address (Register)	Sr. No.	Parameter	Modbus Start Address Hex		1P 2W	3P 4W	3P 3W
			High Byte	Low Byte			
30001	1	Volts 1	00	0	✓	✓	✓
30003	2	Volts 2	00	2	✗	✓	✓
30005	3	Volts 3	00	4	✗	✓	✓
30007	4	Current 1	00	6	✓	✓	✓
30009	5	Current 2	00	8	✗	✓	✓
30011	6	Current 3	00	A	✗	✓	✓
30013	7	W1	00	C	✓	✓	✗

Address (Register)	Sr. No.	Parameter	Modbus Start Address Hex		1P 2W	3P 4W	3P 3W
			High Byte	Low Byte			
30015	8	W2	00	E	✗	✓	✗
30017	9	W3	00	10	✗	✓	✗
30019	10	VA1	00	12	✓	✓	✗
30021	11	VA2	00	14	✗	✓	✗
30023	12	VA3	00	16	✗	✓	✗
30025	13	VAR1	00	18	✓	✓	✗
30027	14	VAR2	00	1A	✗	✓	✗
30029	15	VAR3	00	1C	✗	✓	✗
30031	16	PF1	00	1E	✓	✓	✗
30033	17	PF2	00	20	✗	✓	✗
30035	18	PF3	00	22	✗	✓	✗
30037	19	Phase Angle 1	00	24	✓	✓	✗
30039	20	Phase Angle 2	00	26	✗	✓	✗
30041	21	Phase Angle 3	00	28	✗	✓	✗
30043	22	Volts Ave	00	2A	✗	✓	✓
30045	23	Volts Sum	00	2C	✗	✓	✓
30047	24	Current Ave	00	2E	✗	✓	✓
30049	25	Current Sum	00	30	✗	✓	✓
30051	26	Watts Ave	00	32	✗	✓	✓
30053	27	Watts Sum	00	34	✗	✓	✓
30055	28	VA Ave	00	36	✗	✓	✓
30057	29	VA Sum	00	38	✗	✓	✓
30059	30	VAr Ave	00	3A	✗	✓	✓
30061	31	VAr Sum	00	3C	✗	✓	✓
30063	32	PF Ave	00	3E	✗	✓	✓
30065	33	PF Sum	00	40	✗	✓	✗

Address (Register)	Sr. No.	Parameter	Modbus Start Address Hex		1P 2W	3P 4W	3P 3W
			High Byte	Low Byte			
30067	34	Phase Angle Ave	00	42	✗	✓	✓
30069	35	Phase Angle Sum	00	44	✗	✓	✗
30071	36	Freq	00	46	✓	✓	✓
30073	37	Wh Import	00	48	✓	✓	✓
30075	38	Wh Export	00	4A	✓	✓	✓
30077	39	VARh Import	00	4C	✓	✓	✓
30079	40	VARh Export	00	4E	✓	✓	✓
30081	41	VAh	00	50	✓	✓	✓
30083	42	Ah	00	52	✓	✓	✓
30085	43	W Demand (Import)	00	54	✓	✓	✓
30087	44	W Max Demand (Import)	00	56	✓	✓	✓
30089	45	W Demand (Export)	00	58	✓	✓	✓
30091	46	W Max Demand (Export)	00	5A	✓	✓	✓
30101	47	VA Demand	00	64	✓	✓	✓
30103	48	VA Max Demand	00	66	✓	✓	✓
30105	49	A Demand	00	68	✓	✓	✓
30107	50	A Max Demand	00	6A	✓	✓	✓
30109	51	Wh Import Overflow Count	00	6C	✓	✓	✓
30111	52	Wh Export Overflow Count	00	6E	✓	✓	✓
30113	53	Varh Import Overflow Count	00	70	✓	✓	✓
30115	54	Varh Export Overflow Count	00	72	✓	✓	✓
30117	55	Vah Overflow Count	00	74	✓	✓	✓

Address (Register)	Sr. No.	Parameter	Modbus Start Address Hex		1P 2W	3P 4W	3P 3W
			High Byte	Low Byte			
30119	56	Ampere Hour Overflow Count	00	76	✓	✓	✓
30133	57	Volts Ave Max	00	84	✓	✓	✓
30135	58	Volts Ave Min	00	86	✓	✓	✓
30141	59	Current Ave Max	00	8C	✓	✓	✓
30143	60	Current Ave Min	00	8E	✓	✓	✓
30145	61	Wh Import (On Update Rate)	00	90	✓	✓	✓
30147	62	Wh Export (On Update Rate)	00	92	✓	✓	✓
30149	63	Varh Import (On Update Rate)	00	94	✓	✓	✓
30151	64	Varh Export (On Update Rate)	00	96	✓	✓	✓
30153	65	Vah (On Update Rate)	00	9A	✓	✓	✓
30197	66	Model Number	00	C4	✓	✓	✓
30199	67	Version Number	00	C6	✓	✓	✓
30201	68	VL 1 - 2 ( Calculated )	00	C8	✗	✓	✗
30203	69	VL 2 - 3 ( Calculated )	00	CA	✗	✓	✗
30205	70	VL 3 - 1 ( Calculated )	00	CC	✗	✓	✗
30207	71	V1 THD( % )	00	CE	✗	✓	✓
30209	72	V2 THD( % )	00	D0	✗	✓	✓
30211	73	V3 THD( % )	00	D2	✗	✓	✓
30213	74	I1 THD( % )	00	D4	✗	✓	✓
30215	75	I2 THD( % )	00	D6	✗	✓	✓
30217	76	I3 THD( % )	00	D8	✗	✓	✓
30219	77	System Voltage THD( % )	00	DA	✓	✓	✓

30221	78	System Current THD( % )	00	DC	✓	✓	✓
30225	79	l neutral	00	E0	✓	✓	✗
30227	80	Run Hour	00	E2	✓	✓	✓
30229	81	On Hour	00	E4	✓	✓	✓
30231	82	No. Of Interrupts	00	E6	✓	✓	✓

**Note :** Parameters 1,2,3 are L-N Voltage for 3P 4W & L-L Voltage for 3P 3W .

### Accessing 4 X register for Reading & Writing :

Each setting is held in the 4X registers .ModBus code 03 is used to read the current setting and code 16 is used to write/change the setting. Refer **Table 5** for 4 X Register addresses.

#### Example : Reading System type

System type : Start address = 0A (Hex)      Number of registers = 02

**Note :**Number of registers = Number of Parameters x 2

**Query :**

Device Address	01 (Hex)
Function Code	03 (Hex)
Start Address High	00 (Hex)
Start Address Low	0A (Hex)
Number of Registers Hi	00 (Hex)
Number of Registers Lo	02 (Hex)
CRC Low	E4 (Hex)
CRC High	09 (Hex)

Start Address High : Most significant 8 bits of starting address of the parameter requested.

Start Address low :Least significant 8 bits of starting address of the parameter requested.

Number of register Hi : Most significant 8 bits of Number of registers requested.

Number of register Lo : Least significant 8 bits of Number of registers requested.

**(Note : Two consecutive 16 bit register represent one parameter.)**



### Response: System Type ( 3phase 4 wire = 3 )

Device Address	01 (Hex)
Function Code	03 (Hex)
Byte Count	04 (Hex)
Data Register1 High Byte	40 (Hex)
Data Register1Low Byte	40 (Hex)
Data Register2 High Byte	00 (Hex)
Data Register2 Low Byte	00(Hex)
CRC Low	EE (Hex)
CRC High	27 (Hex)

Byte Count : Total number of data bytes received.

Data register 1 High Byte : Most significant 8 bits of Data register 1 of the parameter requested.

Data register 1 Low Byte : Least significant 8 bits of Data register 1 of the parameter requested.

Data register 2 High Byte : Most significant 8 bits of Data register 2 of the parameter requested.

Data register 2 Low Byte : Least significant 8 bits of Data register 2 of the parameter requested.

**(Note : Two consecutive 16 bit register represent one parameter.)**

### Example : Writing System type

System type : Start address = 0A (Hex)      Number of registers = 02

**Query:( Change System type to 3phase 3wire = 2 )**

Device Address	01 (Hex)
Function Code	10 (Hex)
Starting Address Hi	00 (Hex)
Starting Address Lo	0A(Hex)
Number of Registers Hi	00 (Hex)
Number of Registers Lo	02(Hex)

Byte Count	04 (Hex)
Data Register-1 High Byte	40 (Hex)
Data Register-1 Low Byte	00(Hex)
Data Register-2 High Byte	00(Hex)
Data Register-2 Low Byte	00(Hex)
CRC Low	66 (Hex)
CRC High	10 (Hex)

Byte Count : Total number of data bytes received.

Data register 1 High Byte : Most significant 8 bits of Data register 1 of the parameter requested.

Data register 1 Low Byte : Least significant 8 bits of Data register 1 of the parameter requested.

Data register 2 High Byte : Most significant 8 bits of Data register 2 of the parameter requested.

Data register 2 Low Byte : Least significant 8 bits of Data register 2 of the parameter requested.

**(Note : Two consecutive 16 bit register represent one parameter.)**

**Response:**

Device Address	01 (Hex)
Function Code	10 (Hex)
Start Address High	00 (Hex)
Start Address Low	0A(Hex)
Number of Registers Hi	00 (Hex)
Number of Registers Lo	02(Hex)
CRC Low	61 (Hex)
CRC High	CA (Hex)

Start Address High : Most significant 8 bits of starting address of the parameter requested.

Start Address low :Least significant 8 bits of starting address of the parameter requested.

Number of register Hi : Most significant 8 bits of Number of registers requested.

Number of register Lo : Least significant 8 bits of Number of registers requested.

**(Note : Two consecutive 16 bit register represent one parameter.)**

**Table 5 : 4 X register addresses**

Address (Register)	Parameter No.	Parameter	Read / Write	Modbus Start Address Hex	
				High Byte	Low Byte
40001	1	Demand Reset	R/Wp	00	00
40003	2	Demand Period	R/Wp	00	02
40005	3	Energy on RS485	R/Wp	00	04
40007	4	Sys Voltage	R	00	06
40009	5	Sys Current	R	00	08
40011	6	Sys Type	R/Wp	00	0A
40013	7	Pulse Width	R/Wp	00	0C
40015	8	Reset parameters	Wp	00	0E
40017	9	Run/On Hour & Interruption Reset	Wp	00	10
40019	10	RS 485 Set-up Code	R/Wp	00	12
40021	11	Node Address.	R/Wp	00	14
40023	12	Pulse Divisor	R/Wp	00	16
40025	13	Min Reset	Wp	00	18
40027	14	Max Reset	Wp	00	1A
40029	15	Analog Out 1- Para Sel	R/Wp	00	1C
40031	16	Analog Out 2- Para Sel	R/Wp	00	1E
40033	17	PT Primary	R/Wp	00	20
40035	18	CT Primary	R/Wp	00	22

Address (Register)	Parameter No.	Parameter	Read / Write	Modbus Start Address Hex	
				High Byte	Low Byte
40037	19	System Power	R	00	24
40039	20	Energy digit reset count	R/Wp	00	26
40041	21	Register Order/Word Order	R/Wp	00	28
40043	22	CT Secondary	R/Wp	00	2A
40045	23	PT Secondary	R/Wp	00	2C
40047	24	Relay1 output select	R/Wp	00	2E
40049	25	Pulse1/Limit1 Parameter select	R/Wp	00	30
40051	26	Limit1 Trip point	R/Wp	00	32
40053	27	Hysteresis(Limit1)	R/Wp	00	34
40055	28	Limit1 delay(On)	R/Wp	00	36
40057	29	Limit1 delay(Off)	R/Wp	00	38
40059	30	Relay2 output select	R/Wp	00	3A
40061	31	Pulse2/Limit2 Parameter select	R/Wp	00	3C
40063	32	Limit2 Trip point	R/Wp	00	3E
40065	33	Hysteresis(Limit2)	R/Wp	00	40
40067	34	Limit2 Delay(On)	R/Wp	00	42
40069	35	Limit2 Delay(Off)	R/Wp	00	44
40071	36	Password	R/W	00	46
40073	37	Limit1 Configuration select	R/Wp	00	48
40075	38	Limit2 Configuration select	R/Wp	00	4A
40077	39	Auto Scroll	R/Wp	00	4C
40079	40	30mA Noise Current Elimination	R/Wp	00	4E
40081	41	Energy Update Rate	R/Wp	00	50
40083	42	Model Number	R	00	52
40085	43	—	—	—	—
40087	44	—	—	—	—

Address (Register)	Parameter No.	Parameter	Read / Write	Modbus Start Address Hex	
				High Byte	Low Byte
40089	45	—	—	—	—
40091	46	—	—	—	—
40093	47	—	—	—	—
40095	48	—	—	—	—
40097	49	—	—	—	—
40099	50	—	—	—	—
40101	51	—	—	—	—
40103	52	—	—	—	—
40105	53	—	—	—	—
40107	54	Wh Import Start Count	R/Wp	00	6A
40109	55	Wh Export Start Count	R/Wp	00	6C
40111	56	Varh Import Start Count	R/Wp	00	6E
40113	57	Varh Export Start Count	R/Wp	00	70
40115	58	Vah Start Count	R/Wp	00	72
40117	59	Ampere Hour Start Count	R/Wp	00	74
40119	60	Wh Import Overflow Start Count	R/Wp	00	76
40121	61	Wh Export Overflow Start Count	R/Wp	00	78
40123	62	Varh Import Overflow Start Count	R/Wp	00	7A
40125	63	Varh Export Overflow Start Count	R/Wp	00	7C
40127	64	Vah Overflow Start Count	R/Wp	00	7E
40129	65	Ampere Hour Overflow Start Count	R/Wp	00	80

## Explanation for 4 X register :

Address	Parameter	Description
40001	Demand Reset	Demand Reset is used to reset the Demand parameter. A value of zero must be Written to this register to reset the Demand period. Writing any other value will return an error.
40003	Demand Period	Demand period represents demand time in minutes. The applicable values are 8,15,20 or 30. Writing any other value will return an error.
40005	Energy display on Modbus	This address is used to set energy display on MODBUS in Wh, KWh & Mwh. Write one of the following value to this address. <b>1</b> = Energy in Wh. <b>2</b> = Energy in KWh. <b>3</b> = Energy in MWh.
40007	System Voltage	This address is read only and displays System Voltage
40009	System Current	This address is read only and displays System Current
40011	System Type	This address is used to set the System type. Write one of the following value to this address. <b>1</b> = 1 Phase 2 Wire (Read only for 1P2W) <b>2</b> = 3 Phase 3 Wire <b>3</b> = 3 Phase 4 Wire. Writing any other value will return error .
40013	Pulse Width of Relay	This address is used to set <b>pulse width</b> of the Pulse output. Write one of the following values to this address: <b>60</b> : 60 ms <b>100</b> : 100 ms <b>200</b> : 200 ms Writing any other value will return error .
40015	Reset Parameters	This address is used to reset the parameters by writing following. <b>0</b> : Energy reset <b>1</b> : Demand reset <b>2</b> : Sys. Min reset <b>3</b> : Sys. Max reset <b>4</b> : RUN/ON hour reset <b>5</b> : No. of intr. <b>6</b> : Reset all      Writing any other value will return an error.

Address	Parameter	Description
40017	Run/On Hour & Interruption reset	This address is used to reset the Run/On hour & number of Interruption . Write zero value to this register to reset the Run/On hour & number of Interruption. Writing any other value will return an error.
40019	Rs485 Set-up Code	This address is used to set the baud rate, Parity, Number of stop bits. Refer to Table 6 for details.
40021	Node Address	This register address is used to set Device address between 1 to 247 .
40023	Pulse Divisor	This address is used to set <b>pulse divisor</b> of the Pulse output. Write one of the following values to this address <b>for Wh</b> : <b>1</b> : Divisor 1 <b>10</b> : Divisor 10 <b>100</b> : Divisor 100 <b>1000</b> : Divisor 1000 & in KWh & MWh Divisor will be <b>1 default</b> Writing any other value will return an error. Pulse rate divisor is set to 1, when Energy on Rs485 is set to kWh or MWh.
40025	Min - Reset	This address is used to reset the Min parameters value. Write Zero value to this register to reset the Min parameters. Writing any other value will return an error.
40027	Max - Reset	This address is used to reset the Max parameters value. Write Zero value to this register to reset the Max parameters. Writing any other value will return an error.
40029	Analog Out 1- Para Set	This address is used to set the parameter for Analog Output 1. Write one of the parameter no. As per the options given in Table 2 for Analog & Limit Output Parameters. Writing any other value will return an error.

Address	Parameter	Description
40031	Analog Out 2-Para Set	This address is used to set the parameter for Analog Output 2.. Write one of the parameter no. As per the options given in Table 2 for Analog & Limit Output Parameters. Writing any other value will return an error.
40033	PT Primary	This address allows the user to set PT Primary value. The maximum settable value is 692.8kV L-L depends on the per phase 666.6MVA Restriction of power combined with CT primary
40035	CT Primary	This address allows the user to set CT Primary value. The maximum settable value is 9999 & also depends on the per phase 666.6MVA Restriction of power combined with PT primary
40037	Sys Power	System Power (Read Only) is the Nominal system power based on the values of Nominal system volts and Nominal system current.
40039	Energy digit Reset Count	This address is used to set the rollover count for energy. If Energy on Rs485 is in Wh rollover count can be from 7 to 14. If it is in KWh then rollover count can be from 7 to 12 & for MWh rollover count can be from 7 to 9.
40041	Word Order	Word Order controls the order in which the instrument receives or sends floating - point numbers:- normal or reversed register order. In normal mode, the two registers that make up a floating point numbers are sent most significant bytes first. In reversed register mode , the two registers that make up a floating point numbers are sent least significant bytes first. To set the mode, write the value '2141.0' into this register- the instrument will detect the order used to send this value and set that order for all ModBus transaction involving floating point numbers.



Address	Parameter	Description
40043	CT secondary	This address is used to read and write the CT secondary value write one of the following values to this address. 1=1A CT secondary 5=5A CT secondary writing any other value will return an error.
40045	PT secondary	This address is used to read and write the PT secondary value. The valid range for PT Secondary is 100 VLL to 600 VLL.
40047	Relay1 output select	This address is used to select the Relay 1 operation as pulse or Limit. write one of the following values to this address. 0 = Pulse output on Relay 1 128 (Decimal) = Limit output on Relay 1 writing any other value will return an error.
40049	Pulse 1 /Limit 1 parameter select	This address is used to assign the Parameter to Relay1 If Limit option is selected refer table 2 for parameter number & if Pulse option is selected then refer table 7.
40051	Limit1 Trip Point	This address is used to set the trip point in %. Any value between 10 to 100 for Lo- alarm & 10 to 120 for Hi-alarm can be written to this address. Writing any other value will return an error.
40053	Hysteresis (Limit 1)	This address is used to set the hysteresis between 0.5 to 50 . Writing any other value will return an error.
40055	Limit1 Energizing Delay	This address is used to set the Energizing delay between 1 to 10 . Writing any other value will return an error.
40057	Limit1 de-energizing Delay	This address is used to set the De-Energizing delay between 1 to 10 . Writing any other value will return an error.

Address	Parameter	Description
40059	Relay 2 output select	This address is used to select the Relay 2 operation as pulse or Limit. write one of the following values to this address. 0 = Pulse output on Relay 2 128 (decimal) = Limit output on Relay 2 writing any other value will return an error.
40061	Pulse 2/Limit 2 Parameter select	This address is used to assign the Parameter to Relay2 If Limit option is selected refer table 2 for parameter number & if Pulse option is selected then refer table 7.
40063	Limit 2 Trip point	This address is used to set the trip point in %. Any value between 10 to 100 for Lo- alarm & 10 to 120 for Hi-alarm can be written to this address. Writing any other value will return an error.
40065	Hysteresis (Limit 2)	This address is used to set the hysteresis between 0.5 to 50 . Writing any other value will return an error.
40067	Limit 2 Energizing delay	This address is used to set the Energizing delay between 1 to 10 . Writing any other value will return an error.
40069	Limit 2 De-Energizing delay	This address is used to set the De-Energizing delay between 1 to 10 . Writing any other value will return an error.
40071	Password	This address is used to set & reset the password. Valid Range of Password can be set is 0000 - 9999 . 1) If password lock is present & if this location is read it will return <b>zero</b> . 2) If Password lock is absent & if this location is read it will return <b>One</b> . 3) If password lock is present & to disable this lock first send valid password to this location then write "0000" to this location

Address	Parameter	Description
		<p>4) If password lock is present &amp; to modify 4X parameter first send valid password to this location so that 4X parameter will be accessible for modification.</p> <p>5) If for in any of the above case invalid password is send then meter will return exceptional error 2.</p>
40073	Limit1 Configuration Select	This address is used to set the Configuration for relay 1 see table 8 . Writing any other value will return an error.
40075	Limit2 Configuration Select	This address is used to set the Configuration for relay 2 see table 8 . Writing any other value will return an error.
40077	Auto Scroll	<p>This address is used to activate or de-activate the Auto Scroll Setting</p> <p>0-Deactivate</p> <p>1 (Decimal)-Activate</p> <p>Writing any other value will return an error.</p>
40079	30mA Noise current Elimination	<p>This address is used to activate or de-activate the 30 mA noise current elimination write</p> <p>0-Deactivate</p> <p>30 (Decimal)-Activate</p> <p>Writing any other value will return an error.</p>
40081	Energy Update Rate	Energy Update Rate is the time after which energy registers are updated. This time is user settable from 1 - 60 minutes.
40083	Model Number	This Address is Read Only. This Address shows the Model Number of the meter

Address	Parameter	Description
40089 to 40105	—	—
40107 to 40117	Energy Start Count	The user can set respective energy starting count in these registers (before the user can write values to these locations user needs to check register 40005 i.e Energy on RS485 and register 40036 i.e Energy digit reset count). Valid range is 0-9999999. For E.g if Energy on RS485 is in K and Energy digit reset count is 7 the start count should be in k and value should be less than 7 digits.
40119 to 40129	Energy Overflow Start Count	The user can set respective Energy Overflow starting count in these registers. Valid range is 0-9999999.

**Table 6 : RS 485 Set-up Code**

Baud Rate	Parity	Stop Bit	Decimal value
19200	NONE	01	12
19200	NONE	02	13
19200	EVEN	01	14
19200	ODD	01	15
9600	NONE	01	08
9600	NONE	02	09
9600	EVEN	01	10
9600	ODD	01	11
4800	NONE	01	04
4800	NONE	02	05
4800	EVEN	01	06
4800	ODD	01	07
2400	NONE	01	00
2400	NONE	02	01
2400	EVEN	01	02
2400	ODD	01	03

**NOTE :**

Codes not listed in the table above may give rise to unpredictable results including loss of communication. Excise caution when attempting to change mode via direct Modbus writes.

**Table 7 : Pulse1 & Pulse2 Configuration**

Code	Configuration
0	Import Active Energy
1	Export Active Energy
2	Import Reactive Energy
3	Export Reactive Energy
4	Apparent Energy
5	Ampere Hour

**Table 8 :Limit1 & Limit2 Configuration**

Code	Configuration
0	Hi- alarm & Energized relay
1	Hi- alarm & De-energized relay
2	Lo- alarm & Energized relay
3	Lo- alarm & De-energized relay

## 9.1 User Assignable Modbus Registers:

This instrument contains the 20 user assignable registers in the address range of 0x200 (30513) to 0x226 (30551) (see **Table 9**).

Any of the parameter addresses ( 3X register addresses Table 4)) accessible in the instrument can be mapped to these 20 user assignable registers.

Parameters (3X registers addresses ) that resides in different locations may be accessed by the single request by re-mapping them to adjacent address in the user assignable registers area.

The actual address of the parameters ( 3X registers addresses) which are to be assessed via address 0x200 to 0x226 are specified in 4x Register 0x200 to 0x213 (see **Table 10**).

**Table 9 : User Assignable 3X Data Registers**

Address (Register)	Parameter Number.	Assignable Register	Modbus Start Address (Hex)	
			High Byte	Low Byte
30513	257	Assignable Reg 1	02	00
30515	258	Assignable Reg 2	02	02
30517	259	Assignable Reg 3	02	04
30519	260	Assignable Reg 4	02	06
30521	261	Assignable Reg 5	02	08
30523	262	Assignable Reg 6	02	0A

Address (Register)	Parameter Number.	Assignable Register	Modbus Start Address (Hex)	
			High Byte	Low Byte
30525	263	Assignable Reg 7	02	0C
30527	264	Assignable Reg 8	02	0E
30529	265	Assignable Reg 9	02	10
30531	266	Assignable Reg 10	02	12
30533	267	Assignable Reg 11	02	14
30535	268	Assignable Reg 12	02	16
30537	269	Assignable Reg 13	02	18
30539	270	Assignable Reg 14	02	1A
30541	271	Assignable Reg 15	02	1C
30543	272	Assignable Reg 16	02	1E
30545	273	Assignable Reg 17	02	20
30547	274	Assignable Reg 18	02	22
30549	275	Assignable Reg 19	02	24
30551	276	Assignable Reg 20	02	26

**Table 10 : User Assignable mapping register ( 4X registers)**

Address (Register)	Parameter Number.	Mapping Register	Modbus Start Address (Hex)	
			High Byte	Low Byte
40513	257	Mapped Add for register #0x0200	02	00
40514	258	Mapped Add for register #0x0202	02	01
40515	259	Mapped Add for register #0x0204	02	02
40516	260	Mapped Add for register #0x0206	02	03
40517	261	Mapped Add for register #0x0208	02	04
40518	262	Mapped Add for register #0x020A	02	05
40519	263	Mapped Add for register #0x020C	02	06
40520	264	Mapped Add for register #0x020E	02	07

Address (Register)	Parameter Number.	Mapping Register	Modbus Start Address (Hex)	
			High Byte	Low Byte
40521	265	Mapped Add for register #0x0210	02	08
40522	266	Mapped Add for register #0x0212	02	09
40523	267	Mapped Add for register #0x0214	02	0A
40524	268	Mapped Add for register #0x0216	02	0B
40525	269	Mapped Add for register #0x0218	02	0C
40526	270	Mapped Add for register #0x021A	02	0D
40527	271	Mapped Add for register #0x021C	02	0E
40528	272	Mapped Add for register #0x021E	02	0F
40529	273	Mapped Add for register #0x0220	02	10
40530	274	Mapped Add for register #0x0222	02	11
40531	275	Mapped Add for register #0x0224	02	12
40532	276	Mapped Add for register #0x0226	02	13

### Example :

#### Assigning parameter to user assignable registers

To access the voltage2 (3X address 0x0002) and Power Factor1 (3X address 0x001E) through user assignable register assign these addresses to 4x register (Table 10 ) 0x0200 and 0x0201 respectively .

#### Assigning Query:

Device Address	01 (Hex)
Function Code	10 (Hex)
Starting Address Hi	02 (Hex)
Starting Address Lo	00 (Hex)
Number of Registers Hi	00 (Hex)*
Number of Registers Lo	02(Hex)*



Byte Count	04 (Hex)
Data Register-1 High Byte	00 (Hex)
Data Register-1 Low Byte	02 (Hex)
Data Register-2 High Byte	00 (Hex)
Data Register-2 Low Byte	1E (Hex)
CRC IOW	CB (Hex)
CRC High	07 (Hex)

**Voltage 2 \***  
**(3X Address 0x0002)**

**Power Factor 1 \***  
**(3X Address 0x001E)**

### Response :

Device Address	01 (Hex)
Function Code	10 (Hex)
Start Address High	02 (Hex)
Start Address Low	00 (Hex)
Number of Registers Hi	00 (Hex)
Number of Registers Lo	02 (Hex)
CRC Low	40 (Hex)
CRC High	70 (Hex)

### Reading Parameter data through User Assignable Registers:

In assigning query Voltage2 and Power Factor1 parameters were assigned to 0x 200 and 0x201(Table10) which will point to user assignable 3xregisters 0x200 and 0x202 (table9). So to read Voltage2 and PowerFactor1 data reading query should be as below.

**Query:**

Device Address	01 (Hex)
Function Code	04 (Hex)
Start Address High	02 (Hex)
Start Address Low	00 (Hex)
Number of Registers Hi	00 (Hex)
Number of Registers Lo	04 (Hex) **
CRC Low	F0 (Hex)
CRC High	71 (Hex)

Start Address High : Most significant 8 bits of starting address of User assignable register.

Start Address low :Least significant 8 bits of starting address of User assignable register.

Number of register Hi : Most significant 8 bits of Number of registers requested.

Number of register Lo : Least significant 8 bits of Number of registers requested.

**\*\*Note : Two consecutive 16 bit register represent one parameter.**

**Since two parameters are requested four registers are required**

Response : (Volt2 = 219.30 / Power Factor1 = 1.0)

Device Address	01 (Hex)
Function Code	04 (Hex)
Byte count	08 (Hex)
Data Register-1 High Byte	43 (Hex)
Data Register-1 Low Byte	5B (Hex)
Data Register-2 High Byte	4E (Hex)
Data Register-2 Low Byte	04 (Hex)

} Voltage 2 Data

Data Register-3 High Byte	3F (Hex)
Data Register-3 Low Byte	80 (Hex)
Data Register-4 High Byte	00 (Hex)
Data Register-4 Low Byte	00 (Hex)
CRC Low	79 (Hex)
CRC High	3F (Hex)

**Power Factor 1Data**

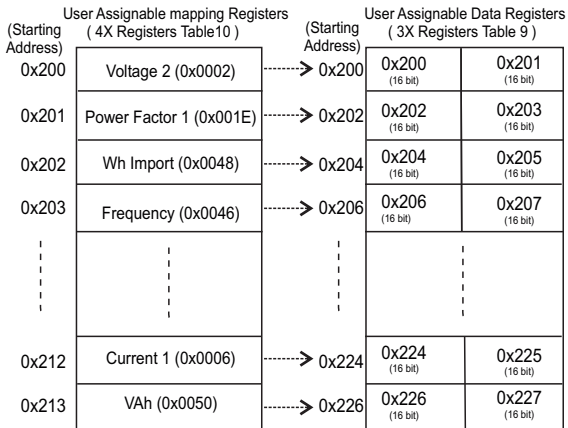

## To get the data through User assignable Register use following steps:

- 1) Assign starting addresses (Table 3) of parameters of interest to a "User assignable mapping registers" in a sequence in which they are to be accessed (see section "Assigning parameter to user assignable registers")
- 2) Once the parameters are mapped data can be acquired by using "User assignable data register" Starting address . i.e to access data of Voltage2, Power factor1, Wh import, Frequency send query with starting address 0x200 with number of register 8 or individually parameters can be accessed for example if current1 to be accessed use starting address 0x212.  
(See section Reading Parameter data through User Assignable Registers)

## 10. Phasor Diagram :

**Quadrant 1:**  $0^\circ$  to  $90^\circ$

**Quadrant 3:**  $180^\circ$  to  $270^\circ$

**Quadrant 2:**  $90^\circ$  to  $180^\circ$

**Quadrant 4:**  $270^\circ$  to  $360^\circ$

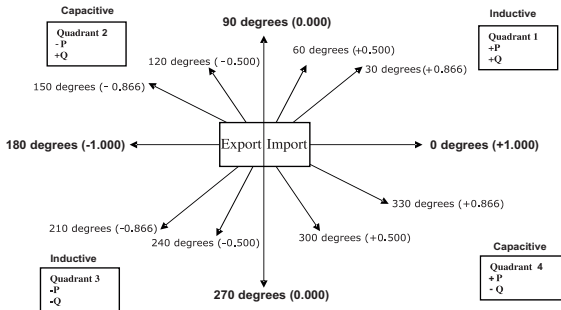

Connections	Quadrant	Sign of Active Power ( P )	Sign of Reactive Power ( Q )	Sign of Power Factor ( PF )	Inductive / Capacitive
Import	1	+ P	+ Q	+	L
Import	4	+ P	- Q	+	C
Export	2	- P	+ Q	-	C
Export	3	- P	- Q	-	L

**Inductive means Current lags Voltage**  
**Capacitive means Current leads Voltage**

When the instrument displays Active power ( P ) with “ + ” ( positive sign ) , the connection is “ **Import** ” .

When the instrument displays Active power ( P ) with “ - ” ( negative sign ) , the connection is “ **Export** ” .

## 11. Installation

Mounting is by four side clamps, slide the side clamps through side slot till side clamp gets firmly locked in a groove (Refer fig.) Consideration should be given to the space required behind the instrument to allow for bends in the connection cables.

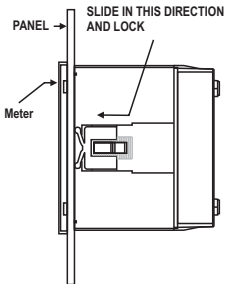

As the front of the enclosure conforms to IP54 it is protected from water spray from all directions, additional protection to the panel may be obtained by the use of an optional panel gasket. The terminals at the rear of the product should be protected from liquids.

The instrument should be mounted in a reasonably stable ambient temperature and where the operating temperature is within the range -10 to 55 °C . Vibration should be kept to a minimum and the product should not be mounted where it will be subjected to excessive direct sunlight.

### **Caution**

- 1. In the interest of safety and functionality this product must be installed by a qualified engineer, abiding by any local regulations.**
- 2. Voltages dangerous to human life are present at some of the terminal connections of this unit. Ensure that all supplies are de-energised before attempting any connection or disconnection.**
- 3. These products do not have internal fuses therefore external fuses must be used to ensure safety under fault conditions.**

## **11.1 EMC Installation Requirements**

This product has been designed to meet the certification of the EU directives when installed to a good code of practice for EMC in industrial environments, e.g.

1. Screened output and low signal input leads or have provision for fitting RF suppression components, such as ferrite absorbers, line filters etc., in the event that RF fields cause problems.

**Note:** It is good practice to install sensitive electronic instruments that are performing critical functions, in EMC enclosures that protect against electrical interference which could cause a disturbance in function.

2. Avoid routing leads alongside cables and products that are, or could be, a source of interference.

- To protect the product against permanent damage, surge transients must be limited to 2kV pk. It is good EMC practice to suppress differential surges to 2kV at the source. The unit has been designed to automatically recover in the event of a high level of transients. In extreme circumstances it may be necessary to temporarily disconnect the auxiliary supply for a period of greater than 5 seconds to restore correct operation.

The Current inputs of these products are designed for connection in to systems via Current Transformers only, where one side is grounded.

- ESD precautions must be taken at all times when handling this product.

## 11.2 Case Dimension and Panel Cut Out

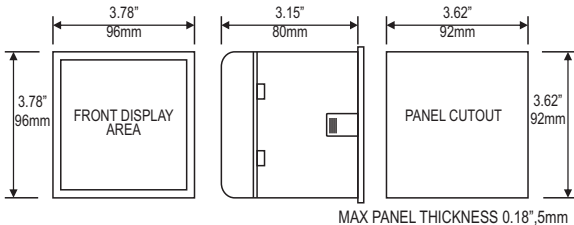

## 11.3 Wiring

Input connections are made directly to screw-type terminals with indirect wire pressure. Numbering is clearly marked in the plastic moulding. Choice of cable should meet local regulations. Terminal for both Current and Voltage inputs will accept upto 3mm<sup>2</sup> x 2 diameter cables.

**Note :** It is recommended to use wire with lug for connection with meter.

## 11.4 Auxiliary Supply

The instruments should ideally be powered from a dedicated supply, however it may be powered from the signal source, provided the source remains within the limits of the chosen auxiliary voltage.

## 11.5 Fusing

It is recommended that all voltage lines are fitted with 1 amp HRC fuses.

## 11.6 Earth/Ground Connections

For safety reasons, CT secondary connections should be grounded in accordance with local regulations.

## 12. Connection Diagrams

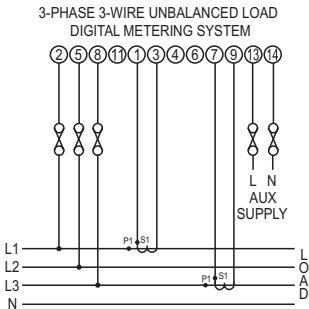



3-PHASE 4-WIRE UNBALANCED LOAD  
DIGITAL METERING SYSTEM

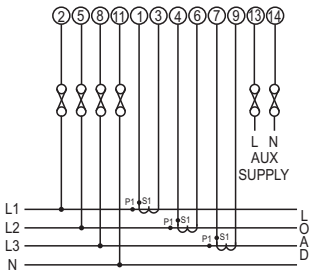

SINGLE PHASE  
DIGITAL METERING SYSTEM

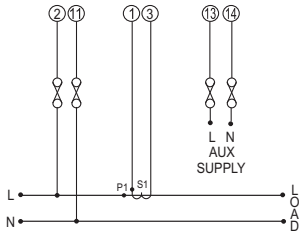

### 13. Specification :

#### System

3 Phase 3 Wire / 3 phase 4 Wire programmable at site

1 Phase 2 Wire as per order

#### Inputs

Nominal input voltage (AC RMS)	Phase-Neutral 57.7 - 346 $V_{L-N}$ Line-Line 100 - 600 $V_{L-L}$
Max continuous input voltage	120% of Rated Value
Max short duration input voltage	2 x Rated Value (1s application repeated 10 times at 10s intervals)
Nominal input voltage burden	0.35 VA approx. per phase
Nominal input current	1A / 5A AC rms
Max continuous input current	120% of Rated Value
Nominal input current burden	0.3VA approx. per phase
Max short duration current input	20 x Rated Value (1s application repeated 5 times at 5 min. intervals)
System CT primary values	Std. Values from 1 to 9999A (1 or 5 Amp secondaries)

#### Auxiliary

Standard nominal Auxillary supply voltages & Frequency	60 - 300 V AC- DC OR 65 - 300 V AC- DC with Ethernet / Analog Output 12 - 60 V AC - DC
a.c. supply frequency range	45 to 66 Hz
a.c. supply burden	5 VA approx. 7 VA approx. with Ethernet / Analog Output
d.c. supply burden	4 W approx. 5 W approx. with Ethernet / Analog Output

## Operating Measuring Ranges

Voltage	10 .. 120 % of Rated Value
Current	5 .. 120 % of Rated Value
Frequency	40 .. 70 Hz
Power Factor	0.5 Lag ... 1 ... 0.8 Lead

## Accuracy

### Accuracy 1:

Voltage	± 0.5 % of range
Current	± 0.5 % of range
Frequency	± 0.15% of mid frequency
Active Power	± 0.5 % of range
Re- Active Power	± 0.5 % of range
Apparent Power	± 0.5 % of range
Active Energy	± 1.0 % of range
Re - Active Energy	± 1.0 % of range
Apparant Energy	± 1.0 % of range
Power Factor	± 1 % of Unity
Angle	± 1 % of range
Analog Output	± 1 % of Output end value
Total Harmonic Distortion	± 1 %
Neutral Current	± 4 % of range.

### Accuracy 0.5:

Voltage	± 0.5 % of range
Current	± 0.5 % of range
Frequency	± 0.15% of mid frequency
Active Power	± 0.5 % of range
Re- Active Power	± 0.5 % of range
Apparent Power	± 0.5 % of range
Active Energy	± 0.5 % of range

Re - Active Energy	± 0.5 % of range
Apparent Energy	± 0.5 % of range
Power Factor	± 1 % of Unity
Angle	± 1 % of range
Analog Output	± 1 % of Output end value
Total Harmonic Distortion	± 1 %
Neutral Current	± 4 % of range

### **Accuracy 0.2:**

Voltage	± 0.2 % of range
Current	± 0.2 % of range
Frequency	± 0.15% of mid frequency
Active Power	± 0.2 % of range
Re- Active Power	± 0.4 % of range
Apparent Power	± 0.2 % of range
Active Energy	± 0.2 % of range
Re - Active Energy	± 0.5 % of range
Apparant Energy	± 0.2 % of range
Power Factor	± 1 % of Unity
Angle	± 1 % of range
Analog Output	± 1 % of Output end value
Total Harmonic Distortion	± 1 %
Neutral Current	± 4 % of range

### **Reference conditions for Accuracy :**

Reference temperature	23 °C ± 2 °C
Input frequency	50 or 60Hz ± 2%
Input waveform	Sinusoidal (distortion factor 0.005)
Auxiliary supply voltage	Rated Value ± 1 %
Auxiliary supply frequency	Rated Value ± 1 %
Voltage Range	50... 100% of Nominal Value. 60... 100% of Nominal Value for THD.

Current Range	10... 100% of Nominal Value. 20... 100% of Nominal Value for THD.
Power	$\cos\phi / \sin\phi = 1$ For Active / Reactive Power & Energy 10... 100% of Nominal Current & 50... 100% of Nominal Voltage.
Power Factor / Phase Angle	40... 100% of Nominal Current & 50... 100% of Nominal Voltage.

### **Nominal range of use of influence quantities for measurands**

Voltage	50 .. 120 % of Rated Value
Current	10 .. 120 % of Rated Value
Input frequency	Rated Value $\pm$ 10 %
Temperature	0 to 50 °C
Auxiliary supply voltage	Rated Value $\pm$ 10 %
Auxiliary supply frequency	Rated Value $\pm$ 10 %
Temperature Coefficient (For Rated value range of use 0... 50 °C )	0.025% / °C for Voltage (50..120% of Rated Value) 0.05% / °C for Current ( 10..120% of Rated Value )
Error change due to variation of an influence quantity	2 * Error allowed for the reference condition applied in the test.

### **Display**

LED	3 Line 4 Digits, (Digit Height 11mm)
Update	Approx. 1 seconds

### **Controls**

User Interface	Two Push Buttons
----------------	------------------

## Standards

EMC Immunity

IEC 61326

10V/m min-Level 3 industrial low level  
electromagnetic radiation environment

IEC 61000-4-3.

IEC 61010-1 , Year 2001

IEC 60529

Safety

IP for water & dust

## Isolation

Dielectric voltage withstand  
test between circuits and  
accessible surfaces

2.2 kV RMS 50 Hz for 1 minute  
between all electrical circuits

## Environmental

Operating temperature

-10 to 55 °C

Storage temperature

-20 to +65 °C

Relative humidity

0 .. 90 % RH

Warm up time

3 minute (minimum)

Shock

15g in 3 planes

Vibration

10 .. 55 Hz, 0.15mm amplitude

Enclosure ( front only )

IP 54 as per IEC 60529

## Enclosure

Style

96mm x 96mm DIN Quadratic

Material

Polycarbonate Housing ,

Terminals

Self extinguish & non dripping as per UL 94 V-0  
Screw-type terminals

Depth

< 80 mm

Weight

0.620 kg Approx.

## Pulse output Option ( 1 or 2 Relay ) :

Relay	1NO + 1NC
Switching Voltage & Current	240VDC , 5Amp.
Default Pulse rate Divisor	1 per Wh (up to 3600W), 1 per kWh (up to 3600kW), 1 per MWh (above 3600 kW)
Pulse rate Divisors	Programmable on site
10	1 per 10Wh (up to 3600W), 1 per 10kWh (up to 3600kW), 1 per 10MWh (above 3600 kW)
100	1 per 100Wh (up to 3600W), 1 per 100kWh (up to 3600kW), 1 per 100MWh (above 3600 kW)
1000	1 per 1000Wh (up to 3600W), 1 per 1000kWh (up to 3600kW), 1 per 1000MWh (above 3600 kW)
Pulse Duration	60ms , 100ms or 200ms

**Note : Above conditions are also applicable for Reactive & Apparent Energy .**

**Note : Pulse rate divisor is set to 1, when Energy on Rs485 is set to kWh or MWh.**

## ModBus ( RS 485 ) Option :

Protocol	ModBus ( RS 485 )
Baud Rate	19200 , 9600 , 4800 or 2400 ( Programmable )
Parity	Odd or Even, with 1 stop bit, Or None with 1 or 2 stop bits

## Analog Output Option :

Linear	0 ... 1mA dc into 0 - 2 kohm Uni-directional, internally powered . 4 ... 20mA dc into 0 - 500 ohm Uni-directional, internally powered.
--------	---

## 14. Connection for Optional Pulse Output / RS 485

/ Analog Output / Ethernet ( rear view of the instrument ) :

### 1. RS 485 Output + One Pulse (One Limit) + Two Analog Output

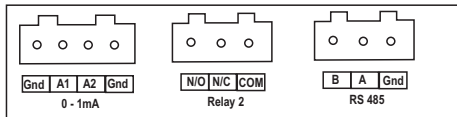

### 2. Two Pulse (Two Limit) + RS 485 Output

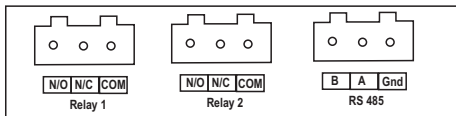

### 3. Ethernet

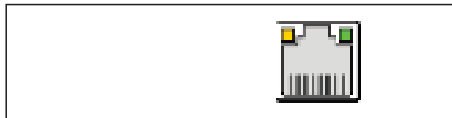



---

The Information contained in these installation instructions is for use only by installers trained to make electrical power installations and is intended to describe the correct method of installation for this product.

It is the user's responsibility to determine the suitability of the installation method in the user's field conditions.

---