



CONVERTER OF RS-485/ETHERNET INTERFACE PD8 TYPE



USER'S MANUAL



CONTENTS

1. APPLICATION.....	5
2. CONVERTER SET.....	10
3. BASIC REQUIREMENTS, OPERATIONAL SAFETY.....	10
4.INSTALLATION.....	11
4.1. Mounting.....	11
4.2 PD8 electrical connections.....	12
4.3 Connection way with devices.....	14
4.4. Transmission parameters of the serial interface.....	15
4.5 Converter configuration.....	16
4.5.1. Configuration via USB interface	17
4.5.2. Device configuration via LAN interface.....	20
5. PD8CONFIG APPLICATION.....	21
5.1. Installation of the application.....	21
5.2. Device configuration via LAN interface.....	21
5.3. Device configuration via USB interface.....	23
6. WEB BROWSER.....	27
6.1. Getting started with a web browser.....	27
6.2. Logging on.....	27
6.3. General appearance.....	28
6.4. Configuration.....	29
6.4.1. Network configuration	29
6.4.1.1. IP settings (Ethernet IP Settings).....	30

6.4.1.2. Network Services Settings.....	31
6.4.1.3. IP Forwarding Settings.....	32
6.4.1.4. Socket Tunnel Settings.....	34
6.4.1.5. Advanced Network Settings.....	35
6.4.2 Network Services Settings.....	36
6.4.3. I/O configuration (GPIO).....	38
6.4.4. Alarms configuration.....	38
6.4.5. System configuration.....	39
6.4.6. iDigi configuration.....	42
6.4.7. Users.....	43
6.5. Applications.....	45
6.5.1. RealPort.....	45
6.6. Management.....	47
6.6.1. Serial port management.....	47
6.6.2. Connection management.....	48
6.7. Administration.....	48
6.7.1. File management.....	48
6.7.2. Configuration Back-up/Restoring Configuration.....	49
6.7.3. Firmware update.....	50
6.7.4. Restoring default parameters.....	51
6.7.5. System Information.....	51
6.7.6. Rebooting.....	51
6.8. Logging a user out.....	52
7. OPERATING MODE WITH REALPORT SERVICE.....	52
7.1. RealPort service driver file information.....	53
7.2. Example of driver installation in Windows XP.....	53
7.3. RealPort driver configuration in Windows XP.....	54

8. SERIAL BRIDGE MODE WITH THE UDP PROTOCOL.....	56
8.1. Determination of serial link transmission parameters.....	57
8.2. Configuration of client service operation.....	57
9. OPERATING MODE WITH TCP SOCKET SERVICE.....	60
10. TECHNICAL DATA.....	63
11. ORDERING CODE PD8.....	65
12. MAINTENANCE AND SERVICE.....	66

1. APPLICATION

RS-485/Ethernet converter PD8 type allows master devices to transmit data via a wireless Ethernet network to the devices with RS-232 and RS-485 interface.

The converter has three operating modes: RealPort network service, serial bridge service with the UDP protocol, TCP Socket service. In the first and third mode, the switching master device of the system is a PC using Ethernet interface. In the second mode, the converter works with a device with Master function and RS-232 and RS-485 serial interfaces.

The converter PD8 to work with RealPort network service requires the installation of a virtual serial port driver on a PC with Microsoft Windows. Thanks to the PD8 type converters, this driver provides the existing master systems, the ability to transmit data between devices with RS-485 or RS-232 interface using Ethernet network (Fig. 1). When used in this way, the converter allows to work with one master computer in the given time. When using PD8 to support Modbus and Lumbus industrial protocols - its correct interaction with master systems installed on a PC depends on the built-in mechanisms to control time intervals between the received transmission characters.



Fig.1. Example application of the PD8 converter

Using PD8 in the second mode, the RS-485 bus can be expanded with successive segments using additional PD8 converters and Ethernet local network. Properly configured, one pair of converters allows to build a system working in the serial bridge mode (Fig. 2). It is also possible to configure their operation in „one-to-several” mode (as a set including up to 65 converters – Fig. 3). Function 2 of the converter operates in the Ethernet local network with UDP datagram protocol support.

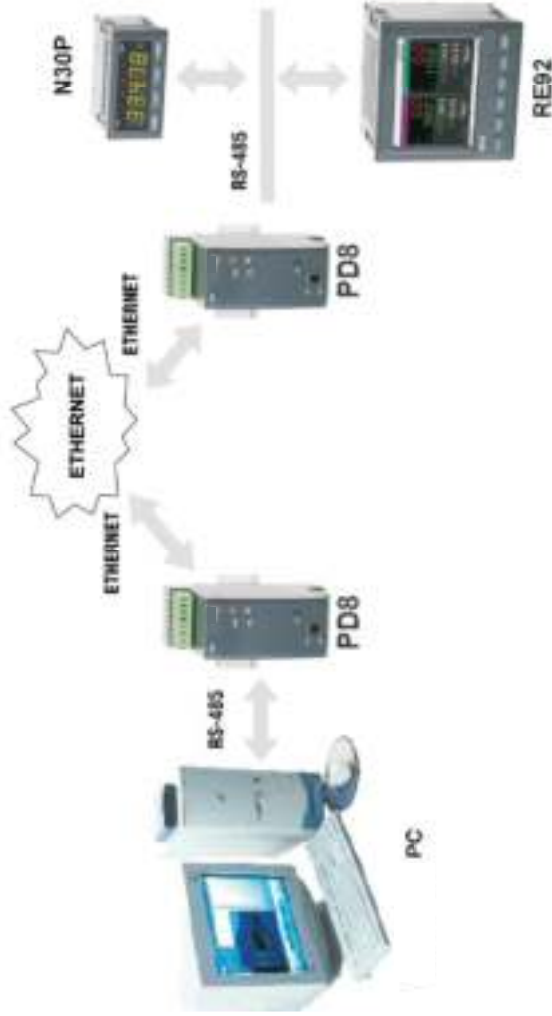

Fig.2. Example application of the PD8 converter, serial bridge mode with UDP protocol (point – point).

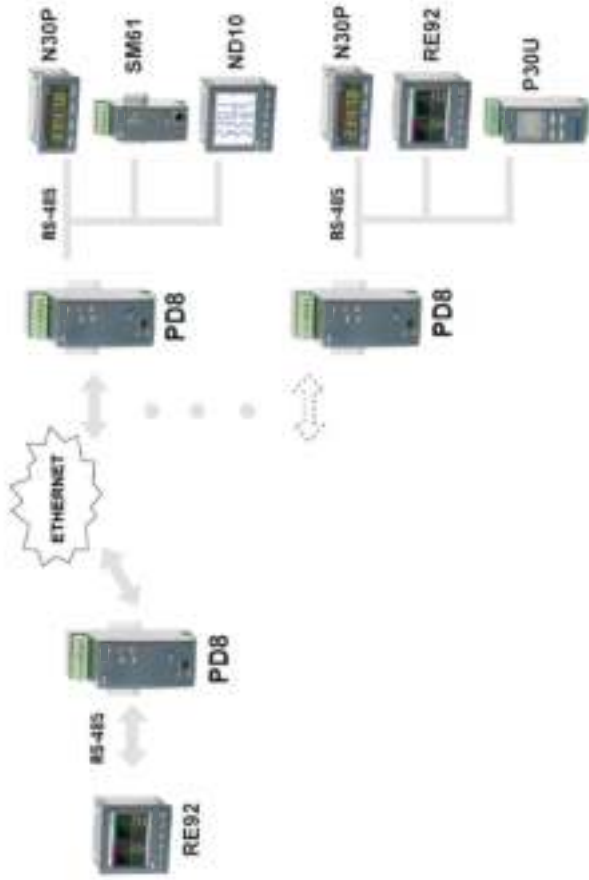

Fig.3. Example application of the PD8 converter, serial bridge mode with UDP protocol (point – multipoint).

Function 3 operation is very similar to the converter working with RealPort network service except that it is not required to install software virtual serial port driver on a PC with Windows. Communication between a PC and PD8 converter is via TCP Socket mechanism. (More details in paragraph 9. *Operating mode with TCP socket service*).

2. CONVERTER SET

Complete set of the converter includes:

- | | |
|---------------------|-------|
| - PD8 converter | 1 pc, |
| - PD8 user's manual | 1 pc, |
| - Warranty card | 1 pc, |
| - CD with software | 1 pc. |

3. BASIC REQUIREMENTS, OPERATIONAL SAFETY

Symbols located in this manual mean:



Especially important, please read before connecting the converter. Non-compliance with the comments marked by this symbol could result in damage to the converter.



Should pay attention, if the converter is not working as expected.

Caution:

Removal of the converter housing during the warranty period voids the warranty.



Comments concerning safety:

- Assembly and installation of the electrical connections should be conducted only by people authorised to perform assembly of electric devices.
- Always check the state of connections before turning



the converter on.

- Prior to taking the converter housing off, always turn the supply off and disconnect measuring circuits.
- The device is designed to installation and usage in the industrial electromagnetic environment.
- A switch or a circuit-breaker should be installed in the building or facility. It should be located near the device, easily accessible by the operator, and suitably marked.

4. INSTALLATION

4.1. Mounting

PD8 converter can be mounted on a 35 mm rail.

Dimensions and mounting are shown in Fig.4.

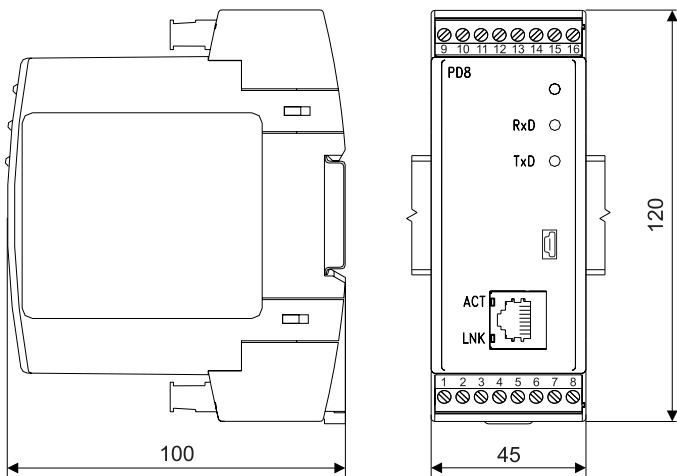

Fig.4. Overall dimensions.

4.2 PD8 electrical connections

The supply and external signals must be connected acc. to Fig. 5 and Fig.6. and the Table 1 in which the assignment of the particular leads-outs have been described.

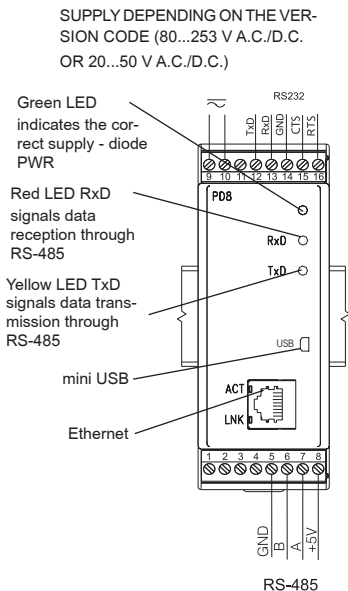

Fig.5. PD8 converter electrical connections

Description of the leads-out

Table 1

Terminal	Terminal description
5	GND line
6	Line B (RS-485 interface)
7	Line A (RS-485 interface)
8	Line 5 V d.c.
9	Line + supply
10	Line - supply
11	not used
12	TxD output (RS-232 interface)
13	RxD input (RS-232 interface)
14	GND line
15	CTS line (RS-232 interface)
16	RTS line (RS-232 interface)

2 LEDs are located in the slot RJ-45 Ethernet interface:

- green (ACT) – signaling device network activity (transmission or reception),
- orange (LNK) – signals an active network connection.

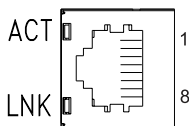

Fig.6. Frontal view of the RJ-45 Ethernet interface socket

Description of RJ-45 socket signals Table 2

No	Signal	Description
1	TX+	Transmission +
2	TX-	Transmission -
3	RX+	Reception +
4	EPWR+	(not used)
5	EPWR+	(not used)
6	RX-	Reception -
7	EPWR-	(not used)
8	EPWR-	(not used)



Caution:

In order to obtain full immunity of the converter against electromagnetic noise in an environment, it is recommended to observe the following principles:

- do not supply the converter from the network in the proximity of devices generating high pulse noises (inverters) and do not apply common earthing circuits,
- apply network filters,
- all shields should be one-side earthed or connected to the protection wire, the nearest possible to the converter,
- **as a rule of thumb, wires transmitting different signals should be spaced as far as it is possible (at least 30 cm) and should be crossed only at the right angle of 90°.**

4.3 Connection way with devices

The fig. 7 presents the manner of PD8 converter connection with devices from the object side with RS-485 interface and the computer equipped with Ethernet interface. For the Ethernet interface, the twist of STP type (screened) of category 5, should be set with RJ-45 plugs and the wire colouring (in accordance with the table 3) in the following standard:

- EIA/TIA 568A for both plugs, in so-called direct connection of PD8 to the network concentrator (hub), or network switch (switch).
- EIA/TIA 568A for the first plug or EIA/TIA 568B for the second plug in so-called connection with a cross-over transposition, applied among other things in the direct PD8 connection to the computer.

Wire colouring in RJ-45 plug

Table 3

Wire No	Signal	Wire colour in accordance with standard	
		EIA/TIA 568A	EIA/TIA 568B
1	TX+	White-green	White-orange
2	TX-	Green	Orange
3	RX+	White-orange	White-green
4	EPWR+	Blue	Blue
5	EPWR+	White-blue	White-blue
6	RX-	Orange	Green
7	EPWR-	White-brown	White-brown
8	EPWR-	Brown	Brown

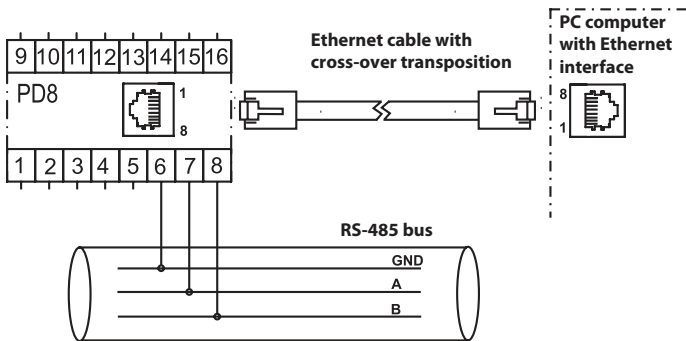

Fig.7 Example of PD8 converter connection.

4.4. Transmission parameters of the serial interface

The PD8 converter co-operates from the RS-485 side with industrial devices at following baud rates: 300 bit/s, 600 bit/s, 1200 bit/s, 2400 bit/s, 4800 bit/s, 9600 bit/s, 19200 bit/s, 38400 bit/s, 56000 bit/s, 115200 bit/s. Maximal serial baud rates depend on the length of transmission lines and are presented on the table 4. At a length over 800 m one must apply a terminator (a 120 Ohm resistance) which connects terminals „A” and „B” of the PD8 converter.

Dependence of maximal baud rate from the line length

Table 4

Length of the transmission line	Maximal baud rate	Notes
100 m	115200 bit/s	Without a terminator
200 m	56000 bit/s	Without a terminator
800 m	38400 bit/s	With a terminator for baud rate >9600 bit/s
1200 m	9600 bit/s	With a terminator

4.5 Converter configuration



Caution:

Initial start of the device requires to configure the basic parameters.

The default settings of a delivered device are shown in the Table 5.

Default settings

Table 5

RS-485	
Address	1
Mode	RTU 8N1
Baud rate	9600 bit/s
RS-232	
Mode	RTU 8N1
Baud rate	9600 bit/s
USB	
Address	1
Mode	RTU 8N1
Baud rate	9600 bit/s
LAN interface	
IP address	192.168.1.1
Mask	255.255.255.0
Gateway address	0.0.0.0
LAN baud rate	Auto

The PD8 converter requires to configure the settings appropriate for IP network protocol and local area network at the initial start. The settings that must be configured are: IP address of the PD8 converter, subnet mask, address of the default gateway. This data should be obtained from the administrator of the computer network which PD8 is connected to.

When the converter is connected to the local area network with DHCP service available, IP settings of PD8 will be configured automatically. Configuration of settings to allow the converter connecting to a wireless local area network is possible via the USB interface.

Converter versions without USB input have to be configured through Ethernet.

4.5.1. Configuration via USB interface

The converter is configured by default to communicate through a USB port.

To configure the device via a USB interface it should be connected to the PC with a mini-USB cable. After connecting the converter, the operating system will inform that a new device is found with a message shown in Fig. 8. Found New Hardware Wizard of the Universal Serial Bus will be started automatically. Follow the suggestions of the wizard by selecting the installation from a specific location and providing a path to the drivers included on the supplied CD. Drivers are compatible with the following systems: Windows 2000, XP, Server 2003, Vista, Windows 7, Server 2008 (x86 and x64). When installing the drivers, you may receive information about missing digital signature for drivers. Please ignore it and continue with the installation.



Fig. 8: The message to indicate that a new hardware has been found.

After closing the wizard, the system immediately will detect another device – USB Serial Port (Fig. 9). Found New Hardware Wizard will be restarted. Follow the suggestions of the wizard during installation.



Fig. 9: System message about finding a new device.

After a successful installation, the system will inform that new hardware has been installed (Fig. 10). There will be two new devices visible in Device Manager – **Converter ETH-RS485 PD8** and COM port named: **Converter ETH-RS485 PD8**, as shown in Fig. 11.



Fig. 10: The system message ending PD8Wdriver installation.

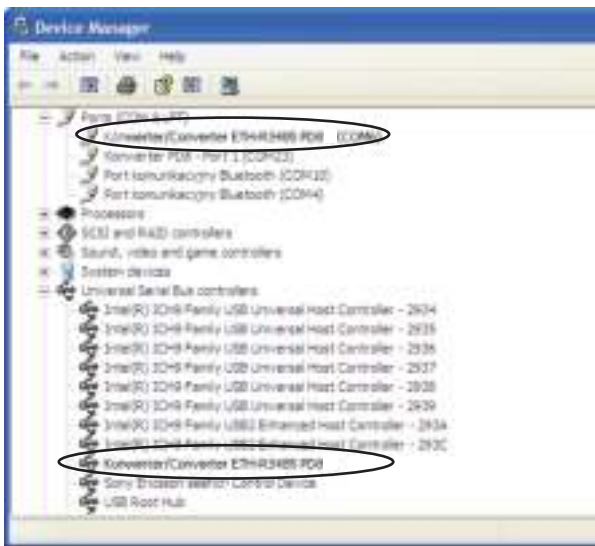

Fig. 11: Device Manager window with the PD8 converter installed

Then, run the PD8WConfig program delivered on CD and follow the installation instructions provided in point 5.1. *Installation of the application* and instructions for configuration via USB interface provided in point 5.3 *Device configuration via USB interface*.

After entering the configuration, save it and restart the device for the new configuration to take effect.



Caution:

After changing the parameters it is necessary to reset a device.

4.5.2. Device configuration via LAN interface

Configuration of the PD8 converter via the LAN interface is possible after connecting it to the local network.

If the network to which the converter is to be connected has a different settings than the converter defaults, use the USB interface (see section 4.4.1. *Configuration via USB interface*) to adjust the converter to work in this network. Then you can continue working.

PD8 converter is configured by default to obtain IP settings through DHCP. If the local network to which the converter is connected to provides the DHCP service, the converter will automatically obtain appropriate IP settings of this network. Please note, that the IP address allocated by the DHCP protocol can be changed dynamically.

Use the PD8WConfig program included on the CD to set the IP address, as shown in section 5.2 *Device configuration via LAN interface*.

If the IP address is known it is possible to configure the converter via the website, as shown in section 6. *Web browser*.

5. PD8CONFIG APPLICATION

The PD8Config program included in the set is used to search for devices on a network, configure the PD8 converter network settings and configuration via a USB interface.

It is required to enter the password for the administrator account to make any changes to the configuration of the converter. The default password for the administrator account is:

dbps

More about user accounts in section 6.4.7 *Users*.

Converter versions without USB input have to be configured through Ethernet.

5.1. Installation of the application

The installation program is included on the CD that came with the converter. Run the program PD8Config_install_vX.X.X.exe to start the installation. It is an application that installs PD8Config program on your computer, and the necessary software additions. Follow the instructions on the screen during installation.

5.2. Device configuration via LAN interface

The program scans a local area network and creates a list of available converters of PD8 and PD8 series. This list is displayed in the field *List of Converters* (Fig. 12).



Fig 12: The list of available converters.

The current IP address of the converter is shown in the field IP Address. If you can see that the converter has a wrong IP address such as 0.0.0.0, this means that the network has no DHCP service available. In such case, you must configure PD8 with wrong address manually as follows:

1. After selecting the converter, click *Configure IP settings*.
2. In the window Set IP Address fill in the data obtained from the network administrator (Fig. 11). As the password, enter the password for the administrator account which by default is set to: dbps

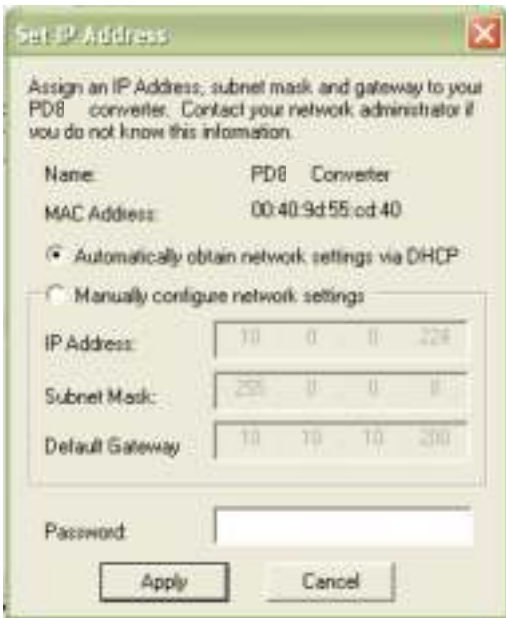

Fig. 13: Configuration of network settings

3. After pressing the *Apply* key wait until the message *Operation carried out successfully* will appear. After confirming the message, click *Refresh list* command in the main window. The list of available converters will be updated after a moment.

The command *Reboot PD8* restarts the selected device. After changing the configuration a restart will introduce new settings to the device. An unconditional restart of PD8 can be also performed by pressing the button accessible through a hole in the converter housing, after removing the upper terminal 13 - 16.

When using the PD8Config program, you can easily display a webpage of a selected PD8 converter. To do this, after selecting the converter from the list, click *Open the webpage*, to launch the default web browser, which is standard on modern computer. More information about working with a web browser can be found in Chapter 6. *Web browser*.

5.3. Device configuration via USB interface

To configure the PD8 converter via the USB interface, the device must be connected via the USB cable to your PC and the drivers should be installed in accordance with section 4.4.1. *Device configuration via USB interface*.

Selecting the option *Configuration via USB* as shown in Fig. 14 lets you access the window, which allows a configuration via USB.



Fig. 14: Selecting the option Configuration via USB

The first step is to connect to the device, as shown in Fig. 15. To make a connection you must:

- choose a device from the list (a list of all converters currently connected via the USB interface);
- select transmission parameters, the default values are: baud rate 9600 bit/s and 8N1 mode;
- enter the login and password for the administrator account, the default login is root and the password dbps;
- click an option *Connect*.

Once connected to a device you will get a message about the connection status and error messages if any.

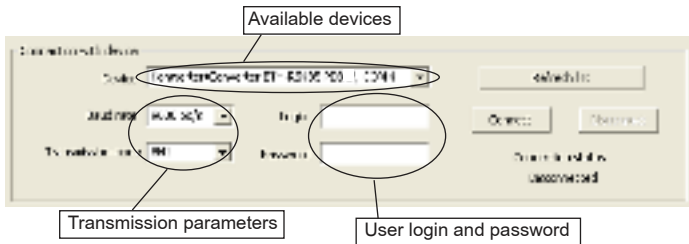

Fig. 15: Making connection to a device

After a successful connection to the device, you can read the configuration, save the configuration, reboot the device or check device information, Fig. 14. It is also possible to save the configuration to a file and read it from a file. After reading the configuration file, you can save it to the device. An option to read and write a configuration file is available from the menu Files. During configuration, you should keep in mind, that for the device to work in the network it must have the same settings as the local wireless network.

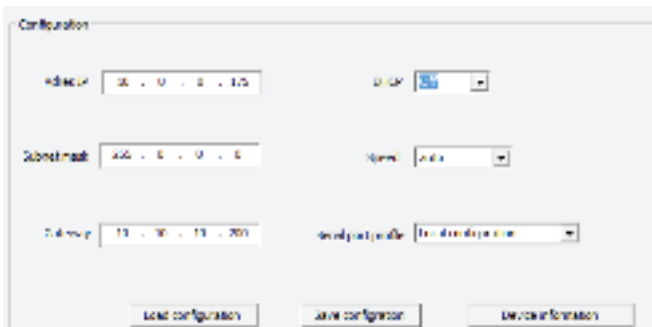

Fig. 16: PD8 converter configuration

Depending on selected options, the windows will be edited or blocked to allow the introduction of only those settings which are required for the configuration. Selecting the option *Download configuration* reads the current configuration of the device. Selecting the option

Save configuration saves the new configuration. It is recommended to restart the device after making changes in a configuration.

Selecting the option *Device information* brings up the window shown in Fig. 17 for checking the specific information about the device.



Caution:

After changing the parameters it is necessary to reset a device.



Fig. 17: The window with information about the converter

6. WEB BROWSER

PD8 converter allows you to configure and manage it via the website.

6.1. Getting started with a web browser

Access to the server can be achieved by entering the IP address of the converter in the web browser, for example: `http://192.168.1.1` (where 192.168.1.1 is an example of address of the converter). You can also use the PD8Config application to run a web browser as presented in section 5.2. *Device configuration via LAN interface.*

The PD8 converter requires to configure the necessary IP protocol settings at the initial start that is:

- IP address,
- subnet mask,
- address of the default gateway.

These data should be obtained from the administrator of the network which the converter will be connected to. Initial start of the converter must be carried out in accordance with section 4. *Installation.*

6.2. Logging on

To begin working with a browser, it is necessary to log on to the webpage. Please enter your login and user password. The converter has a default user:

- Username: root
- Password: dbps

When you open the browser for the first time, change the default login and password for security reasons (6.4.7. *Users*).

6.3. General appearance

The home page will be displayed after logging in as shown in Fig. 18.

Konverter PDB Configuration and Management

Home

- Configuration**
 - Network
 - Serial Ports
 - GPIO
 - Alarms
 - System
 - Diag.
 - Users
- Applications**
 - WebPort
- Management**
 - Serial Ports
 - Connections
- Administration**
 - Info Management
 - Backup/Restore
 - Update Firmware
 - Factory Default Settings
 - System Information
 - Reset

Logout

Home

Getting started

Tutorial: Not sure what to do next? This Tutorial can help.

System Summary

Model:	Konverter PDB
Ethernet Mac address:	08:00:00:00:00:00:00:00
Ethernet IP Address:	10.0.0.12
Link Local Address:	FE80::D43:DDFF:FE8B::C00C
Description:	None
Contact:	None
Location:	None
Device ID:	00000000-00000000-00400000-F7D0C00C

Fig.18. Home page (Home)

On the Fig. 17 you will notice that the navigation menu is on the left hand side. The home page includes the following:

- a. Getting Started - includes a link to the tutorial to help you navigate the webpage,
- b. System Summary - includes basic information about the device such as:
 - Model,
 - MAC Address,
 - IP Address,
 - Link Local Address,
 - Description,
 - Contact,
 - Location,
 - Device ID.

6.4. Configuration

The converter allows a user to configure the settings of a network, serial port, GPIO, alarms, system, iDigi and users.

6.4.1. Network configuration

The network settings in the converter can be done in two different ways. You can use the static or dynamic settings.

For static settings, all settings must be entered manually and they will be assigned on a permanent basis. To enter the correct values, please contact the administrator of the network which the converter will be connected to. Once set, the static settings will not change and the device can always be found by its IP address.

Dynamic settings will be automatically assigned by DHCP protocol. In this case, the IP address may change, so the connection with the configuration webpage can be broken. Please use the PD8Config application to search again for the device in such case.

The Fig. 19 shows a structure of the network configuration.



Fig. 19: Network configuration

6.4.1.1. IP settings (Ethernet IP Settings)

IP settings (Ethernet IP Settings) are shown in Fig. 20.



Fig. 20: Configuration of IP settings.

Fig. 20 shows the following options to choose from:

- *Obtain an IP address automatically using DHCP* - means setting the IP address automatically through DHCP. After restarting the device it is necessary to search again for the device using the PD8Config application.
- *Use the following IP address* - sets the configuration selected manually by the user. To enter the correct values, please contact the administrator of the network which the converter will be connected to.
- *Enable AutoIP address assignment* - selecting this option will automatically configure the IP address if the address is not available in any other way. For example when the address is set via DHCP and no DHCP server is available.

Click *Apply* button to save the changes and the device will use the new settings after reboot.

6.4.1.2. Network Services Settings

Network services settings are shown in Fig. 21, allow to enable or disable certain network services and configure a TCP/IP port which the services will use for listening.

Service	Protocol	Port	Keep-Alive
<input checked="" type="checkbox"/> Enable Device Discovery (ADDP)	TCP	7027	<input type="checkbox"/> Enable TCP keep-alive
<input checked="" type="checkbox"/> Enable Encrypted RealPort	TCP	570	<input type="checkbox"/> Enable TCP keep-alive
<input checked="" type="checkbox"/> Enable Line Printer Daemon (LPD)	TCP	771	<input checked="" type="checkbox"/> Enable TCP keep-alive
<input checked="" type="checkbox"/> Enable RealPort	TCP	523	<input checked="" type="checkbox"/> Enable TCP keep-alive
<input checked="" type="checkbox"/> Enable Remote Login (rlogin)	TCP	514	<input checked="" type="checkbox"/> Enable TCP keep-alive
<input checked="" type="checkbox"/> Enable Remote Shell (rsh)	UDP	701	<input checked="" type="checkbox"/> Enable TCP keep-alive
<input checked="" type="checkbox"/> Enable Network Management Protocol (SNMP)	TCP	22	<input checked="" type="checkbox"/> Enable TCP keep-alive
<input checked="" type="checkbox"/> Enable Secure Shell Server (SSH)	TCP	23	<input checked="" type="checkbox"/> Enable TCP keep-alive
<input checked="" type="checkbox"/> Enable Telnet Server	TCP	80	
<input checked="" type="checkbox"/> Enable Web Server (HTTP)	TCP	443	
<input checked="" type="checkbox"/> Enable Secure Web Server (HTTPS)			

Fig. 21: Network services settings

Please note, that the standard ports are set which are used in most applications.

After making changes, click *Apply* button to save them. To set the new configuration, restart the device.

6.4.1.3. IP Forwarding Settings

IP Forwarding Settings are used to manage IP forwarding between network interfaces. Static routes can be defined and stored in the routing table.

You can enable or disable IP forwarding by checking or unchecking the box *Enable IP Routing*, as shown in Fig. 22.

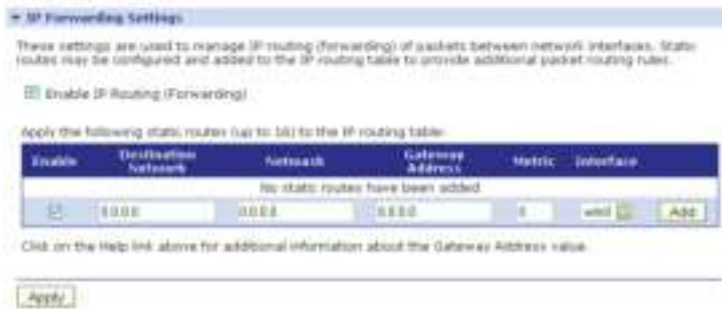

Fig. 22: IP forwarding settings

IP forwarding allows to receive packets from one network interface and transferring them to another one. Using the static routes allows routing IP datagrams to a network that is not in the local network nor is accessible via the default route (gateway). You can configure up to 16 static routes. The value 255.255.255.255 is not allowed in the gateway address field. This value will be ignored for WAN, WiMAX and PPP. Static route configuration may be rejected by the network stack if no gateway has been assigned.

Assigned gateway is used as a static routes gateway if the static routes gateway is configured as 0.0.0.0 for the LAN interface (as shown in Fig. 22).

After making changes, click *Apply* button to save them. To set the new configuration, restart the device.

6.4.1.4. Socket Tunnel Settings

Tunnel settings are shown in Fig. 23. Tunneling is used to connect two network devices, one on the local network via the converter and the other on the remote network. The device can be configured to initiate tunneling.

Tunneling is initiated when the device opens a TCP socket of the converter on the configured port. The converter opens a separate connection to a specific host. When the tunnel is set, the converter acts as a proxy server for data between the network socket and the local network socket, regardless of which device initiated the socket.

After making changes, click *Apply* button to save them. To set the new configuration, restart the device.

Socket Tunnel Settings

Socket Tunnel is used to connect two network devices - one on the TD-4050 Internet Converter's local network and the other on the remote network. Other devices can be configured to initiate the socket tunnel.

Index	Timeout (seconds)	Initiator	Host	Port	Protocol	
No tunnel is now being used.						
1	1000	Initiator: <input type="text"/>		443	SSL	Add
		Destination: <input type="text"/>		443	SSL	

Apply

Fig. 23: Tunnel setting

6.4.1.5. Advanced Network Settings

Advanced settings allow to fine-tuning the network connection and the network interfaces as shown in Fig. 24.

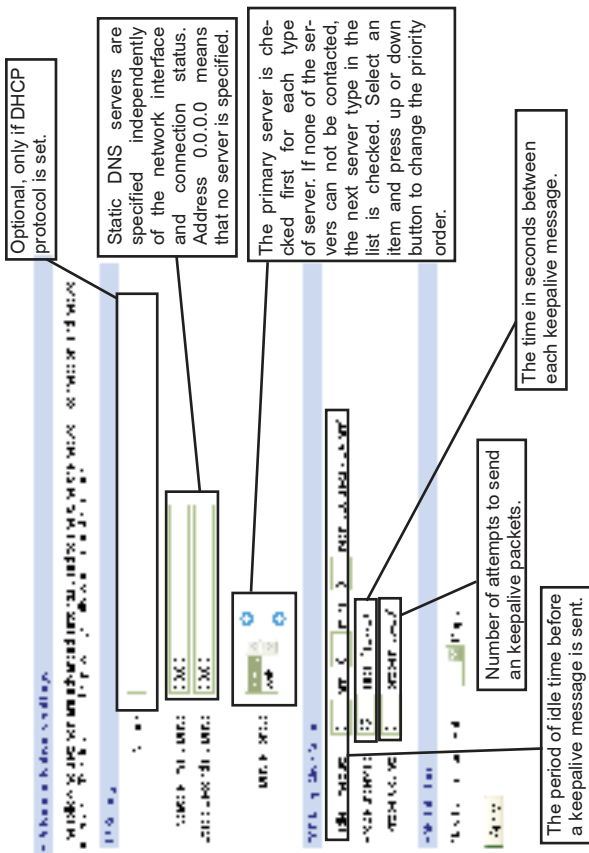

Fig. 24: Advanced network settings

After making changes, click *Apply* button to save them. To set the new configuration, restart the device.

6.4.2 Network Services Settings

PD8 converter allows to configure the serial port settings. The Fig. 25 shows how to access the serial port configuration. First, there is a window with a list of ports; selecting a particular port brings up a window where it is possible to select a port profile. The default profile is access through the terminal - *Local Configuration*.



Fig. 25: Serial port settings.

Selecting a port profile brings up a window shown in Fig. 26 allowing further configuration.



Fig. 26: Port profile settings

Appearance of the window shown in Fig. 26 and the windows with the basic settings (Fig. 27) and the advanced settings (Fig. 28) of a serial port depends on a port profile that has been selected in accordance with Fig. 25.



Fig. 27: Serial port basic settings

Advanced Serial Settings

The following settings are advanced settings used to fine tune the serial port and access to the serial interface. The default settings will typically work in most situations.

Serial Settings

Enable Port Logging

Log Size:

Enable RTS Toggle

Pre-Delay: ms

Post-Delay: ms

Enable RC1 over Serial (OSR)

Fig. 28: Serial port advanced settings

After making changes, click *Apply* button to save them. To set the new configuration, restart the device.

6.4.3. I/O configuration (GPIO)

Converter built-in Wi-Fi module allows to configure five of its free pins. Pin configuration is possible, but not recommended due to the stability of the converter.

6.4.4. Alarms configuration

The PD8 converter can be configured to generate an alarm based on the occurrence of a specific event on input/output (GPIO). Therefore, do not configure alarms.

6.4.5. System configuration

System configuration allows you to configure device identification, date and time as well as SNMP settings.

Configuration of device identification is shown in Fig. 29. You can set the device description, a contact person - usually a network administrator, the location of the device and the device ID that corresponds to the ID used by the iDigi server.



The screenshot shows a web interface for configuring device identity. At the top, there is a blue header bar with the text "Device Identity Settings" and a small left-pointing arrow. Below the header, there are four input fields, each with a label to its left: "Description:", "Contact:", "Location:", and "Device ID:". The "Device ID" field contains the hexadecimal string "00000010-00000000-00403DFF-FF55CD0C". At the bottom of the form, there is a green "Apply" button.

Fig. 29: Device identification

Date and time configuration sets the date and time of the device or sets the UTC offset for the device time system (Fig. 30).

▼ Date and Time Settings

Current system time: Tue Dec 4 12:55:57 8012

Current UTC time: Tue Dec 4 12:55:57 8012

Set Manually set the time

Offset from UTC

Offset from UTC (hh:mm): :

Apply

Specifies the UTC offset for this device. This value can be used to modify the date and time to compensate for time zone and daylight saving time.

Time Source Settings

Index	Type	State	Ranking	Interval	FQDN
1	ntp server	off	10	86400	
2	nntp server	off	10	86400	
3	nntp server	off	10	86400	
4	nntp server	off	10	86400	
5	nntp server	off	10	86400	

Configures the access to five external sources of time which can be used to set and maintain the time for the device.

Time Source #1 - Configuration

Time Source Type: Type the time sources

State:

Sample Ranking: Sample ranking The smaller the number, the greater trust.

Sample Interval:

Host:

Apply **Cancel**

Fig. 30: Date and time configuration in the concentrator.

SNMP configuration allows you to enable or disable the SNMP protocol and its configuration, as shown in Fig. 31.

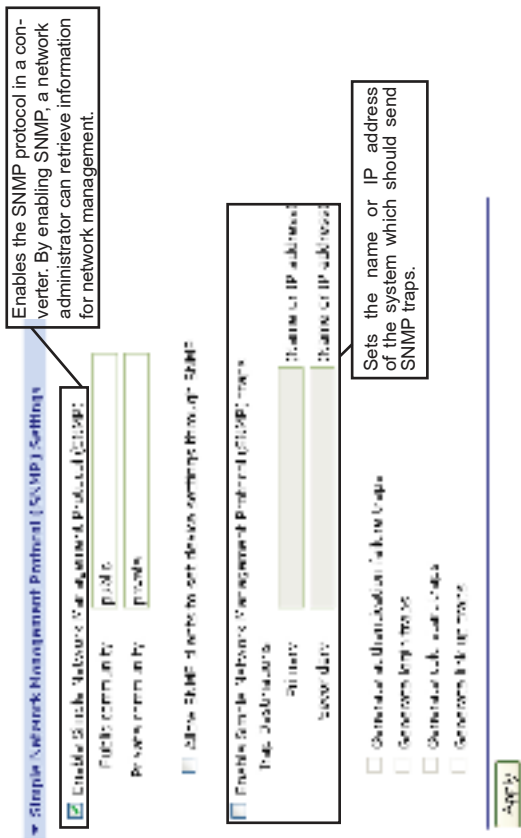

Fig. 31: SNMP configuration

After making changes, click *Apply* button to save them. To set the new configuration, restart the device.

6.4.6. iDigi configuration

IDigi configuration option allows you to configure the connection to the iDigi server. IDigi server allows you to manage devices from different locations.

You must configure the connection to the server as shown in Fig. 32.

The screenshot displays a configuration page for iDigi connection. It is divided into two main sections: "Manual iDigi Connection" and "Server-Initiated iDigi Connection".

Manual iDigi Connection: This section is currently selected. It features a checked checkbox labeled "Enable iDigi connection". Below this, there is a text input field for "iDigi Server Address:". Underneath, there is an unchecked checkbox "Automatically reconnect to iDigi when being disconnected". At the bottom of this section are four radio buttons for "Port number": "0", "1", "2", and "3".

Server-Initiated iDigi Connection: This section is currently unselected. It features an unchecked checkbox labeled "Enable server initiated iDigi connection". Below this, there is an unchecked checkbox "Enable iDigi IP address update when the following server". Underneath, there is a text input field for "iDigi Server Address:". At the bottom of this section are four radio buttons for "Port number": "0", "1", "2", and "3".

At the bottom left of the configuration area, there is a button labeled "Apply".

Fig. 32: Connection configuration

Advanced settings shown in Fig. 33 allow to tune the connection between the converter and the iDigi server.

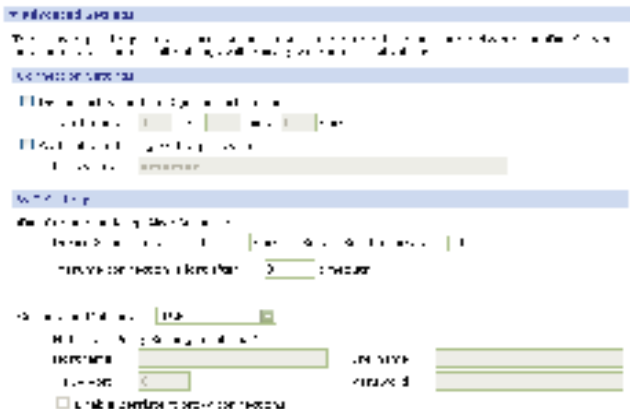

Fig. 33: Advanced settings.

After making changes, click *Apply* button to save them. To set the new configuration, restart the device.

6.4.7. Users

User configuration allows you to add new users (Fig. 34) and configure the settings for each user. The PD8 converter allows you to create one additional user, and change the settings of a default user. User settings are changed and the default account is restored after restoring the default parameters. Clicking on the username brings up a window where you can change the settings.

Users Configuration

▼ Users

Full Access

Configure Users

User Name	Action
root	

Add New User

User Name:

New Password:

Confirm Password:

Fig. 34: Users configuration

User configuration allows you to change a username, password, the access rights - Fig. 35 and user permissions.



Fig. 35: User access rights

User permissions can be set separately for each setting to read, write and no access. Permissions can be set to access the configuration and administration.

After making changes, click *Apply* button to save them. To set the new configuration, restart the device.

6.5. Applications

The converter allows you to configure two applications listed below.

6.5.1. RealPort

The PD8 converter allows you to connect through RealPort application. RealPort configuration is shown in Fig. 36.

RealPort Configuration

RealPort Settings

- Enable keep-alives
- Enable exclusive mode
- Enable RealPort Authentication

Shared Secret:

Device Initiated RealPort Settings

Index	Host or IP	Port	Retry time
No Device Initiated RealPort Connections have been configured			

Device Initiated RealPort #1 - Configuration

Host or IP Address:

UDP Port:

Retry Time:

Fig. 36: RealPort application settings

After making changes, click *Apply* button to save them. To set the new configuration, restart the device.

6.6. Management

Management tab allows you to manage PD8 converter connections.

6.6.1. Serial port management

The converter allows you to manage the serial ports through the website, you can view ports, as shown in Fig. 37. There is information of the type: description, profile, connected from, connected with, protocol and session on next action tab.

The figure displays two screenshots from a web interface. The top screenshot, titled "Serial Port Management", shows a table with the following columns: Port, Description, Profile, and Manage. The first row of data shows "Port 1", "Name", "Profile", and a link labeled "Connections" which is circled. A callout line connects this link to a second screenshot below. The second screenshot, titled "Port Connections Management - Port 1", shows a table with columns: Action, Connected From, Connected To, Protocol, and Sessions. Below the table, it states "No active connections." and includes two buttons: "Refresh" and "Disconnect".

Fig. 37: Serial port management

6.6.2. Connection management

Connections Management tab allows to view the connections of the converter and disconnect the selected connections, as shown in Fig. 38.



The screenshot shows a web interface titled "Connections Management". Below the title is a section labeled "Active System Connections". It contains a table with five columns: "Action", "Connected From", "Connected To", "Protocol", and "Sessions". There are four rows of data, each with a checkbox in the "Action" column. Below the table are two buttons: "Refresh" and "Disconnect".

Action	Connected From	Connected To	Protocol	Sessions
<input type="checkbox"/>		realport server	realport	0
<input type="checkbox"/>		realport server	realport	0
<input type="checkbox"/>	192.168.1.5	webui	http	0
<input type="checkbox"/>		serial 1	realport	0

Fig. 38: Connections management

6.7. Administration

Administration tab allows you to administrate the device. You can upload files to the converter, create and restore a backup configuration, update software, restore the default settings, check the system information, restart the device.

6.7.1. File management

The PD8 Converter allows you to load settings file and delete them in the *File Management* tab, as shown in Fig. 39.



Fig.39: File management.

6.7.2. Configuration Back-up/Restoring Configuration

The converter configuration can be saved to a file and can be restored from the file in the Backup/Restore tab, as shown in Fig. 40.



Fig. 40: Configuration Back-up/Restoring Configuration.

6.7.3. Firmware update

Check the help page to verify if the software needs to be updated before updating it. You must first update a POST file and then update the software. Firmware update is shown in Fig.41.



Fig.41: Software update

6.7.4. Restoring default parameters

Restoring the default parameters will erase all previous settings. You can preserve the network settings, security settings, keys and certificates, as shown in Fig.42.



Fig. 42: Restoring default parameters.

6.7.5. System Information

Device Information tab contains the most important information about the device.

6.7.6. Rebooting

To restart the device, select Reboot tab and then click the *Reboot* button as shown in Fig. 43.



Fig. 43: Rebooting

The webpage will be reloaded to the login webpage after you restart the converter.

6.8. Logging a user out

Clicking *Logout* will log out the user. To go back to the login page, proceed as shown in Fig. 44.

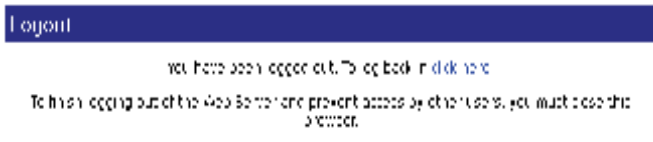

Fig. 44: Logging out a user

7. OPERATING MODE WITH REALPORT SERVICE

The PD8 converter includes the RealPort network service licensed by Digi Inc. that enables communication via Ethernet with PCs running Windows OS.

Installation of RealPort driver for Windows adds another so-called virtual COM port to the list of ports available on the computer. This port is virtual hardware - thanks to software emulation of a typical serial interface.

Use of the additional virtual COM ports can replace serial communication with Ethernet communication.

PD8 converter design allows only one network connection via RealPort service at a time. It means that only one PC with any IP address can communicate with the converter via a virtual serial port. The service is currently not available for other computers and therefore, there is an error message on their screens.



7.1. RealPort service driver file information

RealPort service driver files are available on the enclosed CD. There are versions for two different Windows systems in two directories:

- version for MS Windows 98 and MS Windows Me,
- version for MS Windows 2000, MS Windows XP,
- version for MS Windows Vista and MS Windows 7.

You need to install the appropriate version of the RealPort driver depending on the system version running on a computer.

Details of service driver installation for Windows are available on the website of each PD8 converter.

7.2. Example of driver installation in Windows XP

To install the RealPort service driver in the popular operating system such as Microsoft Windows XP, please follow these steps (installation on other Windows versions differs insignificantly):

1. Click *Start* button, indicate the command *Settings*, click the command *Control Panel*.
2. Double-click the *Add/Remove Hardware* icon to open the Add Hardware Wizard. Click *Next* and click again *Next*.
NOTE: The Add/Remove Hardware Wizard is searching for new devices.
3. If prompted *Is the hardware connected?*, click *Yes, I have already connected the hardware.* and click *Next*.
4. Select from the list *Add a new hardware device* and click *Next*.
5. Select *Install the hardware that I manually select from a list (Advanced)* and click *Next*.
6. Select from the list *Multi-port serial adapters* and click *Next*.
7. Click *Have disk... .*
8. Enter the path to the RealPort file and click *OK* or *Browse* to select the files.
9. Select the file *digirip.inf*, click *Open* and then click *OK*.
10. Select on the list *Model installed device Standard RealPort Device (or Digi Connect WI-ME in case of Windows 98/ME)*, click

- Next* and click again *Next*.
11. In the dialog box *Add Digi Hardware Wizard* enter PD8 converter IP address and leave unchanged the port number (771). Click *Next*.
 12. In case of Windows 98/ME, in the field Name enter a custom name (e.g. Test) for the PD8 converter for easy identification during the operation. Leave the number of PD8 converter serial ports unchanged (1).
 13. Click *Next* and then *Finish*.
 14. Confirm the next message to complete the RealPort installation.

7.3. RealPort driver configuration in Windows XP

The RealPort driver must also be configured using the Windows Device Manager after a successful installation by the previous section. To do this, follow these steps:

1. Click *Start* button, indicate the command *Settings*, click the command *Control Panel*.
2. Double-click the *System* icon to open the *System Properties* window. Select the *System* tab and click the *Device Manager* button.
3. After the *Device Manager* window shows up (Fig. 45) in the tree of available devices, expand the branch *Ports (COM and LPT)*. You can see in this example that there are three serial ports COM1, COM2, LPT1 available. Once RealPort driver is installed, there is port available in a system - virtual - COM2 - labeled as PD8 Converter Port (Fig. 45).

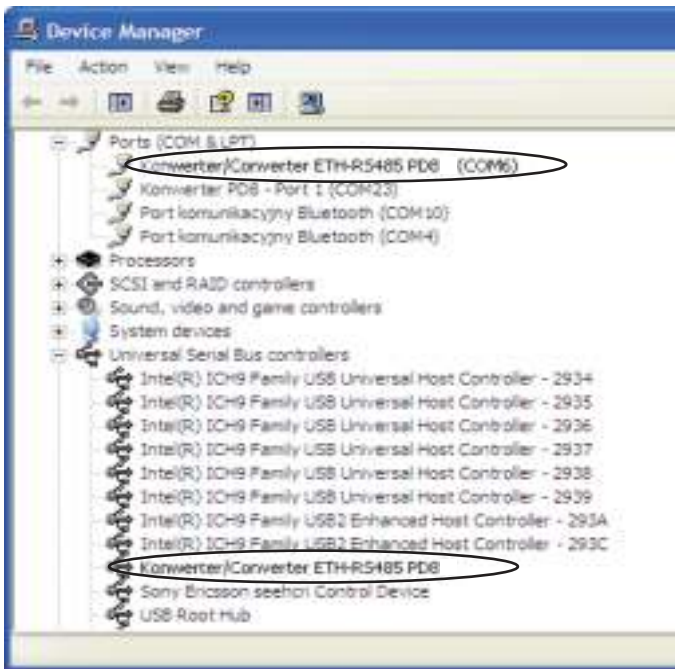

Fig. 45: Sample list of devices

4. Expand the branch *Multi-port serial adapters* (Fig. 45), which shows the PD8 converter installed (in Windows 98 it appears as a „PD8 Converter”).

8. SERIAL BRIDGE MODE WITH THE UDP PROTOCOL

The converter operation in the serial bridge mode enables an expansion of the RS-485 bus by successive segments using additional PD8 converters and Ethernet networks. Bridge configuration in a local network allows you to create up to 65 access points between the network RS-485 and Ethernet Wi-Fi using a 65 PD8 converters.

Serial bridge service configuration of a given converter can be divided into four stages:

1. Determination of serial link transmission parameters.
2. Enabling client service, specifying the IP addresses and ports of servers for other converters, which retransmit serial data frames.
3. Defining frames caching of a serial transmission protocol.
4. Enabling a service server on the specified IP port of a configured converter.

Setting the serial bridge operation mode is done by using the configuration application on the webpage of the PD8, which is called by the user via a web browser installed on user's PC.

8.1. Determination of serial link transmission parameters

Select device options from the website navigation menu *Serial port* to display the serial port settings (see section 6.4.2. *Serial port settings*). Please make sure to set the same type of transmission word for each connected converter when setting transmission parameters. The baud rate can be different between segments, but consistent with settings of the devices connected to the RS-485 segment.

8.2. Configuration of client service operation

A user can configure a bridge client by selecting on option *Serial port* from the website navigation menu and setting a port profile to *UDP Socket* according to Fig. 46.

File
 View
 Applications
 Settings
 Help

Serial Port Configuration			
Port	Direction	Arts	Serial Port Settings
COM1	None	None	9600, 8N1

Select a profile to use:

Select a profile to use for this serial port. The profile defines the serial port's name and settings.

- Default
- Custom (New profile)
- Custom (Import)
- Custom (Save)
- Custom (Delete)

The Custom (Save) profile is selected. The Custom (Save) profile is selected. The Custom (Save) profile is selected.

Fig. 46: Serial port profile setting

When a port profile has been already selected, a window will appear as shown in Fig. 47. Select then the highlighted option Change profile which will bring up a window shown in Fig. 46.



Fig. 47: Port profile change

Enable first the UDP client option to begin the configuration process, as shown in Fig. 64. Complete the fields of converters' IP and ports addresses to retransmit frames the serial data according to following rules:

- In case of connection in the relation 1 to 1, set in each converter the address and IP port of the remaining converter being in relation.
- In case of connection in the relation 1 to several, set in each slave converter the address and IP port of the master converter. However, in the master converter set all (up to 64) addresses and ports of the slave converters remaining in relation.

The default IP port number for the serial bridge service is 2101. In case of a conflict with another network service using the same port in the given local network - it is possible to change its number - both for the bridge service server and the client.

Serial Port Configuration

Port Profile Settings

Current Port Profile: **UDP Sockets** [Change Profile...](#)

The UDP Sockets Profile allows a serial device to communicate using UDP.

UDP Server Settings

The serial device receives data from one or more devices or systems on the network using UDP sockets.

Enable UDP access using UDP Port:

UDP Client Settings

Automatically send serial data to one or more devices or systems on the network using UDP sockets.

Automatically send serial data

By default, serial data is returned to the last client which sent any data. To override this default, enter a list of destinations and a unicast copy of all serial data is sent to each:

Description	Send To	UDP Port	
No destinations currently configured			
<input type="text" value="Controls"/>	<input type="text" value="192.168.0.200"/>	<input type="text" value="2101"/>	<input type="button" value="Add"/>

Send data under any of the following conditions:

Send when data is present on the serial line

Match string:

Strip string before sending

Send after following number of idle milliseconds

ms

Force send after the following number of bytes (limits UDP packet size)

bytes

Fig. 48: Settings for UDP client

After making changes, click *Apply* button to save them. To set the new configuration, restart the device.

9. OPERATING MODE WITH TCP SOCKET SERVICE

Operation with TCP Socket service mode is very similar to the mode with Real Port service. The only difference is the way of communication with the PD8 device, which in this case, a direct TCP/IP connection is used and providing PD8 IP address and a port number.

TCP Socket service configuration of the given converter can be divided into three stages:

1. Determination of serial link transmission parameters.
2. Defining frames caching of a serial transmission protocol.
3. Enabling a service server on the specified IP port of a configured converter.

Setting the serial bridge operation mode is done by using the configuration application on the webpage of the PD8, which is called by the user via a web browser installed on user's PC.

Enabling TCP Socket mode is similar to the UDP Socket, select from the left side of a website navigation menu an option *Serial Port* and set a port profile to *TCP Socket* according to Fig. 49.

Serial Port Configuration

Part	Description	Profile	Serial Configuration
Part 1	Name	Local Configuration	RS232 CRL

Select Part Profile...

Profile allows you to easily configure serial ports by only displaying those items that are relevant to the chosen profile.

Select the profile on the left that matches your configuration.

 Keyboard

The Keyboard Profile allows you to configure COM port for keyboard. [More...](#)

 Device Management

The Device Management Profile allows you to configure serial ports for device management over a network connection. [More...](#)

 TCP Sockets

The TCP Sockets Profile allows a serial device to communicate over a TCP connection. [More...](#)

 USB Winbox

The USB Winbox Profile allows a serial device to communicate over a USB connection. [More...](#)

 Serial Bridge

The Serial Bridge Profile allows two serial ports to communicate over a network as if they were connected with a serial cable. [More...](#)

Fig. 49: TCP Socket mode setting

Enable first the TCP client option to begin the configuration process, as shown in Fig. 50.

Serial Port Configuration

Port Profile Settings

Current Port Profile: **TCP Sockets** [Change Profile...](#)
 The TCP Sockets Profile allows a serial device to connect to a remote TCP network.

TCP Device Settings

Communicate to the serial device using the following TCP ports on the network:

<input checked="" type="checkbox"/> Enable TTY access using TCP Port	2321	<input type="checkbox"/> Enable TCP keep-alive
<input checked="" type="checkbox"/> Enable Pure TCP access using TCP Port	2321	<input type="checkbox"/> Enable TCP keep-alive
<input checked="" type="checkbox"/> Enable Secure Shell (SSH) access using TCP Port	2321	<input type="checkbox"/> Enable TCP keep-alive
<input checked="" type="checkbox"/> Enable Secure Socket access using TCP Port	2321	<input type="checkbox"/> Enable TCP keep-alive

TCP Client Settings

Automatically establish bi-directional TCP connections between the serial device and a server or other hardware device.

Automatically establish TCP connections

Establish connection to server using one of the following conditions:

- Detect connect and initiate a connection
- Connect when data is present on the serial line
 Hex string:
 String ending before sending
- Connect when DCD (Data Carrier Detect) line goes high
- Connect when CSR (Data Set Ready) line goes high

Establish connection to the following network device:

Server (network IP):
 Service:
 TCP Port:
 Enable TCP keep-alive

Fig. 50: Settings for TCP client

After making changes, click *Apply* button to save them. To set the new configuration, restart the device.

10. Technical data

Communication interfaces

Interface	RS -232	RS – 485	USB	Ethernet
Function	Communication with a PC and HMI panels	Communication with Slave type devices	Device configuration	Communication and configuration of the device
Baud rate	300, 600, 1200, 2400, 4800, 9600, 19200, 38400, 57600, 115200 bit/s			10/100 Mbit/s
Transmission protocol	Modbus RTU		RCI (Remote Command Interface)	HTTP, FTP, ICMP, DHCP, ARP, Digi RealPort [®]
Comments	Max. długość przewodu zależna od prędkości transmisji		Max. długość przewodu do 2 m	

External features

Weight	< 0.25 kg
Dimensions	45x120x100 mm
Protection grade (acc. to EN 60529)	From housing side: IP30 From terminals side: IP20
Fixing	Assembly on a 35 mm rail

Rated operating conditions

Supply voltage	20... <u>24</u> ...50 V a.c./d.c. or 85... <u>230</u> ...253 V a.c./d.c. 40... <u>50/60</u> ...440 Hz	power consumption: < 4 VA
Ambient temperature	operating: 0... <u>23</u> ...55°C	storage: -20...70°C
Relative humidity	< 85%	Condensation not permissible
Operating position:	any	
External magnetic field:	<400 A/m	

Safety and compatibility requirements

Electromagnetic compatibility	Noise immunity	Acc. to EN 61000-6-2
	Noise emission	Acc. to EN 61000-6-4
Safety requirements	Installation category III	Acc. to EN 61010-1
	Pollution grade 2	
Maximum phase-to-earth operating voltage	For supply circuit: 300 V	
	For remaining circuits: 50 V	

11. ORDERING CODE PD8

PD8 -	X	XX	X	X
Supply voltage:				
85...253 V a.c./d.c.	1			
20...50 V a.c./d.c.	2			
Version:				
standard		00		
custom-made*		XX		
Language:				
Polish			P	
English			E	
other*			X	
Acceptance tests:				
without extra quality requirements				0
with extra quality inspection certificate				1
acc. to customer's request*				X

* only after agreeing with the manufacturer

Ordering example:

The code: **PD8 - 1 00 E 1** means:

PD8 - converter of PD8 type,

1 - supply voltage 85...253 V a.c./d.c.,

00 - standard version,

E - English language version,

1 - with extra quality inspection certificate.

12. MAINTENANCE AND SERVICE

The PD8 converter does not require periodical maintenance. In the case of damage the converter must be sent to the Manufacturer's Service for repair.



Sifam Tinsley Instrumentation Inc

3105, Creekside Village Drive, Suite 801

Kennesaw GA 30144

email – psk@sifamtinsley.com

Phone - +1 404 736 4903