



PANEL DIGITAL RECORDER
N30B



USER'S MANUAL



CONTENTS

1 APPLICATION AND RECORDER DESIGN	5
2 RECORDER SET	7
3 BASIC REQUIREMENTS, OPERATIONAL SAFETY	8
4 INSTALLATION.....	9
4.1 Lead-outs of Signals	11
5 SERVICE.....	13
5.1 Display Description	13
5.2 Messages after Switching the Supply on	14
5.3 Functions of Push-buttons	15
5.4 Programming.....	19
5.4.1 Way to Change the Selected Parameter Value	22
5.4.2 Changing Floating-Point Values	22
5.4.3 Setting of Archived Registers	22
5.4.4 Characteristic of Programmed Parameters	24
5.4.5 Individual Characteristic	37
5.4.6 Alarm Types.....	39
5.4.7 Display Format	41
5.5 Recorder Configuration to Work in the Master Mode	42
5.6 Recorder Configuration to Work in the Slave Mode	45
5.7 Manufacturer's Parameters	47
6 INTERNAL ARCHIVE	50
6.1 Memory Structure.....	50
6.2 Record Construction	51
6.3 Archive Data Downloading.....	52

7 MEMORY CARD	55
7.1 Catalogue Structure	56
7.2 Construction of Archive Files.....	57
8 INTERFACE RS-485	59
8.1 Connection Way of the Serial Interface.....	59
8.2 Description of the MODBUS Protocol Implementation.....	60
8.3 Description of Applied Functions.....	61
8.4 Register Map.....	61
8.5 Registers for Write and Readout.....	64
8.6 Registers Only for Readout.....	102
8.7 Registers of Values for Readout and Write.	106
9 ERROR CODES	109
10 TECHNICAL DATA	110
11 ORDER CODES	113
12 MAINTENANCE AND GUARANTEE	115

1. APPLICATION AND RECORDER DESIGN

The N30B recorder is a panel programmable digital instrument, destined to display and archive digital values from connected devices through the RS-485 interface. Additionally, the recorder enables to show the actual time. The readout field is composed of a LED display which allows the exposition of results in colours: red, green and orange. The measured readout values can be freely converted by means of the 21-point individual characteristic.

Features of the N30B recorder:

- Display colour programmed individually in three intervals.
- Programmable thresholds of displayed overflows.
- Two relay alarms with NOC contacts operating in 6 modes.
- Two relay alarms with switching over contact operating in 6 modes (option).
- Signalling of the measuring range overflow.
- Automatic setting of the decimal point.
- Programming of alarm and analog outputs with reaction on the selected input quantity (any register read out or recorded or real time lock).
- Real time lock with the supported supply function of the clock in case of a recorder supply decay.
- Automatic change of time from the summer to winter time and inversely (this function can be disabled).
- Programmed averaging time – function of walking window with the averaging time up to 1 hour.
- Monitoring of set parameters.
- Locking of introduced parameters by means of a password.
- Recounting of measured value on the base of a 21-point individual characteristic.

- Data archiving in data internal memory with a capacity of 308000 records.
- Any configuration of the archived data – any values with established time intervals can be archived.
- Conditional archiving – archiving of alarm states.
- Service of MMC / SD cards with capacity up to 4GB – - serviced system of FAT and FAT32 files.
- Automatic copying of the internal archive on the memory card.
- Signalling of the transmission state and the memory card state on the recorder display.
- Service of the interface with MODBUS protocol in RTU mode (implemented Master and Slave mode).
- Data readout of 10 devices with 10 registers in each device.
- Monitoring of readout/recorded register values directly accessible from the recorder keyboard.
- Retransmission of read out/recorded quantities into a standard, programmable current or voltage signal (option).
- Backlight of any measuring unit as per order.
- Signalling of alarm operation – The alarm supply causes the backlight of the output number.
- Galvanic separation between terminals: alarming, supplying, analog, RS-485 interfaces (port 1 and port 2).
- Protection grade from frontal face: IP65, overall recorder dimensions: 96 x 48 x 93 mm (with terminals). The recorder casing is made of plastics.



Fig. 1. View of the N30B recorder

2. RECORDER SET

The set is composed of:

- N30B recorder 1 pc
- user's manual 1 pc
- Clamps to fix in the panel 4 pcs
- Seal 1 pc

When unpacking the recorder, please check whether the type and version code on the data plate correspond to the order.

3. BASIC REQUIREMENTS, OPERATIONAL SAFETY

In the safety service scope, the N30B recorder meets the requirements of the EN 61010-1 standard.

Symbols located in this manual are:



Especially important, one must get acquainted before connecting the recorder. Disregard of notices marked by this symbol can cause the recorder damage.



One must take into consideration when the recorder operates inconsistently with expectations.



Observations concerning the operational safety:

- All operations concerning transport, installation, and commissioning as well as maintenance, must be carried out by qualified, skilled personnel, and national regulations for the prevention of accidents must be observed.
- The programming of N30B recorder parameters must be carried out after disconnecting measuring circuits.
- Before switching the recorder on, one must check the correctness of connections.
- The recorder is destined to be installed and exploited in electromagnetic industrial environment conditions.

- Non-authorized removal of the housing, inappropriate use, incorrect installation or operation, creates the risk of injury to personnel or recorder damage.
- For more detailed information, please study the User's Manual.
- When connecting the supply, one must remember that a switch or a circuit-breaker should be installed in the building. This switch should be located near the device, easy accessible by the operator, and suitably marked as an element switching the recorder off.

4. INSTALLATION

The recorder has separable strips with screw terminals, which enable the connection of external wires of 1.5 mm² cross-sections for the RS-485 object interface and 2.5 mm² for other signals.

One must prepare a hole of 92^{+0.6} x 45^{+0.6} mm in the panel, which the thickness should not exceed 6 mm.

The recorder is adapted to be mounted in a panel. The recorder must be introduced from the panel front with disconnected supply voltage. Before the insertion into the panel, one must check the correct placement of the seal. After the insertion into the hole, fix the recorder by means of clamps (fig.2).

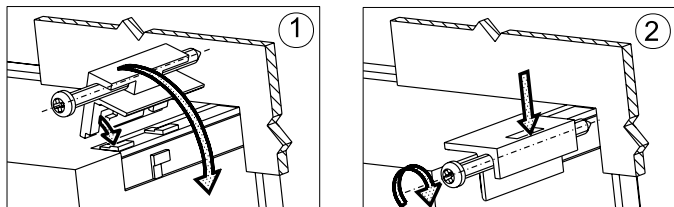

Fig. 2. Recorder fixing.

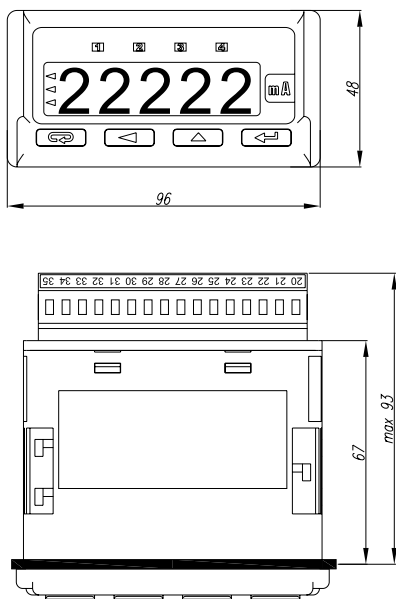

Fig. 3. Overall dimensions.

4.1 Lead-outs of Signals

Signals led out on the recorder connectors are presented on the fig. 4. Circuits of successive groups of signals are separated between them. RS-485 interfaces are separated between them and separated from remaining connectors.

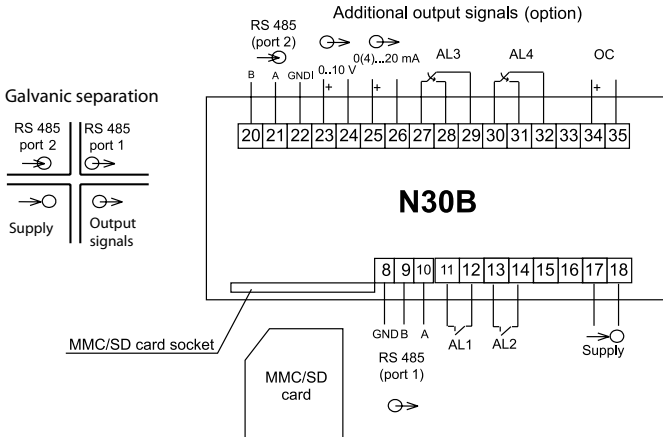

Fig. 4. Description of signals on connection strips.

The N30B recorder has one or two led out RS-485 interface operating in MODBUS RTU standard. In case of a recorder version equipped with a plate with additional signals, the interface of the port 1 always operates in master mode, however the interface on the port 2 always operates in slave mode. For versions without additional signals (without the upper plate) the interface of the port 1

works depending on the *RETYPE* parameter setting in the recorder menu as master or slave (table 1). The OC output is used for signalling the transmission error with devices added on during the master mode operation.

Notice !: the memory card must be inserted into the recorder with contacts on the upper side. Before the card insertion, one must acquaint with the memory card description (Chapter 7 of the user's manual)

Notice !: The connection of RS-485 interface signals must be made by means of a wire composed of twisted pairs placed in a braided screen. During the assembly, one must take into consideration that A and B lines constitute one pair of wires twisted together. The screen must be connected to the terminal PE in the nearer proximity of the N30B recorder.

5. SERVICE

5.1 Display Description

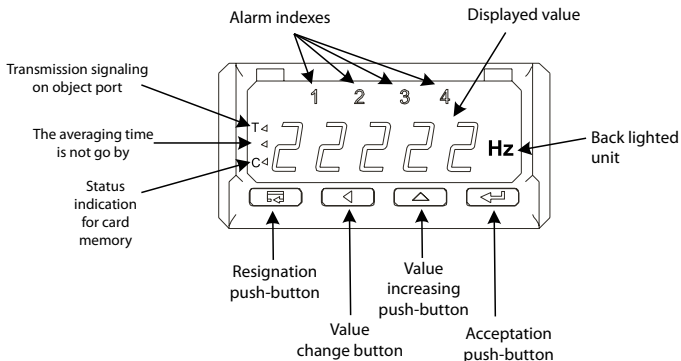

Fig. 5. Description of the recorder frontal plate.

Special symbols placed on the recorder display mean:

- **T** – transmission symbol on the object port. The symbol is flickering during broadcasting (red colour) or receiving (green colour) data by the recorder.
- **C** – the symbol defines the state of the memory card. In case when the symbol is blank, that means there is no card in the recorder or the card has been disassembled. The symbol in green colour signal the record of data in the memory card. The lighting of the symbol in red colour means an error in the card initiating – the card is damaged, not formatted or the type of card is not serviced. The lighting of symbol in orange colour means that a protection against recording is enabled on the card.

- the averaging time is not go by – the index is lighted if the value displayed on the display is not averaged in the full **Cnt** period. Such an event takes place after connecting the supply or in case of a transmission error with the co-operating device, which the value has to be averaged. After the error decay, the averaging period begins again.

5.2 Messages after Switching the Supply on

After switching the supply on, the recorder displays its name $\alpha\beta\gamma-b$ and next, the software version in the shape „x.xx” – where x.xx is the number of the current software version or the number of a custom-made version. Next, the recorder transits to the normal operation and begins to display values according to the set parameter $r-d, SP$ (table 1). When displaying values, the recorder sets automatically the comma position, and at the same time, the format (number of places after the comma) can be limited by the user.

5.3 Functions of Push-buttons

 – Acceptation push-button:

- ⇒ entry in programming mode (press and hold down ca 3 seconds),
- ⇒ moving through the menu – choice of level,
- ⇒ entry in the mode changing the parameter value,
- ⇒ acceptance of the changed parameter value,
- ⇒ stop the displayed value – when holding down the push-button, the result on the display is not updated.

 – push-button increasing the value:



- ⇒ display of the maximal value, The pressure of the push-button causes the display of the maximal value during ca 3 seconds. ,
- ⇒ entry in the level of the parameter group,
- ⇒ moving through the selected level,
- ⇒ change of the selected parameter value – increasing the value.

 – push-button changing the digit:

- ⇒ display of minimal value, The pressure of the push-button causes the display of the minimal value during ca 3 seconds.
- ⇒ entry in the level of parameter group,
- ⇒ moving through the selected level,
- ⇒ change of the selected parameter value – shift on the next digit.



 – resignation push-button:

- ⇒ entry in the menu monitoring the recorder parameters (by holding down ca 3 seconds),
- ⇒ exit from the menu monitoring recorder parameters,
- ⇒ resignation of the parameter change,
- ⇒ absolute exit from the programming mode.

The pressure of the  and  push-button combination and holding them down ca 3 seconds causes the erasing of alarm signalling. This operation acts exclusively when the support function is switched on.

The pressure of the   push-button combination causes the erasing of the minimal value.





The pressure of the   push-button combination causes the erasing of the maximal value.

The pressure of the   push-button combination causes the entry into the monitoring mode of read out value registers. The register name (orange colour) and the value in the register (green colour) appear alternately on the display. The selection of the currently displayed register is carried out by means of the increasing or decreasing push-button. The name of the displayed register is composed of two values. The first value, preceded by the letter **d**, means the device number which data have been read out from. The second value preceded by the letter **r**, means the register number read out from the device.

The pressure of the   push-button

combination causes the data transfer from internal memory onto a card. Till the time to remove, the inscription $5Y\pi\epsilon h$ twinkles interchangeably with the percentage quantity of copied data on the display. After removing the card from the recorder the inscription disappears automatically and the recorder returns to the normal operating mode.

The pressure and holding down the  push-button during ca 3 seconds causes the entry in the programming matrix. The programming matrix can be protected by a safety code. The programming matrix can be protected by a safety code.

The pressure and holding down the  push-button during ca 3 seconds causes the entry to the monitoring menu of recorder parameters. One must move through the monitoring menu by means of  and  push-buttons. In this menu, all programmable recorder parameters are only available for readout. In this mode, the menu $5E_r$ is not available. The exit from the monitoring menu is carried out by means of the  push-button. In the monitoring menu, parameter symbols are displayed alternately with their values.

The service algorithm of the recorder is presented on the fig. 6.

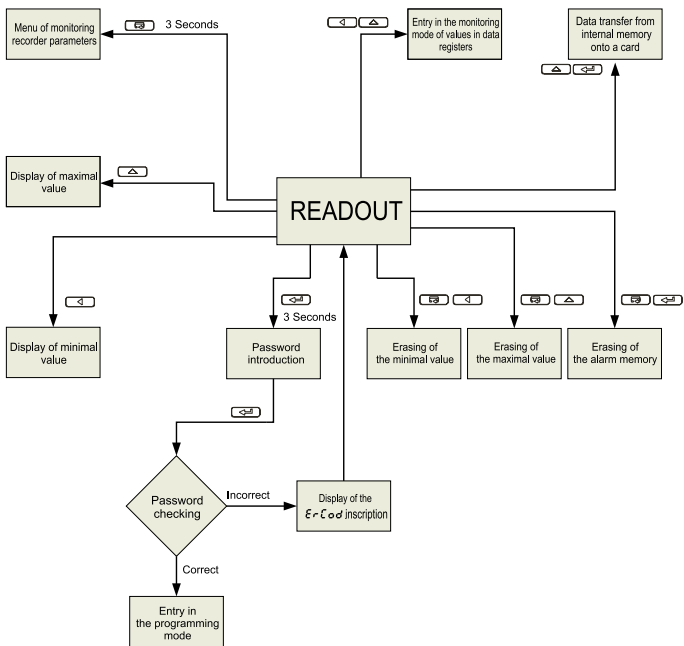









Fig. 6. Service algorithm of the N30B recorder.

5.4 Programming



The pressure of the  push-button and holding it down through ca 3 seconds causes the entry in the programming matrix. If the entry is protected by a password, then the safety code symbol $5E\bar{C}$ is displayed alternately with the set value **0**. The write of the correct code causes the entry in the matrix, the write of an incorrect code causes the display of the $E_r\bar{C}od$ symbol. The matrix of transitions into the programming mode is presented on the fig. 6. The selection of the level is made by means of the  button, however the entry and moving through the parameters of the chosen level is carried out by means of  and  push-buttons. Parameter symbols are displayed alternately with their current values. In order to change the value of the selected parameter, one must use the  push-button. To resign from the change, one must use the  push-button. In order to exit from the selected level, one must choose the ----- symbol and press the  push-button. To exit from the programming matrix, one must press the E_{nd} appears for ca 3 seconds and the recorder transits to the display of the set parameter. In case of leaving the recorder in the parameter programming mode, the automatic abandon of the programming mode (parameter, and next the menu) follows after 30 seconds and the transition to display values of the set parameter.



Item 1	<i>INPUt</i> Parameters of main input	<i>rd,ISP</i> Displayed register	<i>Ent</i> Measurement time	<i>ARYPE</i> Archiving type	----
2	<i>Ind</i> Parameters of individual characteristic	<i>IndEP</i> Number of points of individual characteristic.	<i>H1</i> First point of the indiv. characteristic. Point x.	<i>Y1</i> First point of the indiv. characteristic. Point y.	...
3	<i>dISP</i> Display parameters	<i>dP</i> Minimum decimal point	<i>colLo</i> Lower colour	<i>colbE</i> Middle colour	<i>colUP</i> Upper colour
4	<i>ALr1</i> Alarm 1	<i>P_R1</i> Type of input quantity of alarm 1	<i>PrL_1</i> Lower threshold	<i>PrH_1</i> Upper threshold	<i>tyP_1</i> Alarm type
...
7	<i>ALr4</i> Alarm 4	<i>P_R4</i> Type of input quantity of alarm 4	<i>PrL_4</i> Lower threshold	<i>PrH_4</i> Upper threshold	<i>tyP_4</i> Alarm type
8	<i>OUT</i> Outputs	<i>P_An</i> Type of quantity for analog output	<i>An_Lo</i> Lower threshold of analog output	<i>An_Hi</i> Upper threshold of analog output	<i>tyP_A</i> Kind of output (volt./current)
9	<i>SER</i> Service	<i>SEt</i> Write standard parameters	<i>SECUr</i> Introduce the password	<i>HoUr</i> Set the time	<i>yERr</i> Set the date -year
11	<i>dEUD</i>	<i>Addr0</i> Address of the device No 0	<i>r_bA0</i> Basic address	<i>r_no0</i> Number of readout registers	<i>rtyP0</i> Type of readout registers
...
20	<i>dEUG</i>	<i>Addr9</i> Address of the device No 9	<i>r_bA9</i> Basic address	<i>r_no9</i> Number of readout registers	<i>rtyP9</i> Type of readout registers

<i>H2 I</i> Last point of the characteristic	<i>Y2 I</i> Last point of the characteristic.	----				
<i>colLo</i> Lower threshold of colour change	<i>colHi</i> Upper threshold of colour change	<i>ovrLo</i> Lower overflow	<i>ovrHi</i> Upper overflow	----		
<i>dLy_1</i> Alarm delay	<i>LEd_1</i> Signalling support	----				
...	...	----				
<i>dLy_4</i> Alarm delay	<i>LEd_4</i> Signalling support	----				
<i>bAud</i> Baud rate	<i>Prot</i> Kind of frame	<i>Addr</i> Device address	<i>bAud I</i> Baud rate on the object port	<i>Prot I</i> Kind of frame on the object port	<i>t_out</i> Waiting time for the response	---
<i>dAtE</i> Set the date – month and day	<i>Cl</i> Change the time –summer/winter	<i>Unit</i> Backlight the unit	<i>tEst</i> Display test	<i>RI U</i> Degree of memory occupancy	<i>dEL_A</i> Erase the archive	---
<i>rFr90</i> Scanning frequency	<i>AR-E60</i> Selection of archived registers	<i>ARFr90</i> Archiving frequency	<i>ARyP0</i> Kind of archiving	<i>dPrL0</i> Lower threshold of conditional archiving	<i>dPrH0</i> Upper threshold of conditional archiving	---
...	---
<i>rFr99</i> Scanning frequency	<i>AR-E69</i> Selection of archived registers	<i>ARFr99</i> Archiving frequency	<i>ARyP9</i> Kind of archiving	<i>dPrL9</i> Lower threshold of conditional archiving	<i>dPrH9</i> Upper threshold of conditional archiving	---

Fig. 7. Programming matrix.



5.4.1 Way to Change the Selected Parameter Value

In order to increase the value of the selected parameter, one must press the  push-button. A single pressure of the push-button, causes the increase of the value of 1. The increase of value when displaying the digit 9 causes the setting of 0 on this digit. The change of the digit follows after pressing the  push-button.

In order to accept the set up parameter, one must hold down the  button. Then, the write of the parameter and the display of its symbol follows alternately with the new value. The pressure of the  push-button during the change of the parameter value will cause the resignation of the write.

5.4.2 Changing Floating-Point Values

The change is carried out in two stages (the transition to the next stage follows after pressing the  push-button):

- 1) setting the value from the range -19999...99999, similarly as for integral values;
- 2) setting of the decimal point position (00000., 0000.0, 000.00, 00.000, 0.0000); the  push-button shifts the decimal point to the left, however the  push-button shifts the decimal point to the right;



The pressure of the  push-button during the change of the parameter value will cause the resignation of the write.

5.4.3 Setting of Archived Registers

The setting of archived registers are carried out in the configuration menu of devices (group dEU_n , where n defines the device number) after choosing the parameter $Ar-EE_n$, where n defines the device number. After choosing the parameter, 10 vertical lines will be displayed on the dis-

play. Lines symbolize registers (from the left side, first read out register). The lighting of lines in green colour means, that the register archiving is enabled. The lighting of lines in red colour means, that the register archiving is disabled.

The first register read out from the device No 0 is placed in the register 8000, however the second read out register in the register 8001 etc. For the second device, the first read out register will be placed in the recorder register 8010. The second register is read out in the register 8011, etc. Remaining read out registers will be placed in a similar way.

During the programming of registers, which have to be archived, the  push-button serves to choose the register number, however the  push-button serves to change the state – to enable or disable the archiving of the given register.

The exemplary view during programming is presented on the fig. 8.

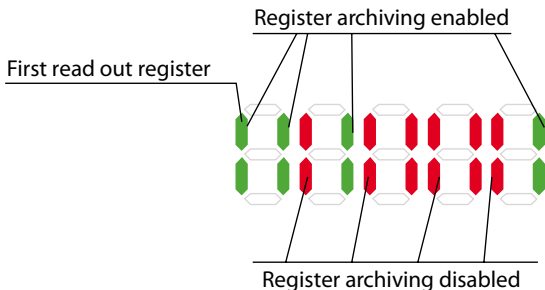

Fig. 8 Way of register archiving presentation

The presented drawing means that for the selected device, read out registers 1, 2, 4 and 10, will be archived. E.g., for the device No 0, that will be registers 8000, 8001, 8003 and 8009.

5.4.4 Characteristic of Programmed Parameters

Programming parameters and the change range of their quantities are presented in the table below.

Table 1

<i>INPUT</i>		
Parameter symbol	Description	Range of changes
<i>rdISP</i>	Selection of displayed register. The selected register can be averaged with the set averaging time and can be submitted to conversion on the base of the individual characteristic.	<i>d0r0</i> .. <i>d9r9</i> – number of the displayed register in the form <i>dnrm</i> , where: <i>n</i> – device number, <i>m</i> – number of read out register from the device. <i>Hour</i> – current time.
<i>Ent</i>	Measurement time expressed in seconds. The result on the display represents the mean value calculated in the <i>Ent</i> . period. This parameter is not taken into consideration during the time display.	1...600 s
<i>RETYPE</i>	Recorder operating type. Defines the way of recorder interface operating and enables the archiving switching on or off.	<i>Stop</i> – Stopping of archiving and device polling. <i>SLU</i> – operating in slave mode without archiving. In the case of a version with an additional output plate, the upper interface operates in the slave mode, however the object interface is not used. For a version without additional outputs, the object interface operates in the slave mode.

	<p>$S_{LU} A$ – similar operation as for S_{LU}, but the archiving is enabled.</p> <p>nAS – Operation in master mode. The interface of the port 1 operates in the master mode, however the interface of the port 2 (on the additional output plate) operates in the slave mode.</p> <p>$nAS A$ – Operation as in the nAS, mode, but the archiving is enabled.</p>
--	--

Table 2

<i>Ind</i>		
Parameter symbol	Description	Range of changes
$IndCP$	Number of points of the individual characteristic. For values lower than two the individual characteristic is disabled. The number of segments is the number of points decreased by one. In the <i>Hour</i> mode, the individual characteristic is not taken into consideration.	1..21
H_n	Value of the point for which we will expect Y_n (n - point number).	-19999..99999
Y_n	Expected value for H_n .	-19999..99999

Table 3



dl SP		
Parameter symbol	Description	Range of changes
dP	Minimal position of the decimal point when displaying the value – display format. This parameter is not taken into consideration during the <i>Hour</i> mode.	0.0000 – 0 00.000 – 1 000.00 – 2 0000.0 – 3 00000 – 4
CoLdo	Display colour, when the displayed value is lower than CoLLo.	rEd – red GrEEn – green orAnG – yellow
CoLbE	Display colour, when the displayed value is higher than CoLLo and lower than CoLHi.	
CoLUP	Display colour, when the displayed value is higher than CoLHi.	
CoLLo	Lower threshold of colour change	-19999..99999
CoLHi	Upper threshold of colour change	-19999..99999
ourLo	Lower threshold of display narrowing. Values lower than the declared threshold are signalled on the display by the symbol  .	-19999..99999
ourHi	Upper threshold of display narrowing. Values higher than the declared threshold are signalled on the display by the symbol  .	-19999..99999

Table 4

ALr1_ ALr2_ ALr3_ ALr4-19999..99999		
Parameter symbol	Description	Range of changes
P_A1_ P_A2_ P_A3_ P_A4_	Input quantity, controlling the alarm.	d0r0 .. d9r9 – Number of the read out register in the form dXrY, where: X – device number, Y – number of the read out register from the device. Hour – current time InP – value on the display
PrL_1_ PrL_2_ PrL_3_ PrL_4_	Lower alarm threshold.	-19999..99999
PrH_1_ PrH_2_ PrH_3_ PrH_4_	Upper alarm threshold.	-19999..99999
tYP_1_ tYP_2_ tYP_3_ tYP_4_	Alarm type. Fig. 11 shows the graphical presentation of alarm types.	non – normal (transition from 0 to 1) noFF – normal (transition from 1 to 0). on – enabled oFF – disabled H-on – Manually enabled. Till the time to change the alarm type, the alarm output remains enabled for good. H-oFF – Manually disabled. Till the time to change the alarm type, the alarm output remains disabled for good.



<p>dLY_1_ dLY_2_ dLY_3_ dLY_4_</p>	<p>Delay of alarm switching.</p>	<p>0...32400 s</p>
<p>LEd_1_ LEd_2_ LEd_3_ LEd_4_</p>	<p>Support of alarm signalling. In situation when the support function is enabled after stopping the alarm state, the signalling diode is not blank. It signals the alarm state till the moment of its blank by means of the   push-button combination. The function concerns only and exclusively the alarm signalling, thus the relay contacts will operate without supporting in accordance with the selected alarm type.</p>	<p>oFF – function disabled oN – function enabled</p>

Table 5

<i>out</i>		
Parameter symbol	Description	Range of changes
<i>P_An</i>	Input quantity, to which the analog output has to react.	<i>d0r0</i> .. <i>d9r9</i> – register number readout in the form <i>dXrY</i> , where: X – device number, Y – register number read out from the device. <i>Hour</i> – current time <i>inp</i> – value on the display
<i>An_Lo</i>	Lower threshold of the analog output. One must give the value, on which we want to obtain a minimal signal value on the analog output.	-19999..99999
<i>An_Hi</i>	Upper threshold of the analog output. One must give the value, on which we want to obtain a maximal signal value on the analog output (10 V or 20 mA).	-19999..99999
<i>typ_A</i>	Type of analog output	<i>0.10V</i> – voltage 0..10 V <i>0.20A</i> – current 0..20 mA <i>4.20A</i> – current 4..20 mA

<i>bAUD</i>	Baud rate of the external interface RS-485 of port 2	4.8 – 4800 bit/s 9.6 – 9600 bit/s 19.2 – 19200 bit/s 38.4 – 38400 bit/s 57.6 – 57600 bit/s 115.2 – 115200 bit/s
<i>Prot</i>	Type of the transmission frame of the external interface RS-485 of port 2.	<i>rBn2</i> <i>rBE 1</i> <i>rBo 1</i> <i>rBn 1</i>
<i>Addr</i>	Recorder address. The write of zero value cause the disable of the port 1 interface.	0..247
<i>bAUD 1</i>	Baud rate of the object interface RS-485 of port 1.	4.8 – 4800 bit/s 9.6 – 9600 bit/s 19.2 – 19200 bit/s 38.4 – 38400 bit/s 57.6 – 57600 bit/s 115.2 – 115200 bit/s
<i>Prot 1</i>	Type of the transmission frame of the interface RS-485 of port 1.	<i>rBn2</i> <i>rBE 1</i> <i>rBo 1</i> <i>rBn 1</i>
<i>t_out</i>	Waiting time to begin the response from the co-operating device of slave type. This time is expressed in milliseconds.	100...5000 ms

Notice! In the version without additional outputs, one can switch the port 1 interface to operate in the interface mode for programming – Operation in the slave mode. Then, the recorder accepts settings in accordance with *bAUD 1*, *t_ryb 1*, *Addr*.

Table 6

SEr		
Parameter symbol	Description	Range of changes
SEt	Write of manufacturer's settings. The setting of YES value causes the write of standard parameters in the recorder. Values of manufacturer's parameters are presented in the table X.	no – do nothing YES – causes the write of manufacturer's settings.
SECUr	Introduction of a new password. The introduction of the value 0 disables the alarm.	0..60000
HoUr	Setting of the current time. Introduction of an erroneous time cancels the introduction of time. The introduced value will not be collected.	0.00..23.59
YERr	Setting of the current year. The introduction of an erroneous year cancels the data introduction. The introduced value will not be collected.	2001...2099
Et	Automatic change of time from summer to winter and inversely.	oFF – automatic change of time disabled oN – automatic change of time enabled.

Unit	Backlight of the unit.	OFF – backlight of units disabled ON – backlight of units enabled
TEST	Display test. The test consist on a successive lighting of digits. Alarm diodes and diodes of unit backlight should be lighted.	NO – do nothing YES – causes the test start. The pressure of the  push-button ends the test.
RIU	Fulfilling of the archive internal memory . This value is not only for readout and is expressed in percentage.	0...100 %
DEL_A	Command to erase the archive internal memory. After choosing YES, archive data will be removed and the value NO will be admitted.	NO – do nothing YES – erase the archive memory
STAT	Displays the state of devices added to the recorder. In case, when one of the bar is in red colour, that means there is a transmission error with the given device. The first bar from the left side symbolizes the device No 0.	No concerned

Table 7

<i>d0r0 .. d9r9</i>		
Parameter symbol	Description	Range of changes
<i>Addr0</i> ... <i>Addr9</i>	Address of the co-operating device. The write of the 0 value disables the data readout from the device.	0..247
<i>r_bA0</i> ... <i>r_bA9</i>	Basic address from which follows the data readout from the device.	0...65535
<i>r_no0</i> ... <i>r_no9</i>	Number of registers read out from the device.	1...10
<i>r_tYP0</i> ... <i>r_tYP9</i>	Type of registers read out from the device.	<p>Read-out registers with function 3</p> <ul style="list-style-type: none"> ∃ <i>CH</i> – 8 bits with a sign. ∃ <i>UCH</i> – 8 bits without a sign. ∃ <i>Sh</i> – 16 bits with a sign. ∃ <i>USH</i> – 16 bits without a sign. ∃ <i>L6</i> – 32 bits with a sign. ∃ <i>UL6</i> – 16 bits without a sign. ∃ <i>FLt</i> – 32-bit register– floating point variable. ∃ <i>F21</i> – value of float type located in two 16-bit registers with bytes sequence 3210. ∃ <i>F12</i> – value of float type located in two 16-bit registers with bytes sequence 1032.

- 3 L2 I – value of long type with a sign located in two 16-bit registers with bytes sequence 3210.
- 3 L I2 – value of long type located in two 16-bit registers with bytes sequence 1032.
- 3UL2 I – value of long type with a sign located in two 16-bit registers with bytes sequence 3210.
- 3UL I2 – value of long type without a sign located in two 16-bit registers with bytes sequence 1032.

Read-out registers with function 4

- 4 CH – 8 bits with a sign.
- 4 UCH – 8 bits without a sign.
- 4 Sh – 16 bits with a sign.
- 4 USh – 16 bits without a sign.
- 4 LB – 32 bits with a sign.
- 4 ULB – 32 bits without a sign.
- 4 FLT – 32-bit register– floating point variable
- 4 F2 I – value of float type located in two 16-bit registers with bytes sequence 3210.
- 4 F I2 – value of float type located in two 16-bit registers with bytes sequence 1032.
- 4 L2 I – value of long type with a sign located in two 16-bit registers with bytes sequence 3210.
- 4 L I2 – value of long type with a sign located in two 16-bit registers with bytes sequence 1032.
- 4UL2 I – value of long type without a sign located in two 16-bit registers with bytes sequence 3210.
- 4UL I2 – value of long type without a sign located in two 16-bit registers with bytes sequence 1032.

<i>FrE90</i> ... <i>FrE99</i>	Sampling period (data read-out from the device Expressed in seconds.	1...60 s
<i>ArE60</i> ... <i>ArE69</i>	Archived registers. The menu serves for the register configuration, which will be archived, and which will be only read-out (see section 5.4.3.).	No concerned
<i>AFr90</i> ... <i>AFr99</i>	Archiving period expressed in tens of second. The value 1 corresponds to the 10 sec time. It defines the length of periods in which data read out from the device have to be placed in the archive.	1...360
<i>AtYP0</i> ... <i>AtYP9</i>	Kind of archiving. The user can choose the continuous archiving or indicate the register which value will decide about the conditional archiving beginning. The archiving begins if the value in the indicated register does not be situated in the range defined by <i>dnPrL</i> and <i>dnPrh</i> , where n – device number.	<i>Cont</i> – continuous archiving <i>rE60</i> ... <i>rE69</i> – register number read out, which the value decides about the beginning of the conditional archiving.

<i>dQP-L</i> ... <i>dQP-L</i>	Lower threshold of the conditional archiving. Below this value, the conditional archiving begins – if this type of archiving has been chosen.	-19999...99999
<i>dQP-H</i> ... <i>dQP-H</i>	Upper threshold of the conditional archiving. Above this value, the conditional archiving begins – if his type of archiving has been chosen.	-19999...99999

5.4.5 Individual Characteristic

N30B recorders can recount the value to display into any value thanks to the implemented individual characteristic function. The individual characteristic rescales the input signal stored/read out through the RS-485 interface. The way of the individual characteristic interaction on the recorder operation has been presented on the fig. 9.

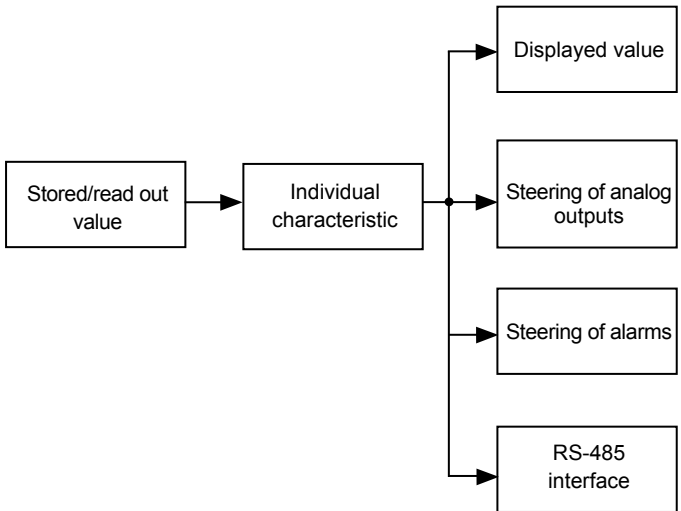

Fig. 9. Action of the individual characteristic.

The user can introduce maximally twenty functions through given points defining intervals and expected values for successive points.

The programming of the individual characteristic consists in the definition of the number of points which the input function will be linearized by. One must remember, that the number of linearizing functions is of one less than the number of points. Next, one must program successive points by giving the measured value (H_n) and the expected value corresponding to it, – value which has to be displayed (Y_n).

The graphic interpretation of the individual characteristic is presented on the fig. 10.

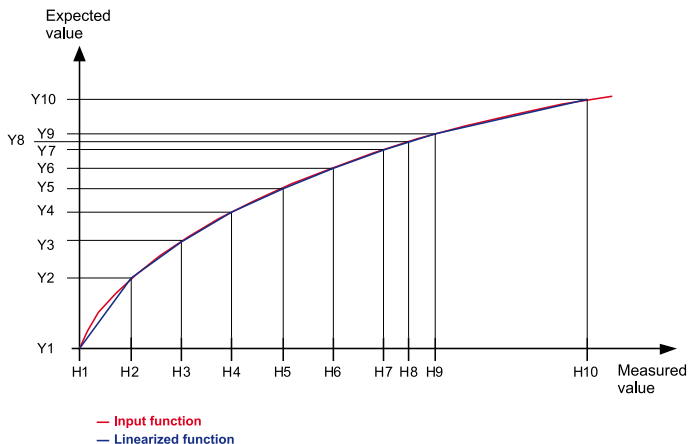

Fig. 10. Individual characteristic.

During the function approximation, one must remember that for the approximation of curves strongly differing from the linear characteristic, higher the number of linearizing segments smaller the error related to the linearization.

If measured values are smallest from H1 then, recalculations will be made on the base of the first straight line calculated on the base of points (H1,Y1) and (H2,Y2). However, for values higher than Hn (where n – the last declared measured value), the value to display will be calculated on the base of the last assigned linear function.

Notice! All introduced points of the measured value (Hn) must be arranged in the increasing sequence, such to preserve the following dependence:

$$H1 < H2 < H3 \dots < Hn$$

If the above is not fulfilled, the individual characteristic function will be automatically switched off (will not be realized) and a diagnostic flag will be set up in the status register.

5.4.6 Alarm Types

The N30B recorder is equipped with 2 alarm outputs with NOC contact (make contact) and two alarm outputs with NOC/NCC contact (make and break contact) (option). Each of alarms can work in one of the six modes. The work of alarms in modes *n-on*, *n-off*, *on*, *off*. is presented in the fig. 11. Two remaining modes: *H-on* and *H-off* mean suitably, always switched on and always switched off. These modes are destined for the manually simulation of alarm states.

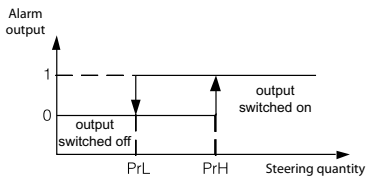

a) $n\text{-on}$

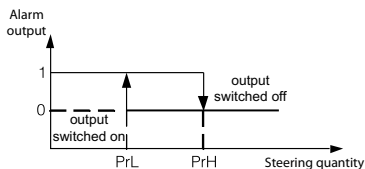

b) $n\text{-off}$

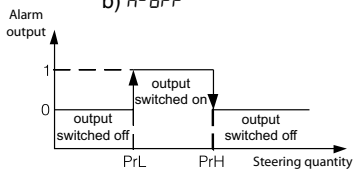

c) on

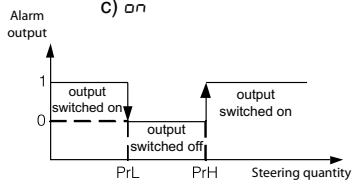

d) off

Fig. 11. Alarm types: a) $n\text{-on}$; b) $n\text{-off}$; c) on ; d) off

Caution!



- In case of alarms of *n-on*, *n-off*, *on*, *off* types, the write of $P_{rL} > P_{rH}$ will cause the alarm switching off.
- In case of a measuring range overflow, the reaction of relays is compatible with written P_{rL} , P_{rH} , tYP .
- The recorder controls currently the value of the introduced parameter at the moment. In case when the introduced value overflows the upper change range given in the table 1, the recorder will make automatically the change into the maximal value. Similarly, in case when the introduced value overflows the lower change range given in the table 1, the recorder will make automatically the change into the minimal value.

5.4.7 Display Format

The N30B recorder adapts automatically the display format (precision) to the value of measured quantity destined to be displayed. So that the function could be fully used, one must choose the format **0.0000**, then the recorder will display the measured value with the possible highest accuracy. This function does not operate for the time display, where the format is set up automatically. The current time (mode *Hour*) is displayed in the 24 hours' format, in the hh.mm shape, where hh – current hour, and mm – current minute.

5.5 Recorder Configuration to Work in the Master Mode

The N30B recorder using the port 1 interface can fulfil the role of master of the MODBUS RTU network, reading out data from added devices. Maximally, the recorder can pool 10 devices, and can maximally read out 10 registers from each device. For data readout from devices the function MODBUS readout of n-registers (No 3) is used. If there is the need to readout a higher number of registers from the given device, one must configure the readout from the device as two devices (e.g. menu dE_{v0} and dE_{v1}) with different basic addresses. The recorder configuration to work in the master mode consists in:

- setting the $RTYPE$ option on the nRS value in the $INPUT$ menu (data readout without archiving or $nRS-A$ (readout and data archiving)).
- configuration of transmission parameters in the OUT menu. One must configure parameters: $BAUD$ (baud rate), $Prot$ (type of data frame) and $t-OUT$ (waiting time to begin the response from co-operating devices).
- configuration of readout parameters from devices. In the dE_{vn} menu, where n – device number, one must configure readout parameters for the given device by giving:
 - the device address $Addr-n$,
 - the basic register from which will follow the readout of $r-n$,
 - the number of registers that will be read out,
 - the type of registers including data in the device from which the readout $rTYPE_n$ will be carried out,
 - the device sampling period expressed in seconds and defining sequences of time in which the device - parameter rFR_n .



- configuration of archiving parameters, data read out from devices. For his aim, one must configure following parameters:
 - $AREGn$ – one must define, which among read out registers have to be archived.
 - $AFRQn$ – one must define the period between successive data records in the archive for the given device.
 - $ALYPn$ – defines the type of archiving. One must choose if the archiving have to be carried out in a continuous way or in dependence of the value in the register controlling the conditional archiving. In case of conditional archiving the parameter $ALYPn$ indicates the read out register number controlling the conditional archiving.
 - $dnPrL$ – lower threshold of the conditional archiving. This parameter has a significance only for a conditional archiving. If the value in the controlling register is lower than the value definite by $dnPrL$, then the archiving of indicated registers takes place with the archiving period determined by the parameter APn .
 - $dnPrH$ – upper threshold of the conditional archiving. This parameter has a significance only for a conditional archiving. If the value in the controlling register is higher than the value definite by $dnPrH$, then the archiving of indicated registers takes place with the archiving period determined by the parameter $AFRQn$.

the operation in the master mode the recorder sounds out devices in the network and read out data from them are available in data registers (registers 8000...8099).

Devices are pooled in a sequence acc. to the configuration ($dEU0$, $dEU1$, $dEU2$ etc.) although the pooling frequency of devices, for a large degree, depends on the rate of devices

operating on the bus. For devices with a long response time it can be happened, that the time between successive data readouts from devices is longer than the time set in the recorder configuration. The difference of times results from the waiting time for the device response and the duration of data transmission. In case of a long waiting time setting for the response and lack of device from which have to follow readouts, the recorder after each query transmission is waiting for the defined time (by the t_out , parameter) , and for this reason, in case if the co-operating device is switched off from the network, one must switch off its service in the N30B recorder through the setting of the variable $Addr_n$ on the value 0 (device switching off).

The recorder operating in the master mode with data archiving (non-zero value of the $ATYPE$ parameter in the $INPUT$ menu) causes, that the recorder archives data in the internal data memory, and in case the memory is full, the data will be automatically copied on the memory card. When the card is missing, the oldest data will be overwritten. The readout of internal data memory, in case of a recorder without additional outputs (port 2) is possible in two ways:

- Location of a memory card in the recorder. After pressing of the   push-button data from the internal archive memory will be automatically copied in the memory card, and after finishing the copying process, data from the internal memory will be erased, so as after the next archive readout only new records will be added in the card. After finishing the copying process (the $SYNCH$ inscription disappears) the card can be disassembled and removed (see recorder service, chapter 5).
- Data readout through the interface of the port 1. For this aim, one must set the $ATYPE$ parameter at the SLU value in the $INPUT$ menu. The object interface will be switched in the slave working mode

with parameters determined by *Addr*, *bAUD1*, *Prot1*. After finishing the data readout, in order to return to the normal operation, one must change the *ATYPE* parameter into the previous value (e.g. *nAS A*).

During the operation in master mode, the user has the possibility to check the co-operation correctness of the recorder with added devices. For this aim, one must choose the *SLAL* option from the *SEr* menu level. Vertical bars will be displayed on the recorder display where the first bar from the left corresponds to the device No 1 (*dEUD*), the second, to the device No 2 (*dEU1*) etc.

Bars in green colour mean a correct communication with the given device. In case of a data transmission error, the bar symbolizing the device lights in red colour.

5.6 Recorder Configuration to Work in the Slave Mode

N30B recorders can operate in the slave mode. For a recorder without additional outputs (port 2) the operation in slave mode is carried out using the port 1 interface. However, for a recorder with assembled upper plate of additional outputs, the operation in slave mode is always carried out using the port 2 located on the plate with additional outputs. This interface always fulfils the slave role, and the choice of the slave mode switches on the possibility to write data in data registers 8000...8099 on, which can be additionally archived.

The recorder switching in the slave mode requires the setting of the *ATYPE* parameter on the *SLU* value in the *INPULt* menu (operation without archiving) or *SLUR* (operation with archiving of recorded values). During the operation in slave mode, connector parameters depend on the used interface. For the port 2 interface, transmission parameters are determined by:

- *Addr* – defines the device address.
- *baud* – baud rate.
- *Prot* – type of the information frame.

For a recorder with the additional plate of outputs, transmission parameters on the port 1 are defined by parameters:

- *Addr 1* – defines the device address.
- *baud 1* – baud rate.
- *Prot 1* – type of the information frame.

After performing the configuration of transmission parameters (*OUT* menu) and choosing the working mode (*INPUT* menu), the recorder is ready to work in slave mode. Data can be recorded and read out from the recorder. For recording data which have to be archived, displayed, have to control alarms or analog outputs, 32-bit registers of float type 8000...8099 (or registers 8200..8399/8400...8599 – float value located in two 16-bit registers) are destined. The value located in data register can be reviewed from the recorder level through the entry in the value monitoring mode (see section 5.3).

Values stored in register 8000..8099 can be archived. The archiving is carried out in a similar way as archiving in the master working mode (see section 5.5.), where read out values from devices are located in registers 8000...8099. In order to switch the archiving of the given register on, one must set the *ARCHn* variable (*n* – device number) in the *DEVn* menu. Although, the first ten registers (8000..8009) are available in the *DEV0* menu etc. The second group of ten registers are available in the *DEV1* menu, etc. The kind of archiving depends on the *ALYPn* parameter. However the archiving period is defined by the *AFR9n* parameter.

The archive readout in slave mode can be carried out directly by the mediation of the interface operating in the slave mode or through copying the archive on the memory card

(see section 5.5.). The degree of archive occupation can be checked in the *SEr* menu of the recorder (*RIU* parameter). From the *SEr* menu level, one can erase the archive contents (*dEL_A* parameter).

During the data archiving configuration in slave mode, one must remember that the configuration of archived registers is carried out in 10 groups, where for each group, one can configure parameters related to: archived register, frequency and archiving type. The detailed recorder register map and serviced functions are presented in the chapter 8.

5.7 Manufacturer's Parameters

Standard settings of the N30B recorder are presented in the table 5. These settings can be restored by means of the recorder menu through the choice of the option *SEt* from the menu *SEr*.

Table 8

Parameter symbol	Matrix level	Default value
<i>rdISP</i>	1	<i>Hour</i>
<i>Cnt</i>	1	1
<i>ATYPE</i>	1	<i>Stop</i>
<i>IndCP</i>	2	no
<i>HD</i>	2	0
<i>YD</i>	2	0
<i>HI</i>	2	100
<i>YI</i>	2	100

H_n	2	$(n-1)*100$
Y_n	2	$(n-1)*100$
dP	3	0
$CoLdo$	3	$ErEE_n$
$CoLbE$	3	$orAnGE$
$CoLUP$	3	rEd
$CoLHi$	3	5000
$CoLLo$	3	8000
$ourLo$	3	-19999
$ourHi$	3	99999
$P_A 1, P_A 2, P_A 3, P_A 4$	4, 5, 6, 7	$dDrD$
$tYP 1, tYP 2, tYP 3, tYP 4$	4, 5, 6, 7	$H-oFF$
$PrL 1, PrL 2, PrL 3, PrL 4$	4, 5, 6, 7	1000
$PrH 1, PrH 2, PrH 3, PrH 4$	4, 5, 6, 7	2000
$dLY 1, dLY 2, dLY 3, dLY 4$	4, 5, 6, 7	0
$LEd 1, LEd 2, LEd 3, LEd 4$	4, 5, 6, 7	oFF
PA_n	8	$dDrD$
An_Lo	8	0
An_Hi	8	99999
tYP_A	8	D_1DU
$bAUd$	8	9.6
$Prot$	8	rBn^2
$Addr$	8	1
$bAUd 1$	8	9.6
$Prot 1$	8	rBn^2
t_oUt	8	500

<i>SEt</i>	9	<i>no</i>
<i>SECUr</i>	9	0
<i>HoUr</i>	9	No concerned
<i>YEAR</i>	9	No concerned
<i>Et</i>	9	<i>oFF</i>
<i>Unit</i>	9	<i>oFF</i>
<i>tESt</i>	9	<i>no</i>
<i>Al U</i>	9	0
<i>dEL_A</i>	9	<i>no</i>
<i>StAt</i>	9	No concerned
<i>Addr0 ... Addr9</i>	10...19	<i>oFF</i>
<i>r_bA0 ... r_bA9</i>	10...19	7505
<i>r_no0 ... r_no9</i>	10...19	1
<i>r_tYP0 ... r_tYP9</i>	10...19	3 <i>Flt</i>
<i>rFr90 ... rFr99</i>	10...19	1
<i>ArE60 ... ArE69</i>	10...19	0
<i>AFr90 ... AFr99</i>	10...19	1
<i>AtYP0 ... AtYP9</i>	10...19	<i>Cont</i>
<i>dOPrL ... dOPrL</i>	10...19	100
<i>dOPrH ... dOPrH</i>	10...19	200

6. INTERNAL ARCHIVE

N30B recorders are equipped in standard with an internal memory destined to store registered data by the recorder. The recorder memory allows to store 308000 records. The memory have the character of a circular buffer. After fulfilling the memory, the oldest data are overwritten. The internal archive can be read out, copied and erased.

After the insertion of the memory card, follows it's checking, archiving of the date and time of its insertion. After fulfilling the internal archive, the data will be automatically transferred onto the card. The further archiving is carried out in the internal memory. In every moment one can copy the data from internal memory onto the memory card through pressing the

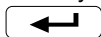

push-button.



6.1 Memory Structure

The internal recorder memory is divided in 7000 pages. 44 records of archived data can be located in each memory page. On the page, records begin always from the beginning of the page and occupy the whole page space. Each memory page includes 528 bytes (one can store together 308000 records).

The beginning of archive data is determined by the page number on which there is the first archive record and by the initial byte determining from which byte begins the first record.

The archive end is determined in the similar way through the page number on which there is the last page record and the byte where begins the record of the next archive record.

Data of internal archive memory are stored in the shape of records including 12 bytes.

6.2 Record Construction

All data in the internal data memory are stored in the shape of records composed of 12 bytes. The record structure is presented in the table 9.

Table 9

Field name	Value range	Description	Field type
ID	0..9	Knot identifier – Device number from which the data origins	byte
RegID	0..9	read out register number, which the value is stored	byte
Year	1..255	Year. Value 9 means 2009.	byte
Month	1..12	Month.	byte
Day	1..31	Day.	byte
Hour	0..23		byte
Minute	0..59		byte
Second	0..59		byte
Data	---	Data archived in the float format	4 bytes

6.3 Archive Data Downloading

Downloading of archive data from the internal memory is carried out through the mediation of the memory card or through the interface operating in the slave mode (see sections 5.5 and 5.6).

The algorithm of archive data downloading through the mediation of the RS-485 interface is presented below. The presented description includes only the way to download data without the description of further data processing and data conversion.

The archive data downloading consists to download successive memory pages including records with data. The archive downloading algorithm is presented on the fig. 12.

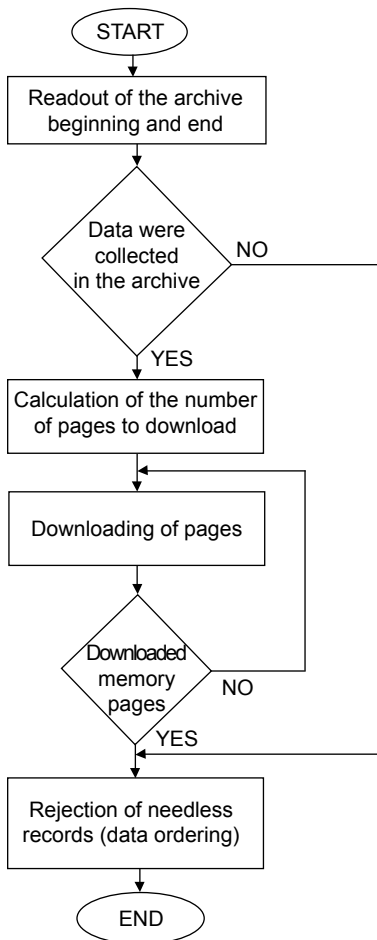

Fig. 12. Algorithm of archive readout from the internal memory.

Acc. to the presented figure above, in order to download data from the internal archive memory, one must download in the first sequence the beginning and the end of the archive (values in registers 4046..4049). On the base of registers 4046 and 4047, determine the number of pages to download from equations:

$Is = R_{4047} - R_{4046} + 1$; or from the equation: $Is = 7000 + R_{4046} - R_{4047}$, if the value of the initial page is higher than the value of the last page (the memory has the structure of a circular buffer).

If the initial page and the last page are equal each other and registers 4048 and 4049 are equal each other, that means that the archive is empty. In the contrary, download the number Is of pages, beginning from the indicated page by the register 4046. After writing the number of the read out page in the register 4500, one can read out from registers 4501...4764 the page contents from the internal memory. Begin the page downloading by the write of the page number, which we want to download in the register 4500, and next the readout of registers 4501...4764 ((memory page with number placed in the register 4500). We download all pages in the similar way, till the moment of downloading of all required pages (Is). After downloading the memory contents, we divide the downloaded contents into records (1 record equals 12 bytes). After performing the division into records, filter data by the rejection of records in front, then the number of records to be rejected in front is calculated as the contents of the register 4048/12. after the rejection of records in front, reject records from the end.

The number of records to reject from the end is calculated as: $528 - \text{value of register } 4049/12$.

After the rejection of records we obtain ready data in the memory (e.g. in the table).

7. MEMORY CARD

N30B recorders are serviced by memory cards of MMC and SD types and capacity up to 4 GB. The FAT and FAT32 system of files is serviced. In case, when the possessed memory card is not formatted, one must carry out its formatting in the card reader from the computer level. During the work, the N30B recorder creates catalogues and files including archived data. Before the card insertion into the recorder, one must check whether the card does not have a switched protection against recording.

Notice! One must never pull out the memory card from the recorder before its disassembling when the data are transferred from the internal memory onto the card (see section 5.3).

The memory card state is displayed by the marker placed on the recorder display (see section 5.1.) and is contained in the recorder's registers (see section 8.4.).

Below an exemplary number of records on the card for 10 archived devices (with 10 registers in each) with the quickest updating time (every 10 seconds):

- 64 MB: ca 4 320 000 records (ca 120 hours – 5 days)
- 512 MB: ca 34 560 000 records (ca 960 hours – 40 days)
- 2 GB: ca 136 512 000 records (ca 3792 hours – 158 days)

Notice! The time needed to transfer the data from internal memory depends on the card and can take even about an hour.

7.1 Catalogue Structure

The N30B recorder installs catalogues and files in the memory card during archiving. The exemplary catalogue structure is presented on the fig. 13.

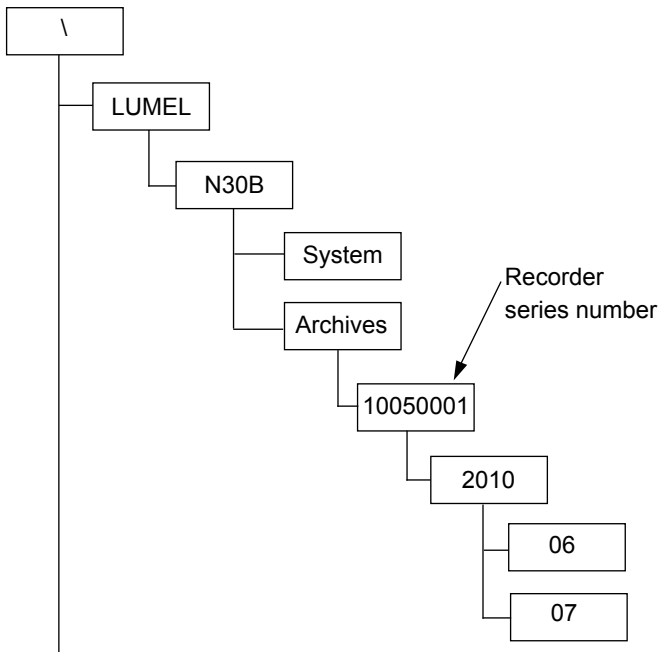

Fig. 13 Catalogue structure in the memory card.

Beyond the Archives catalogue, the System catalogue is also created on the card, in which the start.txt file is placed. The date and time of the memory card initialization is stored in this file (also during the start after a supply decay). Data on the card are stored in files located in catalogues corresponding to the date – see fig 13. However, file names correspond to numbers of the archiving day: Day_01.dat, Day_02.dat, etc.

7.2 Construction of Archive Files

Files including archive data, have a bar (column) construction, where successive data bars are separated between them by the tabulator mark. In the first file row, the bar heading is placed. Data records are arranged successively in rows, and fields of the given record are separated between them by the tabulation mark. The view of an exemplary file is presented on the fig. 14.

date	time	DEV	R0	R1	R2	R3	R4	R5	R6	R7	R8	R9
2009-12-03	16:57:00			1	2.236000e+01		3.286079e+01	*	*	*	*	*
2009-12-03	16:58:00			1	2.232000e+01		3.310589e+01	*	*	*	*	*
2009-12-03	16:59:00			1	2.231000e+01		3.317587e+01	*	*	*	*	*
2009-12-03	17:02:00			1	2.225000e+01		3.331576e+01	*	*	*	*	*
2009-12-03	17:03:00			1	2.222000e+01		3.328080e+01	*	*	*	*	*
2009-12-03	17:04:00			1	2.220000e+01		3.328080e+01	*	*	*	*	*
2009-12-03	17:05:00			1	3.218000e+01		3.335072e+01	*	*	*	*	*
2009-12-03	17:07:00			1	2.217000e+01		3.338567e+01	*	*	*	*	*
2009-12-03	17:12:00			1	2.207000e+01		3.335072e+01	*	*	*	*	*
2009-12-03	17:14:00			1	3.204000e+01		3.349050e+01	*	*	*	*	*
2009-12-03	17:15:00			1	2.206000e+01		3.359528e+01	*	*	*	*	*
2009-12-03	17:16:00			1	2.206000e+01		3.338567e+01	*	*	*	*	*
2009 12 03	17:17:00			1	3.204000e+01		3.342062e+01	*	*	*	*	*
2009-12-03	17:18:00			1	2.201000e+01		3.335072e+01	*	*	*	*	*
2009-12-03	17:19:00			1	2.200000e+01		3.331576e+01	*	*	*	*	*
2009 12 03	17:20:00			1	2.197000e+01		3.335072e+01	*	*	*	*	*
2009-12-03	17:23:00			1	2.197000e+01		3.370000e+01	*	*	*	*	*
2009-12-03	17:24:00			1	2.202999e+01		3.401387e+01	*	*	*	*	*
2009 12 03	17:25:00			1	2.210000e+01		3.390930e+01	*	*	*	*	*
2009-12-03	17:26:00			1	2.215000e+01		3.390930e+01	*	*	*	*	*
2009-12-03	17:27:00			1	2.220000e+01		3.383956e+01	*	*	*	*	*
2009-12-03	17:20:00			1	2.224000e+01		3.390930e+01	*	*	*	*	*
2009-12-03	17:29:00			1	2.230000e+01		3.390930e+01	*	*	*	*	*
2009-12-03	17:30:00			1	2.234000e+01		3.390930e+01	*	*	*	*	*

Fig. 14 Exemplary file with data.

Successive fields included in the row and describing the record have the following meaning:

- date – date of data registration. The date separator is the mark: '-'.
- time – time of data registration. The time separator is the mark: ':'.
- DEV – device number – value 0 for dev0, 1 for dev1, etc.
- R0..R9 – value of successive registers. The decimal point is the dot: '.'. Values are stored in the engineer's format allowing to preserve the precision.

Notice: The number of rows in the file depends on the number of stored data. For 10 devices archived 10 seconds, the number of lines in the daily file is 86402 (8640 for each device). For this reason, before beginning the data analysis, one must be sure that the used program (e.g.: Excell) services such a number of rows.

8. INTERFACE RS-485

Programmable digital N30B recorders have one or two serial links in RS-485 standards for the communication in computer systems and with other devices fulfilling Master or slave functions. An asynchronous communication character protocol MODBUS has been implemented on the serial link (links).

8.1 Connection Way of the Serial Interface

The RS-485 standard allows to a direct communication of 32 devices on a single serial link of 1200m long (at baud rate 9600 b/s). For the connection of a higher quantity of devices, it is necessary to apply additional intermediate-separating systems, e.g. PD51 converter, of LUMEL S.A.'s production.

The outlet of the interface line is presented on the fig. 4. To obtain a correct transmission, it is necessary to connect lines A and B in parallel with their equivalents in other devices. The connection must be made through a screened wire. The wire screen must be connected to the protective terminal in the nearest possible proximity of the recorder (connect the screen only to a single point of the protective terminal).

The GND line serves to the additional protection of the interface line at long connections. Then, one must connect GND signals of all devices on the RS-485 bus.

To obtain the connection with the computer, a RS-485 interface card or a suitable converter is indispensable, or a suitable converter as e.g. PD51 or PD10.

The connection way of devices is shown on the fig. 15.

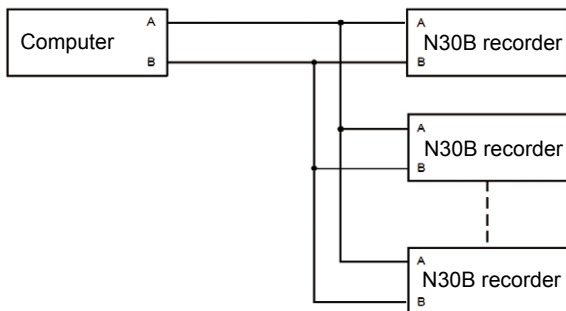

Fig. 15. Connection Way of the RS-485 Interface.

The designation of transmission lines for the card in the PC computer depends on the card producer.

8.2 Description of the MODBUS Protocol Implementation.

The implemented protocol is in accordance with the PI-MBUS-300 Rev G of Modicon Company specification.

Set of the serial link parameters of N30B recorders in MODBUS protocol:

- recorder address: 1..247.
- baud rate: 4800, 9600, 19200, 38400, 57600, 115200 [b/s].
- work mode: RTU z ramką w formacie: 8n2, 8e1, 8o1, 8n1.
- maximal time to start the response: 200 ms (work without card), 1000 ms (work with a card).

The parameter configuration of the serial link consists in the settlement of the baud rate (*bAUD* or *bAUD1* parameter), device address (*Addr* parameter), and the format of the informa-

tion unit (*Prot* or *Prot I* parameter).

Notice: Each device connected to the communication network must have:

- unique address, different from addresses of other devices connected to the network.
- identical baud rate and type of information unit.

8.3 Description of Applied Functions

Following functions of the MODBUS protocol have been implemented in the N30B recorder:

- 03, 04 – Readout of register group.
- 06 – Write of one register (only during the slave mode operation).
- 16 – Write of register group (only during the slave mode operation).
- 17 – Identification of the slave device (only during the slave mode operation).

8.4 Register Map

The N30B recorder data are placed in 16- and 32-bit registers. Process variables and meter parameters are placed in the address space of registers in a manner dependent on the type of the variable. The bits in the 16-bit register are numbered from the youngest to the oldest (b0-b15). 32-bit registers contain numbers of float type in IEEE-754 standard.

Notice: All given addresses are physical addresses. In some computer programs, logic addressing is applied, then addresses must be increased of 1.

Table 10

Range of addresses	Value type	Description
4000-4062, 4300-4379	integer (16 bits)	Value placed in a 16-bit register. Registers can be read out and recorded.
4500-4764,	integer (16 bits)	Value placed in a 16-bit register. Enables the readout of the archive internal memory contents.
6000-6099	float (2x16 bits)	Value placed in two successive 16-bit registers. Registers include the same data as 32-bit registers from the area 7500-7549. Registers are only for readout. Bytes sequence (1-0-3-2).
6200-6367	float (2x16 bits)	Value placed in two successive 16-bit registers. Registers include the same data as 32-bit registers from the area 7600-7683. Registers can be read out and recorded. Bytes sequence (1-0-3-2).
7000-7099	float (2x16 bits)	Value placed in two successive 16-bit registers. Registers include the same data as 32-bit registers from the area 7500-7549. Registers are only for readout. Bytes sequence (3-2-1-0).

7200-7367	float (2x16 bits)	Value placed in two successive 16-bit registers. Registers include the same data as 32-bit register from the area 7600-7683. Registers can be read out and recorded. Bytes sequence (3-2-1-0).
7500-7549	float (32 bity)	Value placed in a 32-bit register. Registers are only for readout. Bytes sequence (3-2-1-0).
7600-7683	float (32 bity)	Value placed in a 32-bit register. Registers can be read out and recorded. Bytes sequence (3-2-1-0).
8000-8099	float (32 bity)	Value placed in a 32-bit register. Registers can be read out and recorded. Bytes sequence (3-2-1-0).
8200-8399	float (2x16 bits)	Value placed in two successive 16-bit registers. Registers include the same data as 32-bit register from the area 8000. Registers can be read out and recorded. Bytes sequence (3-2-1-0).
8400-8599	float (2x16 bits)	Value placed in two successive 16-bit registers. Registers include the same data as 32-bit register from the area 8000. Registers can be read out and recorded. Bytes sequence (1-0-3-2).

8.5 Registers for Write and Readout

Table 11

Values placed in 16-bit registers	Symbol	write (w)/ readout (r)	Range	Description	
4000	<i>rdISP</i>	w/r	0..100	Number of the displayed register. Defines which read out register will be displayed. Registers 0..9 – values read out from the device number 1. Registers 10..19 – read out from the device number 2, etc. Value 100 means, that the time will be displayed.	
4001		w/r		Reserved	
4002		w/r		Reserved	
4003	<i>Cnt</i>	w/r	1..600	Measurement time expressed in seconds. This time defines the averaging time of the measured (displayed) value. The displayed value is the mean value calculated from the <i>Cnt</i> period.	
4004	<i>ATYPE</i>	w/r	0..4	Archiving status:	
				Value	Description
				0	<i>STOP</i> - stoppage of device archiving and pooling
				1	<i>SLV</i> – work in slave mode without archiving
				2	<i>SLV A</i> – work in slave mode with archiving
				3	<i>MS</i> – work in master mode with archiving disabled
4	<i>MS A</i> – work in master mode with archiving enabled				
4005		w/r		Reserved	

4006		w/r		Reserved	
4007		w/r		Reserved	
4008	<i>indCP</i>	w/r	1..21	Number of points of the individual characteristic. For the value 1, the individual characteristic is disabled. Segments of the individual characteristic are defined by parameters Xn and Yn, where n – point number.	
4009	<i>dP</i>	w/r	0..4	Minimal position of the decimal point when displaying the measured value.	
				Value	Description
				0	0.0000
				1	00.000
				2	000.00
				3	0000.0
4010	<i>colLo</i>	w/r	0..2	Display colour when the displayed value is lower than <i>colLo</i> .	
				Value	Description
				0	red
				1	green
				2	orange
				4011	<i>colbE</i>
Value	Description				
0	red				
1	green				
2	orange				
4012	<i>colUP</i>	w/r	0..2		
				Value	Description
				0	red
				1	green
				2	orange

4013	P_R 1	w/r	0...101	Input quantity which the alarm output has to react on	
				Value	Description
				0..99	Number of read out register from the device
				100	Main input
				101	Clock
4014	tYP_1	w/r	0...5	Type of alarm 1 (description – fig 11)	
				Value	Description
				0	n-on
				1	n-off
				2	on
				3	off
				4	H-on
5	H-off				
4015	dLY_1	w/r	0..32400	Delay of alarm 1(in seconds)	
4016	LEd_1	w/r	0...1	Support of alarm 1 signalling	
				Value	Description
				0	Support disabled
				1	Support enabled
4017	P_R 2	w/r	0...101	Input quantity which the alarm output has to react on	
				Value	Description
				0..99	Number of read out register from the device
				100	Main input
				101	Clock

4018	tYP_2	w/r	0...5	Type of alarm 2 (description – fig. 11)	
				Value	Description
				0	n-on
				1	n-off
				2	on
				3	off
				4	H-on
5	H-off				
4019	dLY_2	w/r	0.. 32400	Delay of alarm 2 (in seconds)	
4020	LEd_2	w/r	0...1	Support of alarm 2 signalling	
				Value	Description
				0	Support disabled
1	Support enabled				
4021	P_R_3	w/r	0... 101	Input quantity which the alarm output has to react on	
				Value	Description
				0..99	Number of read out register from the device
				100	Main input
101	Clock				
4022	tYP_3	w/r	0...5	Type of alarm 3 (description – fig.11)	
				Value	Description
				0	n-on
				1	n-off
				2	on
				3	off
				4	H-on
5	H-off				
4023	dLY_3	w/r	0... 32400	Delay of alarm 3 (in seconds)	

4024	LEd_3	w/r	0...1	Support of alarm 3 signalling	
				Value	Description
				0	Support disabled
				1	Support enabled
4025	P_R_4	w/r	0...101	Input quantity which the alarm output has to react on.	
				Value	Description
				0..99	Number of read out register from the device
				100	Main input
			101	Clock	
4026	tYP_4	w/r	0...5	Type of alarm 4 (description – fig. 11)	
				Value	Description
				0	n-on
				1	n-off
				2	on
				3	off
				4	H-on
5	H-off				
4027	dLY_4	w/r	0...32400	Delay of alarm 4(in seconds)	
4028	LEd_4	w/r	0...1	Support of alarm 4 signalling	
				Value	Description
				0	Support disabled
			1	Support enabled	
4029	P_Rn	w/r	0...101	Input quantity, which the analog output has to react on.	
				Value	Description
				0..99	Register number read out from devices
				100	Main input
			101	Clock	

4030	<i>TYPE</i>	w/r	0...2	Type of analog output	
				Value	Description
				0	Voltage input 0..10V
				1	Current input 0..20mA
				2	Current input 4..20mA
4031	<i>BAUD</i>	w/r	0...5	Baud rate of the port 2 interface	
				Value	Description
				0	4800 bit/s
				1	9600 bit/s
				2	19200 bit/s
				3	38400 bit/s
				4	57600 bit/s
				5	115200
4032	<i>PROT</i>	w/r	0..3	Transmission mode of the external interface	
				Value	Description
				0	RTU 8N2
				1	RTU 8E1
				2	RTU 8O1
				3	RTU 8N1
4033	<i>ADDR</i>	w/r	0... 247	<p>Device address. The write of the value 0 causes the port 2 interface switching off.</p> <p>Notice: in the version without additional outputs, one can switch the port 1 interface to work in the interface mode for programming – see the recorder service. Then, the recorder accepts settings in compliance with <i>BAUD</i>, <i>TYPE</i> and <i>ADDR</i> parameters.</p>	
4034	<i>SAVE</i>	w/r	0...1	Update transmission parameters. Causes the application of introduced RS-485 interface settings.	

4035	bRud l	w/r	0..5	Baud rate of the port 1 interface	
				Value	Description
				0	4800 bit/s
				1	9600 bit/s
				2	19200 bit/s
				3	38400 bit/s
				4	57600 bit/s
5	115200 bit/s				
4036	tRyb l	w/r	0..3	Transmission mode of the port 1 interface	
				Value	Description
				0	RTU 8N2
				1	RTU 8E1
				2	RTU 8O1
3	RTU 8N1				
4037	t_oUt	w/r	100..5000	Waiting time for the response from devices expressed in milliseconds	
4038	SEt	w/r	0, 1	Write of standard parameters	
				Value	
				0	Without change
1	Set standard parameters				
4039	SECUr	w/r	0...60000	Password for parameters	
				Value	
				0	Without password
...	Input into parameters preceded by the query for password				
4040	HoUr	w/r	0...2359	Current time	
				This parameter occurs in the ggmm format where: gg – means hour, mm – means minute the introduction of erroneous hours will cause the setting 23, however the introduction of erroneous minutes will cause the setting 59.	

4041	dRtE	w/r	101.. 1231	Current date in month *100 + day format	
4042	YEAR	w/r	2001.. 2099	Current year in YYYY format.	
4043	Et	w/r	0, 1	Automatic change of time summer/winter and inversely.	
				Value	Description
				0	disabled
				1	enabled
4044	Unit	w/r	0, 1	Switching the unit backlight on and off	
				Value	
				0	Backlight switched off
				1	Backlight switched on
4045	dEL_R	w/r	0, 1	Erase the archive contents. The write of the value 1 causes the archive erasing and setting the value 0 in the register.	
4046		O	0... 7956	Memory page defining the memory beginning.	
4047		O	0... 7956	Memory page defining the memory end.	
4048		O	0... 527	Byte defining the archive beginning. The value in the register shows from which byte of archive beginning begins the archive.	
4049		O	0... 527	Byte defining the archive end. The value in the register shows the successive byte under which the archive record will be written.	
4050	StRE	O	0... 1023	Status of added devices, the bit setting in the given position signals a communication error in the given device. The bit 0 corresponds to the first device.	

4051	SEAL I	w/r	0.. 65535	Recorder status. Describes the current recorder state. Successive bits present event data. The set bit on 1 means that the event took place. Events can be only erased.	
				Bit 15	Supply break
				Bit 14	RTC clock – loss of settings
				Bit 13	Not used
				Bit 12	Lack of communication with data memory
				Bit 11	Erroneous settings
				Bit 10	Manufacturer' settings restored
				Bit 9	Lack of measured values in data memory
				Bit 8	Not used
				Bit 7	Output plate has been found out
				Bit 6	Output plate –error or lack of calibration
				Bit 5	Not used
				Bit 4	Not used
				Bit 3	Erroneous configuration of individual characteristic.
				Bit 2	Not used
Bit 1	Not used				
Bit 0	The averaging period has not been expired.				

4052	5LRLE2	w/r		Recorder status. Describes the current recorder state. Successive bits represent event data. The bit set on 1 means, that the event took place. Events can be only erased.	
				Bit 15	Not used
				Bit 14	Not used
				Bit 13	Not used
				Bit 12	Not used
				Bit 11	Not used
				Bit 10	Not used
				Bit 9	Not used
				Bit 8	Not used
				Bit 7	LED4 – Signalling of alarm No 4.
				Bit 6	LED3 – Signalling of alarm No 3.
				Bit 5	LED2 – Signalling of alarm No 2.
				Bit 4	LED1 – Signalling of alarm No 1.
				Bit 3	State of the alarm relay No 4.
				Bit 2	State of the alarm relay No 3.
Bit 1	State of the alarm relay No 2.				
Bit 0	State of the alarm relay No 1.				
4053	EF	r	0, 1	Reserved (time flag).	
4054		r	0...5	Status of memory card:	
				Value	Description
				0	Lack of card.
				1	Card inserted, but not initiated (disassembled).
2	Card inserted, but the initiation test is ended by an error.				

				3	Card inserted, correctly initiated but the protection against writing is switched on. After detecting against writing, the card is automatically disassembled.
				4	Card inserted and initiated with success.
				5	Card inserted and initiated with success, but entirely filled.
4055		w/r	0, 1		Erasing of minimum and maximum values. The write of value 1 causes the erase of minimum and maximum values and sets the register on the value 0.
...			Reserved
4061		w/r	0... 65535		MSB serial number
4062		w/r	0... 65535		LSB serial number

Series number = Register₄₀₆₁ *65536 + Register₄₀₆₂

Table 12

The value is placed in 16-bit registers	Symbol	Write (z) readout (o)	Range	Description
Device number 0				
4300	<i>Addr0</i>	w/r	0... 247	Device address number 0. The write of value 0 switches the readout and archiving off from the given device.
4301	<i>r_bAD</i>	w/r	0... 65535	Basic address – address from which the readout will follow.

4302	r_no0	w/r	1..10	Number of read out registers from the device or number of data in case of float registers located in two 16-bit registers.	
4303	r_t9P0	w/r	0...7	Type of being read out register:	
				Value	Description
				Read-out registers with the function 3 of Modbus	
				0	Register of <i>char</i> type (8 bits with sign)
				1	Register of <i>unsigned char</i> type(8 bits without sign)
				2	Register of <i>short</i> type (16 bits with sign)
				3	Register of <i>unsigned short</i> type(16 bits without sign)
				4	Register of <i>long</i> type (32 bits with sign)
				5	Register of <i>unsigned long</i> type (32 bits without sign)
				6	Register of <i>float</i> type(32 bits variable comma with sign)
				7	Register of <i>float</i> type (2 x 16 bits with sequence 3210)
8	Register of <i>float</i> type (2 x 16 bits with sequence 1032)				
9	Register of <i>long</i> type (2 x 16 bits with sequence 3210 with a sign)				
10	Register of <i>long</i> type (2 x 16 bits with sequence 1032 with a sign)				

				11	Register of <i>unsigned long</i> type (2 x 16 bits with sequence 3210 without a sign)
				12	Register of <i>unsigned long</i> type (2 x 16 bits with sequence 1032 without a sign)
				Read-out registers with the function 4 of Modbus	
				13	Register of <i>char</i> type (8 bits with sign)
				14	Register of <i>unsigned char</i> type (8 bits without sign)
				15	Register of <i>short</i> type (16 bits with sign)
				16	Register of <i>unsigned short</i> type (16 bits without sign)
				17	Register of <i>long</i> type (32 bits with sign)
				18	Register of <i>unsigned short</i> type (32 bits without sign)
				19	Register of <i>float</i> type (32 bits variable comma with sign)
				20	Register of <i>float</i> type (2 x 16 bits with sequence 3210)
				21	Register of <i>float</i> type (2 x 16 bits with sequence 1032)
				22	Register of <i>long</i> type (2 x 16 bits with sequence 3210 with a sign)
				23	Register of <i>long</i> type (2 x 16 bits with sequence 1032 with a sign)
				24	Register of <i>unsigned long</i> type (2 x 16 bits with sequence 3210 without a sign)

				25	Register of <i>unsigned long</i> type (2 x 16 bits with sequence 1032 without a sign)
4304	<i>rFr90</i>	w/r	1..60	Scanning period (data readout) from the device, expressed in seconds.	
4305	<i>RrE60</i>	w/r	0..1023	Registers are defined on successive bits, which have to be archived. So, bit 0 defines that the first read out register has to be archived. Bit 1 means that the second register has to be archived, etc.	
4306	<i>RFr90</i>	w/r	1..360	The archiving period expressed in tens of a second, determines every which period, data have to be stored in the memory.	
4307	<i>RtYP0</i>	w/r	0..10	Kind of archiving – number of the register releasing the conditional archiving.	
				Value	Description
				0	Continuous archiving
				1	The value of the first read out register decides about the archiving beginning. If the read out value does not fit in the range definite by d0PrL and d0PrH, the archiving with period follows.
				2	The value of the second read out register decides about the archiving beginning.
				3	The value of the third read out register decides about the archiving beginning.
				4	The value of the fourth read out register decides about the archiving beginning.

				5	The value of the fifth read out register decides about the archiving beginning.
				6	The value of the sixth read out register decides about the archiving beginning.
				7	The value of the seventh read out register decides about the archiving beginning.
				8	The value of the eighth read out register decides about the archiving beginning.
				9	The value of the ninth read out register decides about the archiving beginning
				10	The value of the tenth read out register decides about the archiving beginning.
Device number 1					
4308	<i>Addr 1</i>	w/r	0..247	Address of the device number 1. The write of value 0 switches the readout and archiving from the given device off.	
4309	<i>r_bA 1</i>	w/r	0...65535	Basic address – address which the readout will follow from.	
4310	<i>r_no 1</i>	w/r	1..10	Number of read out registers from the device or number of data in case of float registers located in two 16-bit registers.	
4311	<i>r_tYP 1</i>	w/r	0..25	Type of being read out register:	
				Value	Description
				The same data as for register 4303	
4312	<i>rFrq 1</i>	w/r	1..60	Scanning period (data readout) from the device, expressed in seconds.	

4313	<i>AREB I</i>	w/r	0..1023	Registers are defined on successive bits, which have to be archived. So, bit 0 defines that the first read out register has to be archived. Bit 1 means that the second register has to be archived, etc.	
4314	<i>ARFPI</i>	w/r	1..360	The archiving period expressed in tens of a second, determines every which period, data have to be stored in the memory.	
4315	<i>ALYP I</i>	w/r	0..10	Kind of archiving – number of the register releasing the conditional archiving.	
				Value	Description
				0	Continuous archiving
				1	The value of the first read out register decides about the archiving beginning. If the read out value does not fit in the range definite by <i>dOPrL</i> and <i>dOPrH</i> , the archiving with period follows.
				2	The value of the second read out register decides about the archiving beginning.
				3	The value of the third read out register decides about the archiving beginning.
				4	The value of the fourth read out register decides about the archiving beginning.
				5	The value of the fifth read out register decides about the archiving beginning.

				6	The value of the sixth read out register decides about the archiving beginning.
				7	The value of the seventh read out register decides about the archiving beginning.
				8	The value of the eighth read out register decides about the archiving beginning.
				9	The value of the ninth read out register decides about the archiving beginning.
				10	The value of the tenth read out register decides about the archiving beginning.
Device number 2					
4316	<i>Rddr2</i>	w/r	0...247	Device address number 2. The write of value 0 switches the readout and archiving off from the given device.	
4317	<i>r_bR2</i>	w/r	0...65535	Basic address – address which the readout will follow from.	
4318	<i>r_no2</i>	w/r	1..10	Number of read out registers from the device or number of data in case of float registers located in two 16-bit registers.	
4319	<i>r_tYP2</i>	w/r	0...25	Type of being read out register:	
				Value	Description
				The same data as for register 4303	
4320	<i>rFr92</i>	w/r	1..60	Scanning period (data readout) from the device, expressed in seconds.	
4321	<i>RrEE2</i>	w/r	0..1023	Registers are defined on successive bits, which have to be archived. So, bit 0 defines that the first read out register has to be archived. Bit 1 means that the second register has to be archived, etc.	

4322	<i>RFr92</i>	w/r	1..360	The archiving period expressed in tens of a second, determines every which period, data have to be stored in the memory.	
4323	<i>REYP2</i>	w/r	0..10	Kind of archiving – number of the register releasing the conditional archiving.	
				Value	Description
				0	Continuous archiving
				1	The value of the first read out register decides about the archiving beginning. If the read out value does not fit in the range definite by <i>dOPrL</i> and <i>dOPrH</i> , the archiving with period follows.
				2	The value of the second read out register decides about the archiving beginning.
				3	The value of the third read out register decides about the archiving beginning.
				4	The value of the fourth read out register decides about the archiving beginning.
				5	The value of the fifth read out register decides about the archiving beginning.
				6	The value of the sixth read out register decides about the archiving beginning.
				7	The value of the seventh read out register decides about the archiving beginning.
8	The value of the eighth read out register decides about the archiving beginning.				

				9	The value of the ninth read out register decides about the archiving beginning.	
				10	The value of the tenth read out register decides about the archiving beginning.	
Device number 3						
4324	<i>Addr3</i>	w/r	0...247	Device address number 3. The write of value 0 switches the readout and archiving off from the given device.		
4325	<i>r_bR3</i>	w/r	0...65535	Basic address – address which the readout will follow from.		
4326	<i>r_no3</i>	w/r	1..10	Number of read out registers from the device or number of data in case of float registers located in two 16-bit registers.		
4327	<i>r_tYP3</i>	w/r	0...25	Type of being read out register:		
				Value	Description	
				The same data as for register 4303		
4328	<i>rFr93</i>	w/r	1..60	Scanning period (data readout) from the device, expressed in seconds.		
4329	<i>RrEE3</i>	w/r	0..1023	Registers are defined on successive bits, which have to be archived. So, bit 0 defines that the first read out register has to be archived. Bit 1 means that the second register has to be archived, etc.		
4330	<i>RFr93</i>	w/r	1..360	The archiving period expressed in tens of a second, determines every which period, data have to be stored in the memory.		

4331	РtYПЗ	w/r	0..10	Kind of archiving – number of the register releasing the conditional archiving.	
				Value	Description
				0	Continuous archiving
				1	The value of the first read out register decides about the archiving beginning. If the read out value does not fit in the range definite by dOP_{rL} and dOP_{rH} , the archiving with period follows.
				2	The value of the second read out register decides about the archiving beginning.
				3	The value of the third read out register decides about the archiving beginning.
				4	The value of the fourth read out register decides about the archiving beginning.
				5	The value of the fifth read out register decides about the archiving beginning.
				6	The value of the sixth read out register decides about the archiving beginning.
				7	The value of the seventh read out register decides about the archiving beginning.
				8	The value of the eighth read out register decides about the archiving beginning.
9	The value of the ninth read out register decides about the archiving beginning.				
10	The value of the tenth read out register decides about the archiving beginning.				

Device number 4					
4332	<i>Addr4</i>	w/r	0..247	Device address number 4. The write of value 0 switches the readout and archiving from the given device off.	
4333	<i>r_bR4</i>	w/r	0...65535	Basic address – address which the readout will follow from.	
4334	<i>r_no4</i>	w/r	1..10	Number of read out registers from the device or number of data in case of float registers located in two 16-bit registers.	
4335	<i>r_tYP4</i>	w/r	0..25	Type of being read out register:	
				Value	Description
				The same data as for register 4303	
4336	<i>rFr94</i>	w/r	1..60	Scanning period (data readout) from the device, expressed in seconds.	
4337	<i>RrEB4</i>	w/r	0..1023	Registers are defined on successive bits, which have to be archived. So, bit 0 defines that the first read out register has to be archived. Bit 1 means that the second register has to be archived, etc.	
4338	<i>RFr94</i>	w/r	1..360	The archiving period expressed in tens of a second, determines every which period, data have to be stored in the memory.	
4339	<i>RtYP4</i>	w/r	0..10	Kind of archiving – number of the register releasing the conditional archiving.	
				Value	Description
				0	Continuous archiving
1	The value of the first read out register decides about the archiving beginning. If the read out value does not fit in the range definite by d0PrL and d0PrH, the archiving with period follows.				

				2	The value of the second read out register decides about the archiving beginning.
				3	The value of the third read out register decides about the archiving beginning.
				4	The value of the fourth read out register decides about the archiving beginning.
				5	The value of the fifth read out register decides about the archiving beginning.
				6	The value of the sixth read out register decides about the archiving beginning.
				7	The value of the seventh read out register decides about the archiving beginning.
				8	The value of the eighth read out register decides about the archiving beginning.
				9	The value of the ninth read out register decides about the archiving beginning.
				10	The value of the tenth read out register decides about the archiving beginning.

Device number 5

4340	<i>Rddr5</i>	w/r	0...247	Device address number 5. The write of value 0 switches the readout and archiving from the given device off.
4341	<i>r_bR5</i>	w/r	0...65535	Basic address – address from which the readout will follow.
4342	<i>r_no5</i>	w/r	1..10	Number of read out registers from the device or number of data in case of float registers located in two 16-bit registers.

4343	<i>rLYP5</i>	w/r	0..25	Type of being read out register:	
				Value	Description
				The same data as for register 4303	
4344	<i>rFr95</i>	w/r	1..60	Scanning period (data readout) from the device, expressed in seconds.	
4345	<i>RrEE5</i>	w/r	0..1023	Registers are defined on successive bits, which have to be archived. So, bit 0 defines that the first read out register has to be archived. Bit 1 means that the second register has to be archived, etc.	
4346	<i>RFr95</i>	w/r	1..360	The archiving period expressed in tens of a second, determines every which period, data have to be stored in the memory.	
4347	<i>RLYP5</i>	w/r	0..10	Kind of archiving – number of the register releasing the conditional archiving.	
				Value	Description
				0	Continuous archiving
				1	The value of the first read out register decides about the archiving beginning. If the read out value does not fit in the range definite by <i>dOP-L</i> and <i>dOP-H</i> , the archiving with period follows.
				2	The value of the second read out register decides about the archiving beginning.
				3	The value of the third read out register decides about the archiving beginning.
4	The value of the fourth read out register decides about the archiving beginning.				

				5	The value of the fifth read out register decides about the archiving beginning.
				6	The value of the sixth read out register decides about the archiving beginning.
				7	The value of the seventh read out register decides about the archiving beginning.
				8	The value of the eighth read out register decides about the archiving beginning.
				9	The value of the ninth read out register decides about the archiving beginning.
				10	The value of the tenth read out register decides about the archiving beginning.
Device number 6					
4348	<i>Addr6</i>	w/r	0...247	Device address number 6. The write of value 0 switches the readout and archiving from the given device off.	
4349	<i>r_bA6</i>	w/r	0...65535	Basic address – address from which the readout will follow.	
4350	<i>r_no6</i>	w/r	1..10	Number of read out registers from the device or number of data in case of float registers located in two 16-bit registers.	
4351	<i>r_tYP6</i>	w/r	0...25	Type of being read out register:	
				Value	Description
				The same data as for register 4303	
4352	<i>rFr96</i>	w/r	1..60	Scanning period (data readout) from the device, expressed in seconds.	
4353	<i>ArE66</i>	w/r	0..1023	Registers are defined on successive bits, which have to be archived. So, bit 0 defines that the first read out register has to be archived. Bit 1 means that the second register has to be archived, etc.	

4354	RF-96	w/r	1..360	The archiving period expressed in tens of a second, determines every which period, data have to be stored in the memory.	
4355	REYP6	w/r	0..10	Kind of archiving – number of the register releasing the conditional archiving.	
				Value	Description
				0	Continuous archiving
				1	The value of the first read out register decides about the archiving beginning. If the read out value does not fit in the range definite by dOP_{rL} and dOP_{rH} , the archiving with period follows.
				2	The value of the second read out register decides about the archiving beginning.
				3	The value of the third read out register decides about the archiving beginning.
				4	The value of the fourth read out register decides about the archiving beginning.
				5	The value of the fifth read out register decides about the archiving beginning.
				6	The value of the sixth read out register decides about the archiving beginning.
				7	The value of the seventh read out register decides about the archiving beginning.
8	The value of the eighth read out register decides about the archiving beginning.				

				9	The value of the ninth read out register decides about the archiving beginning.
				10	The value of the tenth read out register decides about the archiving beginning.
Device number 7					
4356	<i>Addr7</i>	w/r	0...247	Device address number 7. The write of value 0 switches the readout and archiving from the given device off.	
4357	<i>r_bA7</i>	w/r	0...65535	Basic address – address from which the readout will follow.	
4358	<i>r_no7</i>	w/r	1..10	Number of read out registers from the device or number of data in case of float registers located in two 16-bit registers.	
4359	<i>r_tYP7</i>	w/r	0...25	Type of being read out register:	
				Value	Description
				The same data as for register 4303	
4360	<i>rFr97</i>	w/r	1..60	Scanning period (data readout) from the device, expressed in seconds.	
4361	<i>RE67</i>	w/r	0..1023	Registers are defined on successive bits, which have to be archived. So, bit 0 defines that the first read out register has to be archived. Bit 1 means that the second register has to be archived, etc.	
4362	<i>RFr97</i>	w/r	1..360	The archiving period expressed in tens of a second, determines every which period, data have to be stored in the memory.	

4363	RŁYP7	w/r	0..10	Kind of archiving – number of the register releasing the conditional archiving.	
				Value	Description
				0	Continuous archiving
				1	The value of the first read out register decides about the archiving beginning. If the read out value does not fit in the range definite by $dOP-L$ and $dOP-H$, the archiving with period follows.
				2	The value of the second read out register decides about the archiving beginning.
				3	The value of the third read out register decides about the archiving beginning.
				4	The value of the fourth read out register decides about the archiving beginning.
				5	The value of the fifth read out register decides about the archiving beginning.
				6	The value of the sixth read out register decides about the archiving beginning.
				7	The value of the seventh read out register decides about the archiving beginning
				8	The value of the eighth read out register decides about the archiving beginning.
9	The value of the ninth read out register decides about the archiving beginning.				

				10	The value of the tenth read out register decides about the archiving beginning.
Device number 8					
4364	<i>AddrB</i>	w/r	0...247	Device address number 8. The write of value 0 switches the readout and archiving from the given device off.	
4365	<i>r_bAB</i>	w/r	0...65535	Basic address – address from which the readout will follow.	
4366	<i>r_noB</i>	w/r	1..10	Number of read out registers from the device or number of data in case of float registers located in two 16-bit registers.	
4367	<i>r_tYPB</i>	w/r	0...25	Type of being read out register:	
				Value	Description
				The same data as for register 4303	
4368	<i>rFrPB</i>	w/r	1..60	Scanning period (data readout) from the device, expressed in seconds.	
4369	<i>REEB</i>	w/r	0..1023	Registers are defined on successive bits, which have to be archived. So, bit 0 defines that the first read out register has to be archived. Bit 1 means that the second register has to be archived, etc.	
4370	<i>AFrPB</i>	w/r	1..360	The archiving period expressed in tens of a second, determines every which period, data have to be stored in the memory.	
4371	<i>REYPB</i>	w/r	0..10	Kind of archiving – number of the register releasing the conditional archiving.	
				Value	Description
				0	Continuous archiving
				1	The value of the first read out register decides about the archiving beginning. If the read out value does not fit in the range definite by d0PrL and d0PrH, the archiving with period follows.

				2	The value of the second read out register decides about the archiving beginning.
				3	The value of the third read out register decides about the archiving beginning.
				4	The value of the fourth read out register decides about the archiving beginning.
				5	The value of the fifth read out register decides about the archiving beginning.
				6	The value of the sixth read out register decides about the archiving beginning.
				7	The value of the seventh read out register decides about the archiving beginning.
				8	The value of the eighth read out register decides about the archiving beginning.
				9	The value of the ninth read out register decides about the archiving beginning.
				10	The value of the tenth read out register decides about the archiving beginning.
Device number 9					
4372	<i>Addr9</i>	w/r	0...247	Device address number 9. The write of value 0 switches the readout and archiving from the given device off.	
4373	<i>r_bA9</i>	w/r	0...65535	Basic address – address from which the readout will follow.	
4374	<i>r_no9</i>	w/r	1..10	Number of read out registers from the device or number of data in case of float registers located in two 16-bit registers.	

4375	<i>rEYP9</i>	w/r	0...25	Type of being read out register:	
				Value	Description
				The same data as for register 4303	
4376	<i>rFr99</i>	w/r	1..60	Scanning period (data readout) from the device, expressed in seconds.	
4377	<i>RrE69</i>	w/r	0..1023	Registers are defined on successive bits, which have to be archived. So, bit 0 defines that the first read out register has to be archived. Bit 1 means that the second register has to be archived, etc.	
4378	<i>RFr99</i>	w/r	1..360	The archiving period expressed in tens of a second, determines every which period, data have to be stored in the memory.	
4379	<i>RrEYP9</i>	w/r	0..10	Kind of archiving – number of the register releasing the conditional archiving.	
				Value	Description
				0	Continuous archiving
				1	The value of the first read out register decides about the archiving beginning. If the read out value does not fit in the range definite by dDP_{rL} and dDP_{rH} , the archiving with period follows.
				2	The value of the second read out register decides about the archiving beginning.
				3	The value of the third read out register decides about the archiving beginning.
4	The value of the fourth read out register decides about the archiving beginning.				

				5	The value of the fifth read out register decides about the archiving beginning.
				6	The value of the sixth read out register decides about the archiving beginning.
				7	The value of the seventh read out register decides about the archiving beginning
				8	The value of the eighth read out register decides about the archiving beginning.
				9	The value of the ninth read out register decides about the archiving beginning.
				10	The value of the tenth read out register decides about the archiving beginning

Table 13

The value is located in 16-bit registers	write (w)/readout (r)	Range	Description
4500	z/o	0..8191	Number of the memory page to which we want to obtain the access.
4501	o	0...65535	Two first data bytes from the page indicated by the register 4500.
4502	o	0...65535	Two successive bytes.
---	---	---	---
4764	o	0...65535	Two last bytes of the memory page (bytes 526 and 527).

Table 14

The value is located in two successive 16-bit registers. These registers include the same data as 32-bit registers from the area 7600	The value is located in 32-bit registers	Symbol	write (w) / readout (r)	range	Description
6200/7200	7600	CoLLo	w/r	-19999...99999	Lower threshold of the display colour change
6202/7202	7601	CoLHi	w/r	-19999...99999	Upper threshold of the display colour change
6204/7204	7602	ourLo	w/r	-19999...99999	Lower threshold of the display narrowing
6206/7206	7603	ourHi	w/r	-19999...99999	Upper threshold of the display narrowing
6208/7208	7604	PrL_1	w/r	-19999...99999	Lower display of alarm 1 (Aoff)
6210/7210	7605	PrH_1	w/r	-19999...99999	Upper display of alarm 1 (Aon)
6212/7212	7606	PrL_2	w/r	-19999...99999	Lower display of alarm 2 (Aoff)
6214/7214	7607	PrH_2	w/r	-19999...99999	Upper display of alarm 2 (Aon)

6216/7216	7608	<i>P_{rL3}</i>	w/r	-19999...99999	Lower display of alarm 3 (Aoff)
6218/7218	7609	<i>P_{rH3}</i>	w/r	-19999...99999	Upper display of alarm 3 (Aon)
6220/7220	7610	<i>P_{rL4}</i>	w/r	-19999...99999	Lower display of alarm 4 (Aoff)
6222/7222	7611	<i>P_{rH4}</i>	w/r	-19999...99999	Upper display of alarm 4 (Aon)
6224/7224	7612	<i>A_{nLo}</i>	w/r	-19999...99999	Lower display of the analog output
6226/7226	7613	<i>A_{nHi}</i>	w/r	-19999...99999	Upper display of the analog output
...	Reserved
6244/7244	7622	<i>H1</i>	w/r	-19999...99999	Point of the individual characteristic. Point No 1
6246/7246	7623	<i>Y1</i>	w/r	-19999...99999	Expected value for the point No 1
6248/7248	7624	<i>H2</i>	w/r	-19999...99999	Point of the individual characteristic. Point No 2
6250/7250	7625	<i>Y2</i>	w/r	-19999...99999	Expected value for the point No 2
6252/7252	7626	<i>H3</i>	w/r	-19999...99999	Point of the individual characteristic. Point No 3
6254/7254	7627	<i>Y3</i>	w/r	-19999...99999	Expected value for the point No 3
6256/7256	7628	<i>H4</i>	w/r	-19999...99999	Point of the individual characteristic. Point No 4
6258/7258	7629	<i>Y4</i>	w/r	-19999...99999	Expected value for the point No 4

6260/7260	7630	H5	w/r	-19999...99999	Point of the individual characteristic. Point No 5
6262/7262	7631	У5	w/r	-19999...99999	Expected value for the point No 5
6264/7264	7632	H6	w/r	-19999...99999	Point of the individual characteristic. Point No 6
6266/7266	7633	У6	w/r	-19999...99999	Expected value for the point No 6
6268/7268	7634	H7	w/r	-19999...99999	Point of the individual characteristic. Point No 7
6270/7270	7635	У7	w/r	-19999...99999	Expected value for the point No 7
6272/7272	7636	H8	w/r	-19999...99999	Point of the individual characteristic. Point No 8
6274/7274	7637	У8	w/r	-19999...99999	Expected value for the point No 8
6276/7276	7638	H9	w/r	-19999...99999	Point of the individual characteristic. Point No 9
6278/7278	7639	У9	w/r	-19999...99999	Expected value for the point No 9
6280/7280	7640	H 10	w/r	-19999...99999	Point of the individual characteristic. Point No 10
6282/7282	7641	У 10	w/r	-19999...99999	Expected value for the point No 10
6284/7284	7642	H 11	w/r	-19999...99999	Point of the individual characteristic. Point No 11
6286/7286	7643	У 11	w/r	-19999...99999	Expected value for the point No 11

6288/7288	7644	H 12	w/r	-19999...99999	Point of the individual characteristic. Point No 12
6290/7290	7645	Y 12	w/r	-19999...99999	Expected value for the point No 12
6292/7292	7646	H 13	w/r	-19999...99999	Point of the individual characteristic. Point No 13
6294/7294	7647	Y 13	w/r	-19999...99999	Expected value for the point No 13
6296/7296	7648	H 14	w/r	-19999...99999	Point of the individual characteristic. Point No 14
6298/7298	7649	Y 14	w/r	-19999...99999	Expected value for the point No 14
6300/7300	7650	H 15	w/r	-19999...99999	Point of the individual characteristic. Point No 15
6302/7302	7651	H 15	w/r	-19999...99999	Expected value for the point No 15
6304/7304	7652	H 15	w/r	-19999...99999	Point of the individual characteristic. Point No 16
6306/7306	7653	Y 15	w/r	-19999...99999	Expected value for the point No 16
6308/7308	7654	H 17	w/r	-19999...99999	Point of the individual characteristic. Point No 17
6310/7310	7655	Y 17	w/r	-19999...99999	Expected value for the point No 17
6312/7312	7656	H 18	w/r	-19999...99999	Point of the individual characteristic. Point No 18
6314/7314	7657	Y 18	w/r	-19999...99999	Expected value for the point No 18

6316/7316	7658	H_{19}	w/r	-19999...99999	Point of the individual characteristic. Point No 19
6318/7318	7659	Y_{19}	w/r	-19999...99999	Expected value for the point No 19
6320/7320	7660	H_{20}	w/r	-19999...99999	Point of the individual characteristic. Point No 20
6322/7322	7661	H_{20}	w/r	-19999...99999	Expected value for the point No 20
6324/7324	7662	H_{21}	w/r	-19999...99999	Point of the individual characteristic. Point No 21
6326/7326	7663	Y_{21}	w/r	-19999...99999	Expected value for the point No 21
6328/7328	7664	dOP_{rL}	w/r	-19999...99999	Lower value of the conditional archiving threshold for the device number 0
6330/7330	7665	dOP_{rH}	w/r	-19999...99999	Upper value of the conditional archiving threshold for the device number 0
6332/7332	7666	dIP_{rL}	w/r	-19999...99999	Lower value of the conditional archiving threshold for the device number 1
6334/7334	7667	dIP_{rH}	w/r	-19999...99999	Upper value of the conditional archiving threshold for the device number 1
6336/7336	7668	$d2P_{rL}$	w/r	-19999...99999	Lower value of the conditional archiving threshold for the device number 2

6338/7338	7669	d2P _r H	w/r	-19999...99999	Upper value of the conditional archiving threshold for the device number 2
6340/7340	7670	d3P _r L	w/r	-19999...99999	Lower value of the conditional archiving threshold for the device number 3
6342/7342	7671	d3P _r H	w/r	-19999...99999	Upper value of the conditional archiving threshold for the device number 3
6344/7344	7672	d4P _r L	w/r	-19999...99999	Lower value of the conditional archiving threshold for the device number 4
6346/7346	7673	d4P _r H	w/r	-19999...99999	Upper value of the conditional archiving threshold for the device number 4
6348/7348	7674	d5P _r L	w/r	-19999...99999	Lower value of the conditional archiving threshold for the device number 5
6350/7350	7675	d5P _r H	w/r	-19999...99999	Upper value of the conditional archiving threshold for the device number 5
6352/7352	7676	d6P _r L	w/r	-19999...99999	Lower value of the conditional archiving threshold for the device number 6
6354/7354	7677	d6P _r H	w/r	-19999...99999	Upper value of the conditional archiving threshold for the device number 6

6356/7356	7678	d7P _{rL}	w/r	-19999...99999	Lower value of the conditional archiving threshold for the device number 7
6358/7358	7679	d7P _{rH}	w/r	-19999...99999	Upper value of the conditional archiving threshold for the device number 7
6360/7360	7680	d8P _{rL}	w/r	-19999...99999	Lower value of the conditional archiving threshold for the device number 8
6362/7362	7681	d8P _{rH}	w/r	-19999...99999	Upper value of the conditional archiving threshold for the device number 8
6364/7364	7682	d9P _{rL}	w/r	-19999...99999	Lower value of the conditional archiving threshold for the device number 9
6366/7366	7683	d9P _{rH}	w/r	-19999...99999	Upper value of the conditional archiving threshold for the device number 9

8.6 Registers Only for Readout

Table 15

The value is located in two successive 16-bit registers. These registers include the same data as 32-bit registers from the area 7500	The value is located in 32-bit registers	Name	write (w) / readout (r)	Unit	Description
6000/7000	7500	Identifier	r	—	Constant identifying the device. Value 181 means the N30B recorder
6002/7002	7501	Status	r	—	Status is the register describing the current recorder state
6004/7004	7502	Control	r	%	This is the register defining the analog output control
6006/7006	7503	Minimum	r	—	Minimal value of currently displayed value
6008/7008	7504	Maksimum	r	—	Maximal value of currently displayed value
6010/7010	7505	Displayed value	r	—	Currently displayed value
6012/7012	7506	Current time	r	—	Current time
6014/7014	7507	Current date and time	r	—	Year in YYYY format.

6016/7016	7508	Current date month and date	r	—	Month and day in MM,DD format
6018/7018	7509	Filling of archive memory	r	%	Filling degree of the archive memory
6020/7020	7510		r		Measured value – not recounted in relation to the individual characteristic
...
6040/7040	7520	—	r	%	Communication correctness with the device number 0, expressed in percentage.
6042/7042	7521		r	%	Communication correctness with the device number 1, expressed in percentage.
6044/7044	7522		r	%	Communication correctness with the device number 2, expressed in percentage.
6046/7046	7523		r	%	Communication correctness with the device number 3, expressed in percentage.
6048/7048	7524		r	%	Communication correctness with the device number 4 expressed in percentage.
6050/7050	7525		r	%	Communication correctness with the device number 5, expressed in percentage.
6052/7052	7526		r	%	Communication correctness with the device number 6, expressed in percentage.

6054/7054	7527		r	%	Communication correctness with the device number 7, expressed in percentage.
6056/7056	7528		r	%	Communication correctness with the device number 8, expressed in percentage.
6058/7058	7529		r	%	Communication correctness with the device number 9, expressed in percentage.
6060/7060	7530		r	—	Number of transmissions with the device number 0.
6062/7062	7531		r	—	Number of transmissions with the device number 1.
6064/7064	7532		r	—	Number of transmissions with the device number 2.
6066/7066	7533		r	—	Number of transmissions with the device number 3.
6068/7068	7534		r	—	Number of transmissions with the device number 4.
6070/7070	7535		r	—	Number of transmissions with the device number 5.
6072/7072	7536		r	—	Number of transmissions with the device number 6.
6074/7074	7537		r	—	Number of transmissions with the device number 7.
6076/7076	7538		r	—	Number of transmissions with the device number 8.

6078/7078	7539		r	—	Number of transmissions with the device number 9.
6080/7080	7540		r	—	Number of erroneous communications with the device number 0.
6082/7082	7541		r	—	Number of erroneous communications with the device number 1.
6084/7084	7542		r	—	Number of erroneous communications with the device number 2.
6086/7086	7543		r	—	Number of erroneous communications with the device number 3.
6088/7088	7544		r	—	Number of erroneous communications with the device number 4.
6090/7090	7545		r	—	Number of erroneous communications with the device number 5.
6092/7092	7546		r	—	Number of erroneous communications with the device number 6.
6094/7094	7547		r	—	Number of erroneous communications with the device number 7.
6096/7096	7548		r	—	Number of erroneous communications with the device number 8.
6098/7098	7549		r	—	Number of erroneous communications with the device number 9.

Note: The contents of registers 7520..7549 (and their equivalents) is zeroed after the supply decay.

8.7 Registers of Values for Readout and Write

Values located in registers can be always read out. The write in registers is only possible in the slave mode - *ALTYPE* parameter.

Table 16

The value is located in two successive 16-bit registers. These registers include the same data as 32-bit registers from the area 8000	The value is located in 32-bit registers	Name	write (w) / readout (r)	Unit	Quantity name
8400/8200	8000	Device 0 register 1	w/r	—	Device 0 – first read out register
...
8418/8218	8009	Device 0 register 10	w/r	—	Device 0 – tenth read out register
8420/8220	8010	Device 1 register 1	w/r	—	Device 1 – first read out register
...
8438/8238	8019	Device 1 register 10	w/r	—	Device 1 – tenth read out register
8440/8240	8020	Device 2 register 1	w/r	—	Device 2 – first read out register

...
8458/8258	8029	Device 2 register 10	w/r	—	Device 2 – tenth read out register
8460/8260	8030	Device 3 register 1	w/r	—	Device 3 – first read out register
...
8478/8278	8039	Device 3 register 10	w/r	—	Device 3 – tenth read out register
8480/8280	8040	Device 4 register 1	w/r	—	Device 2 – first read out register
...
8498/8298	8049	Device 4 register 10	w/r	—	Device 4 – tenth read out register
8500/8300	8050	Device 5 register 1	w/r	—	Device 5 – first read out register
...
8518/8318	8059	Device 5 register 10	w/r	—	Device 5 – tenth read out register
8520/8320	8060	Device 6 register 1	w/r	—	Device 6 – first read out register
...
8538/8338	8069	Device 6 register 10	w/r	—	Device 6 – tenth read out register
8540/8340	8070	Device 7 register 1	w/r	—	Device 7 – first read out register
...
8558/8358	8079	Device 7 register 10	w/r	—	Device 7 – tenth read out register



8560/8360	8080	Device 8 register 1	w/r	—	Device 8 – first read out register
...
8578/8378	8089	Device 8 register 10	w/r	—	Device 8 – tenth read out register
8580/8380	8090	Device 9 register 1	w/r	—	Device 9 – first read out register
...
8598/8398	8099	Device 9 register 10	w/r	—	Device 9 – tenth read out register

9. ERROR CODES

After switching the recorder on or during the work, messages about errors can appear.

Messages about errors and their reasons are presented below.

Table 17

Error message	Description
	Overflow of upper value of the measuring range value or communication error with the co-operating device.
	Overflow of lower value of the programmed indication range
	No communication with the device.
<i>FULL</i>	The memory card is filled. One must replace it by a new one.
<i>ErFrt</i>	Communication error with the data memory. One must contact the service workshop.
<i>ErPRr</i>	Parameter error. Wrong configuration data. Manufacturer's settings will be restored after pressing any push-button.
<i>ErDEF</i>	Default settings have been restored. One must press any push-button to transit to a normal work.
<i>ErFPL</i>	Error of measured values stored by the recorder (measured value, maximal value and minimal value). One must press any push-button to transit to the normal work. After pressing the push-button, the <i>ErDEF</i> message will be displayed during one second.

<i>E_rCAO</i>	Error of analog output calibration. One must press any push-button to transit to the normal work. Analog outputs will not be serviced. One must contact the Service Department.
<i>E_rAPL</i>	Configuration error of archive parameters – data have been lost.
<i>E_rDFC</i>	Communication error with the internal archive memory.

10. TECHNICAL DATA

Relay outputs:

- relays, NOC voltageless contacts load capacity 250 V~/0.5 A~
- relays, switching over voltageless contacts load capacity 250 V~/0.5 A~

Analog outputs (option):

- programmable, current 0/4..20 mA
load resistance $\leq 500 \Omega$
- programmable, voltage 0..10 V
load resistance $\geq 500 \Omega$

Alarm OC output (option):

output of OC type, passive npn, 30 V d.c./30 mA.

Serial interface port 1 and 2: address 1..247
mode: 8N2, 8E1, 8O1,8N1
baud rate: 4.8, 9.6, 19.2,
38,4, 57,6, 115,2kbit/s
transmission protocol:
Modbus RTU
time to start a response:
200 ms (work without card)
time to start a response:
1000 ms (work with card)

Archive memory card: SD, MMC

Error of analog output: 0.2% of the set range

Protection grade ensured by the casing:
frontal side IP65
terminal side IP10

Weight: < 0.2 kg

Overall dimensions: 96 x 48 x 93 mm

Reference Conditions and Rated Operating Conditions

- supply voltage 85 .. 253V a.c.
(40..400Hz); 90 .. 320V d.c.
or 20 .. 40V a.c.
(40..400Hz); 20 .. 60V d.c.
- ambient temperature -25..23..+55°C
- storage temperature -30..+70°C
- relative air humidity 25..95 % (inadmissible
condensation)

- external magnetic field 0..40..400 A/m
- work position any
- power consumption < 6 VA

Additional errors:

- from temperature changes
for analog outputs: 50% of the class / 10 K

Standards fulfilled by the recorder:

Electromagnetic compatibility:

- noise immunity acc. to EN 61000-6-2
- noise emissions acc. to EN 61000-6-4

Safety requirements:

Acc. to standard EN61010-1

- isolation between circuits: basic,
- installation category: III,
- pollution level: 2,
- maximal phase-to-earth working voltage:
300V for the supply circuit
and 50 V for remaining circuits,
- altitude above sea level < 2000 m.

11. ORDER CODES

Order codes for the N30B recorder

Table 18

Digital panel recorder N30B	X	X	XX	XX	X	X
Supply voltage:						
85...253 V a.c. (40 ... 400 Hz); 90 ... 320 V d.c.	1					
20...40 V a.c. (40 ... 400 Hz); 20 ... 60 V d.c.	2					
Additional outputs:						
lack	0					
OC output, RS485, analog outputs	1					
OC output, RS485, analog outputs, switched relay outputs,	2					
Unit:						
unit code number acc to tab. 19			XX			
Version:						
standar				00		
custom-made*				XX		
Language:						
Polish					P	
English					E	
other*					X	
Acceptance tests:						
Without extra quality requirements						0
With an extra quality inspection certificate						1

* - After agreeing with the manufacturer,

Table 19

Code	Unit	Code	Unit	Code	Unit
00	lack of unit	20	kVAh	40	szt
01	V	21	MVAh	41	imp
02	A	22	Hz	42	rps
03	mV	23	kHz	43	m/s
04	kV	24	Ω	44	l/s
05	mA	25	k Ω	45	obr/min
06	kA	26	$^{\circ}\text{C}$	46	rpm
07	W	27	$^{\circ}\text{F}$	47	mm/min
08	kW	28	K	48	m/min
09	MW	29	%	49	l/min
10	var	30	%RH	50	m ³ /min
11	kvar	31	pH	51	szt/h
12	Mvar	32	kg	52	m/h
13	VA	33	bar	53	km/h
14	kVA	34	m	54	m ³ /h
15	MVA	35	l	55	kg/h
16	kWh	36	s	56	l/h
17	MWh	37	h	XX	on order*
18	kvarh	38	m ³		
19	Mvarh	39	obr		

* - After agreeing with the manufacturer.

ORDER EXAMPLE:

the code: **N30B 102900E8** means:

N30B – programmable digital recorder type,

1 – supply: 85...253 V a.c. (40...400 Hz),

0 – lack of additional outputs,

29 – unit „%” acc. to the table 16,

00 – standard option,

E – English language

8 – without extra quality requirements.

12. MAINTENANCE AND GUARANTEE

The N30B digital panel recorder does not require any periodical maintenance.

In case of some incorrect operations:

1. From the shipping date, during the period given in the annexed guarantee card:

One should take the recorder down from the installation and return it to the Manufacturer's Quality Control Dept.

If the recorder has been used in compliance with the instructions, the Manufacturer warrants to repair it free of charge.

2. After the Guarantee Period:

One should turn over the recorder to repair it in a certified service workshop.

The disassembly of the housing causes the cancellation of the granted guarantee.

Our policy is one of continuous improvement and we reserve the right to make changes in design and specifications of any products as engineering advances or necessity requires and revise the above specifications without notice.



Sifam Tinsley Instrumentation Ltd

Unit 1 Warner Drive,
Springwood Industrial Estate
Braintree, Essex, UK, CM72YW
E-mail: sales@sifamtinsley.com
Web: www.sifamtinsley.com/uk
Contact: +44(0)1803615139

Sifam Tinsley Instrumentation Inc.

3105, Creekside Village Drive,
Suite No. 801, Kennesaw,
Georgia 30144 (USA)
E-mail Id : psk@sifamtinsley.com
Web: www.sifamtinsley.com
Contact No.: +1 404 736 4903

N30B-09A