

P30H TRANSUCER OF D.C. CIRCUITS PARAMETERS WITH DATA RECORD AND ETHERNET

FEATURES:

- MOD BUS Slave
- MOD BUS Master
- MOD BUS Monitor
- eCon Program
- SD/SDHC
- Firmware upgrade
- RTC
- Password protection
- Ethernet
- www ftp
- CAN
- CAN open

INPUT:

- DC
- MOD BUS
- RS 485

OUTPUTS:

- Graph
- Relay
- U
- RS 485
- CAN

GALVANIC ISOLATION:

- Supply
- RS 485
- Ethernet

Export department:
+48 68 45 75 138/ 233/
321/ 586
Fax: +48 68 32 54 091
e-mail: export@lumel.com.pl

LUMEL S.A.
ul. Sulechowska 1
65-022 Zielona Góra
POLAND
WWW.LUMEL.COM.PL



- Measurement of voltage, current, power, energy and other parameters in d.c. circuits.
- Conversion of measured value in an output signal on the base of the individual characteristic.
- 1 or 2 alarm relays with NO contact working in 6 modes.
- Additional supplying output 24 V d.c 30 mA switched-on/switched-off (option).
- Recording of input signals in internal memory, on SD/SDHC card (option) or internal file system memory (option).
- Interface RS-485 Modbus RTU.
- RS-485 Master/Monitor mode – possibility to poll 1 device.
- SD/SDHC support (option).
- Interface Ethernet 10/100 BASE-T (option).
- Protocol: Modbus TCP/IP, HTTP, FTP.
- Services: www server, ftp server, client DHCP.
- Interface CAN with CANopen protocol.

EXAMPLE OF APPLICATION

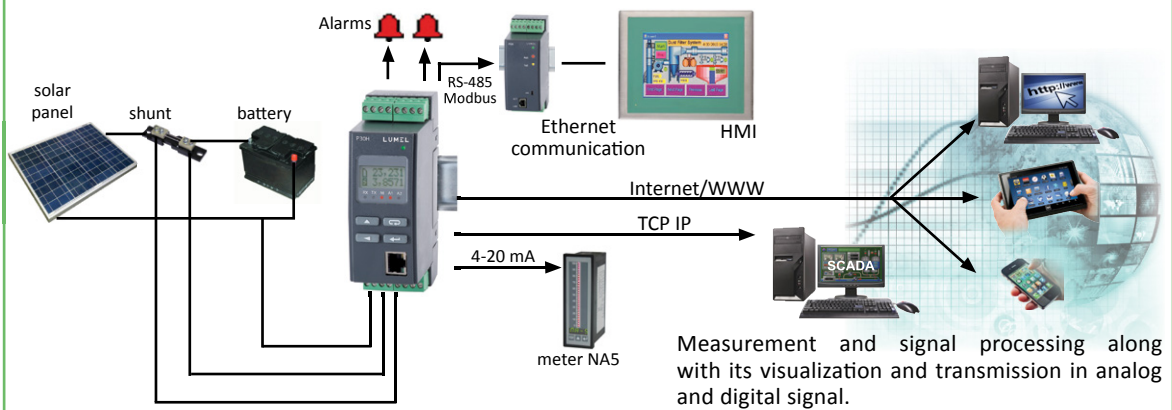

MEASURED AND CALCULATED VALUES BY THE TRANSUCER

- d.c. voltage U (direct or through additional resistor D5)
- d.c. current I (direct through shunt)
- power of d.c. current P
- voltage difference in time dU (5 s, 30 s, 1 min, 5 min or 15 min)
- current difference in time dI (5 s, 30 s, 1 min, 5 min or 15 min)
- voltage averaged over time U_{AV} (15, 30 or 60 min.)
- current averaged over time I_{AV} (15, 30 or 60 min.)
- power averaged over time P_{AV} (15, 30 or 60 min.)
- operating/ measurement time $t [s]$
- operating/ measurement time $t [H.M]$
- load capacity C
- input energy $E_{p \leftarrow}$
- output energy $E_{p \rightarrow}$
- total energy E_p (input+output)
- maximum and minimum values

INPUTS AND MEASURING RANGES

Measured value		Nominal range $K_U=1, K_I=100\ 000$	Measuring range (maximum)	Class
Voltages U, dU, U_{AV}	12V	-4 ... 12 V	-5...15 V	0.2
	48V	-4 ... 48 V	-10...57.6 V	
	100V	-5 ... 100 V	-10...120 V	
	250V	-5 ... 250 V	-10 ... 300V	
	600V*	-10 ... 500 V	-10...600 V	
	1000V*	-10 ... 1000 V	-10...1000 V	0.2 + class of additional resistor
Currents (shunt voltage) I, dI, I_{AV}		-15000 ... 15000 A (-150 ... 150 mV)	-18000 ... 18000 A (-180 ... 180 mV)	0.2+ shunt class (voltage measurement 0.2)
Time counter $t [s]$ $t [H. M]$		0...999999999 s 0...277777.5 h.m		1s/ 24h, resolution 1 s
Capacity C		-49 999 999 ... 49 999 999 kWh		$\pm 0.5 \%$
Power P, P_{AV}	12V	-60...180 kW	-75...225 kW	0.4 + shunt class
	48V	-60...720 kW	-150...864 kW	
	100V	-0,075...1,5 MW	-0,15...1,8 MW	
	250V	-0,075...3,75 MW	-0,15...4,5 MW	
	600V*	-0,15...7,5 MW	-0,3...9 MW	
	1000V*	-0,3...15 MW	-0,6...18 MW	0.4 + shunt class + + class of additional resistor
Input energy $E_{p \leftarrow}$ Output energy $E_{p \rightarrow}$		0 ... 99 999 999.9 kWh		$\pm 0.5 \%$ + shunt class
Energy sum E_p (input and output)		0 ... 199 999 999.9 kWh		$\pm 1 \%$ + shunt class

* - version in set with additional resistor D5 ($K_U \neq 1$),

K_U - voltage ratio (Pri mar. U / Second. U),
 K_I - current ratio (Shunt I / Shunt mV, $K = 100\ 000$ e.g. for shunt 15 000 A/ 150 mV)

The maximum range display of measured values on the LCD display are -99999G ... 99999G. These ranges depend upon the size parameters of the primary and secondary voltage divider and the shunt ratio (parameters Pri mar. U, Second. U, Shunt I, Shunt mV).

OUTPUTS

Output type	Properties	Remarks
Analog OUT1, OUT2 (1 or 2 outputs - depends on transducer version)	OUT1 current: 0/4...20 mA, load resistance \leq 500 Ω voltage: 0...10 V, load resistance \geq 500 Ω	accuracy class 0.1
	OUT2 current: 0/4...20 mA, load resistance \leq 250 Ω voltage: 0...10 V, load resistance \geq 500 Ω	accuracy class 0.5
Relay OUT2,OUT3 (1 or 2 outputs - depends on transducer version)	1 or 2 relays; voltageless contacts – NO –maximum load 5A 30V d.c., 250V a.c.	
Additional supplying output OUT3	24 V d.c. / 30 mA (option)	
Interface CAN OUT2	only for transducer version P30H X00XXXXXX	

DIGITAL INTERFACE

Interface type	Properties	Remarks
Ethernet 10/100 Baste-T (option)	Modbus TCP/ IP HTTP, FTP	www, ftp server, client DHCP
RS-485	Modbus RTU: 8N2, 8E1, 8O1, 8N1 Address 1...247	baud rate: 4.8, 9.6, 19.2, 38.4, 57.6, 115.2, 230.4, 256 kbit/s
CAN	Protocol: CANopen	baud rate: 20, 50, 100, 125, 250, 500, 1000 kBit/s

EXTERNAL FEATURES

Overall dimensions	45 x 120 x 100 mm	
Weight	< 0.25 kg	
Protection grade	for housing: IP40/ IP30	for terminals: IP20
Readout field	LCD 2 x 8 characters with LED backlight	

RATED OPERATION CONDITIONS

Supply voltage	• 85...253 V a.c., 85...300 V d.c. • 20...40 V a.c., 20...60 V d.c.	power consumption < 5 VA
Temperature	ambient: -25...23...+55°C	storage: -30...+70°C
Humidity	25...95 %	inadmissible condensation
Working position	any	

SAFETY AND COMPATIBILITY REQUIREMENTS

Electromagnetic compatibility	noise immunity	acc. to EN 61000-6-2
	noise emissions	acc. to EN 61000-6-4
Isolation between circuits	basic / reinforced (see user's manual)	acc. to EN 61010-1
Pollution level	2	
Installation category	III for input voltage up to 300 V d.c., III for input voltage 300...600 V d.c. with additional resistance D5, II for input voltage 600...1000 V d.c. with additional resistance D5	acc. to EN 61010-1
Maximal phase-to-earth voltage	• for supply and input circuits 300 V • for other circuits 50 V	
Altitude above sea level	< 2000 m	

CONNECTION DIAGRAM

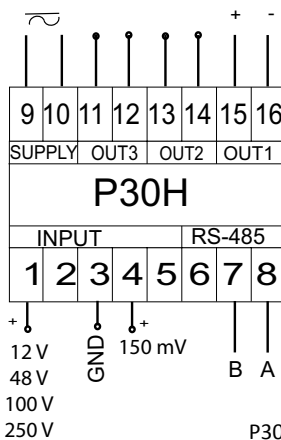

SUPPLY - supply
 OUT2 - output no.2 (alarm. wyj analogowe lub interfejsowe CAN)
 OUT3 - output no.3 (alarm or supplying output 24V)
 OUT1 - main analog output no.1
 INPUT - measuring input
 RS-485 - interface RS-485

P30H-XX11XXXXX

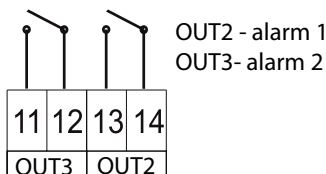

P30H-XX21XXXXX

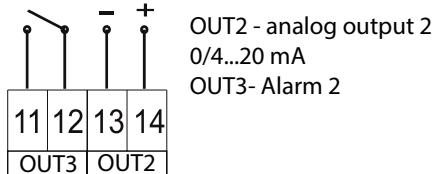

SEE ALSO:



Screen recorder KD8 with touch panel - 3 or 6 channels - RS-485 interface.



Programmable digital meter of temperature, resistance and standard signals N30U.



Software LUMEL - PROCES.

For more information about LUMEL products please visit our website: www.lumel.com.pl

Export department:
 +48 66 45 75 130/ 233/
 321/ 366
 Fax: +48 66 32 54 091
 e-mail: export@lumel.com.pl

LUMEL S.A.
 ul. Sulechowska 1
 65-022 Zielona Góra
 POLAND
WWW.LUMEL.COM.PL

P30H

TRANSDUCER OF D.C. CIRCUITS PARAMETERS WITH DATA RECORD AND ETHERNET

CONNECTION DIAGRAM

SEE ALSO:



Temperature and d.c. standard signals universal digital meter with OLED - N21 type.

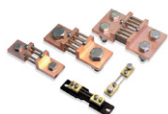

Shunts class 0.5



Analog meters

For more information about LUMEL products please visit our website:
www.lumel.com.pl

Export department:
+48 68 45 75 138/ 233/
321/366
Fax: +48 68 32 54 001
e-mail: export@lumel.com.pl

LUMEL S.A.
ul. Sulechowska 1
65-022 Zielona Góra
POLAND
WWW.LUMEL.COM.PL

P30H-XX12XXXXX

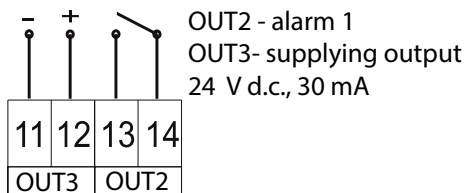

P30H-XX22XXXXX

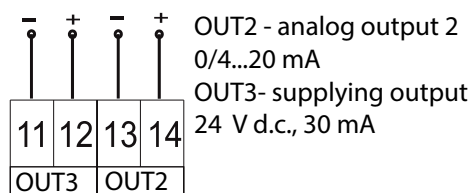

P30H-XX31XXXXX

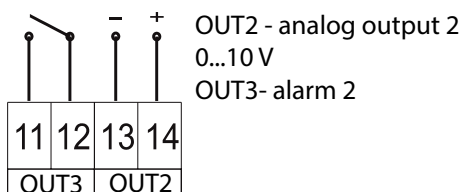

P30H-XX32XXXXX

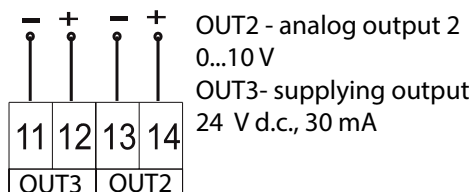

P30H-X001XXXXX

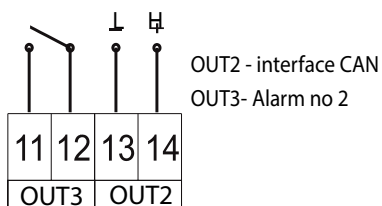

P30H-X002XXXXX

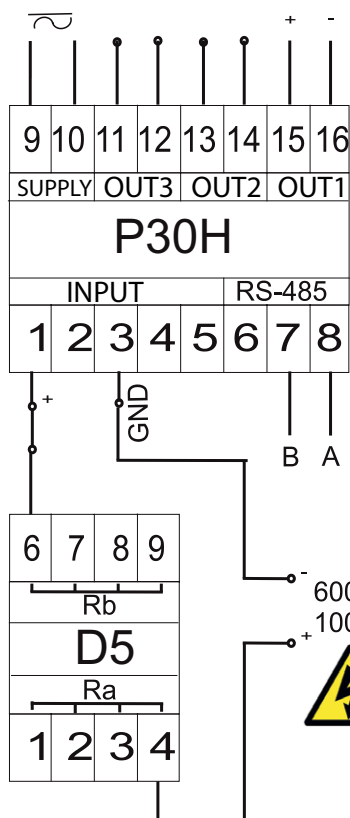
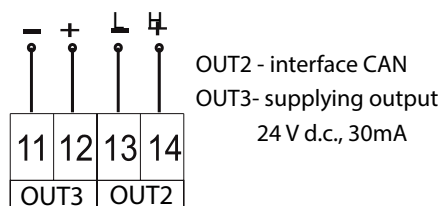

indirect voltage measurement 600 V, 1000 V

ORDERING

Transducer P30H	X	X	X	X	X	XX	X	X
Analog output OUT1:								
current (0/4...20 mA)	1							
voltage (0...10 V)	2							
Additional equipment:								
without	0							
with external SD/SDHC card	1							
with Ethernet interface and archive file system memory	2							
Output OUT2:								
interface CAN with protocol CANopen**	0							
relay A1, 5 A 30 V d.c., 250 V a.c.	1							
analog current output (0/4...20 mA)	2							
analog voltage output (0...10 V)	3							
Output OUT3:								
relay A2, 5 A 30 V d.c., 250 V a.c.	1							
power output 24 V d.c. / 30 mA	2							
Supply:								
85...253 V a.c., 85...300 V d.c.	1							
20...40 V a.c., 20...60 d.c.	2							
Version:								
standard							00	
with CAN interface							03	
custom-made*							XX	
Language:								
Polish								P
English								E
other*								X
Acceptance tests:								
without extra requirements								0
with an extra quality inspection certificate								1
acc. to customer's request*								X

* after agreeing with the manufacturer

** only in version without additional equipment

Order example:

The code **P30H 111210E1** means transducer in standard version with analog current output, with external SD/SDHC card, with relay alarm no.1, with power output 24 V/30mA, with supply 85...235 V a.c./d.c., in English, with an extra quality inspection certificate.

Additional resistance D5	X	X	X
Measuring range in set with P30H:			
600 V	1		
1000 V	2		
Language:			
Polish			P
English			E
other*			X
Acceptance tests:			
without extra requirements			0
with an extra quality inspection certificate			1
acc. to customer's request*			X

* after agreeing with the manufacturer

Order example:

The code **D5 2E1** means additional resistance D5 with measuring range 1000 V, in English, with an extra quality inspection certificate.

SEE ALSO:



Transducer of 1-phase power network parameters - P30P.



3-phase power network meter - ND20.



Current transformers

For more information about LUMEL products please visit our website: www.lumel.com.pl

Export department:
+48 66 45 75 130/ 233/
321/ 366
Fax: +48 66 32 54 091
e-mail: export@lumel.com.pl

LUMEL S.A.
ul. Sulechowska 1
65-022 Zielona Góra
POLAND
WWW.LUMEL.COM.PL