

KD8 SCREEN RECORDER

FEATURES:

IP65



MOD BUS



- Intuitive servicing - LCD TFT 5.7" screen, with touch panel.
- Data archiving on CompactFlash card, capacity up to 4 GB.
- IP65 protection grade on the front panel.
- 3 or 6 analog programmable measuring inputs.
- 6 or 12 alarms outputs.
- 4 or 8 digital inputs.
- Visualization of measurements in digital form, analog indicators, diagrams, bargraphs.
- RS-485 and USB serial interfaces.
- MS Windows® CE operating system.
- PC softwares: KD8 SETUP, KD CHECK, KD CONNECT, KD ARCHIVE.
- Programmable events.
- Menu available in various language versions.

INPUTS:



OUTPUTS:



RS 485

USB

GALVANIC ISOLATION:



Digital interface

EXAMPLE OF APPLICATION

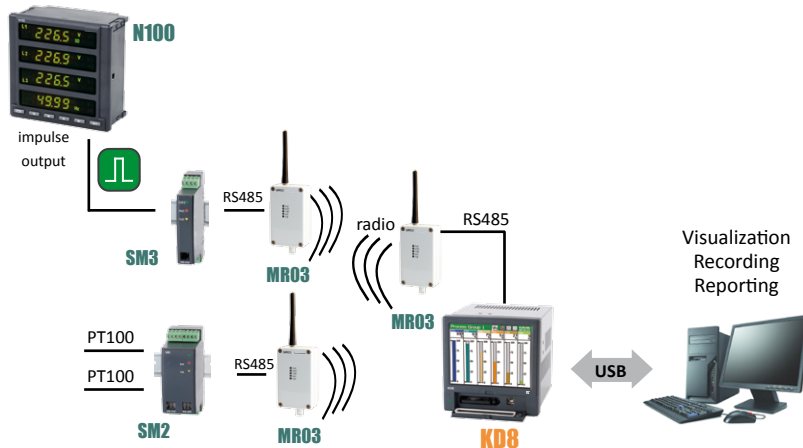

System of measurement, control and recording of temperature and energy with wireless communication.

EXAMPLES OF MEASURING DATA PRESENTATION

Various forms of data display:

- linear diagrams,
- digital indicators,
- analog views,
- bargraphs,
- tables and others. (manual and automatic switching between screens.)

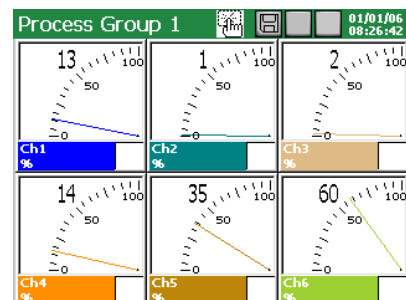
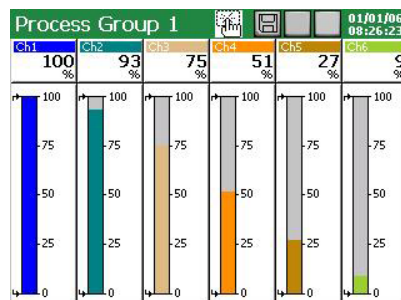
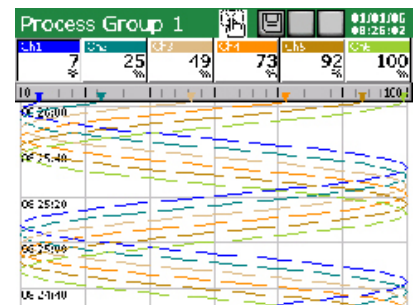
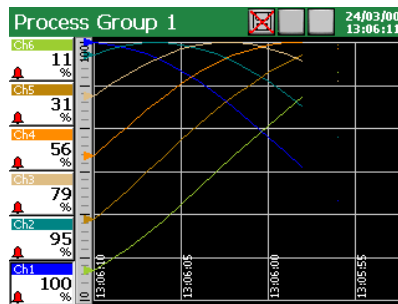

Sifam Tinsley Instrumentation Ltd
Unit 1 Warner Drive,
Springwood Industrial Estate
Braintree, Essex, UK, CM72YW
E-mail: sales@sifamtinsley.com
Web: www.sifamtinsley.com/uk
Contact: +44(0)1803615139



Sifam Tinsley Instrumentation Inc.
3105, Creekside Village Drive,
Suite No. 801, Kennesaw,
Georgia 30144 (USA)
E-mail Id : psk@sifamtinsley.com
Web: www.sifamtinsley.com
Contact No.: +1 404 736 4903



KD8 SCREEN RECORDER

INPUTS					
Input signal	Measuring range/ Accuracy class (%)		Minimal subrange/ Accuracy class (%)		
Voltage	0 .. ±9999 mV	0.15	5 mV	0.25	
Current	0 .. ±20 mA	0.15	1 mA		
Thermocouple (TC): J (Fe-CuNi) K (NiCr-NiAl) N (NiCrSi-NiSi) E (NiCr-CuNi) R (PtRh13-Pt) S (PtRh10-Pt) T (Cu-CuNi) B (PtRh30-PtRh6) L (GOST) K (GOST)	-200 .. 1200°C	0.1	100°C	1	
	-200 .. 1370°C		130°C	0.7	
	-200...1300°C		200°C	0.5	
	-200...1000°C		100°C	1	
	0 .. 1760°C	0.2	540°C	0.3	
	0 .. 1760°C		570°C	0.3	
	-200 .. 400°C	0.1	110°C	0.9	
	400 .. 1820°C	0.2	1000°C	0.2	
	-200 .. 800°C	0.1	90°C	0.2	
	-200 .. 1370°C		130°C	0.7	
Resistance transmitter (RTD): Pt 100 Pt 500 Pt 1000 Ni 100 Cu 100 GR.21 (GOST'78) (GOST'94) 50P (GOST'78) (GOST'94) 100P (GOST'78) 100P (GOST'94) 50M (GOST'78) (GOST'94) 100M (GOST'78) (GOST'94) Potentiometric transmitter Resistance transmitter	-200 .. 850°C	0.15	50°C	0.25	
		0.3		0.5	
		0.3			
	-60 .. 180°C	0.15			0.25
	-50 .. 180°C				
	-260 .. 1100°C				
50 .. 2000 Ω		100 Ω			
0 .. 2000 Ω		100 Ω			
Logic input	control signal 0/5 .. 24 V d.c.		switching frequency up to 50 Hz		

OUTPUTS	
Output type	Properties
Relay	- electromagnetic relays: ≤ 250 V a.c./1 A or ≤ 30 V d.c./1 A

DIGITAL INTERFACE	
Interface type	Properties
RS-485	interface: MODBUS Slave, baud rate 0.3 .. 256 kbit/s, transmission mode: ASCII/ RTU
USB	device V.1.1, socket USB-B

EXTERNAL FEATURES		
Supply voltage	90 .. 230 .. 253 V	input power ≤ 30 VA
Temperature	operating: 0 .. 23 .. 55°C	storage: -20 .. 60°C
Humidity	< 70%	condensation inadmissible

RATED OPERATING CONDITIONS		
Display field	LCD 5.7" TFT type	320 x 240 pixels, with touch screen
Overall dimensions	144 x 144 mm	panel cut-out dimensions: 138+1 x 138+1 mm
Weight	< 2 kg	
Protection grade	from frontal side: IP65	from terminal side: IP20

SAFETY AND COMPATIBILITY REQUIREMENTS		
Electromagnetic compatibility	noise emissions	acc. to EN 61000-6-4
	noise immunity	acc. to EN 61000-6-2
Isolation between circuits	500 V d.c.	acc. to EN 61010-1
Isolation between supply and measuring system	2 kV	
Pollution level	2	
Installation category	II	
Maximal operating voltage in relation to earth	for the measuring system, relays and supply: 500 V	acc. to EN 61010-1
Altitude above sea level	< 2000 m	

SOFTWARES ASSISTING THE KD8 RECORDER WORK:

KD ARCHIVE
Software destined to review and analyse archive data from the recorder on a PC computer, stored in a binary format with digital signature.

KD8 SETUP
Software destined to configure recorder settings by means of a PC computer.

Sifam Tinsley Instrumentation Ltd
Unit 1 Wamer Drive,
Springwood Industrial Estate
Braintree, Essex, UK, CM72YW
E-mail: sales@sifamtinsley.com
Web: www.sifamtinsley.com/uk
Contact: +44(0)1803615139



Sifam Tinsley Instrumentation Inc.
3105, Creekside Village Drive,
Suite No. 801, Kennesaw,
Georgia 30144 (USA)
E-mail Id : psk@sifamtinsley.com
Web: www.sifamtinsley.com
Contact No.: +1 404 736 4903

KD8 SCREEN RECORDER

EXEMPLARY FUNCTIONS OF KD8 ASSISTING SOFTWARES

SOFTWARES ASSISTING THE KD8 RECORDER WORK:

KD CONNECT

Software destined for the communication between the recorder and the PC computer through the USB interface in order to download archive data and record/erase on the CF card.

KD CHECK

Software destined to verify the digital signature in archive data stored in text format.

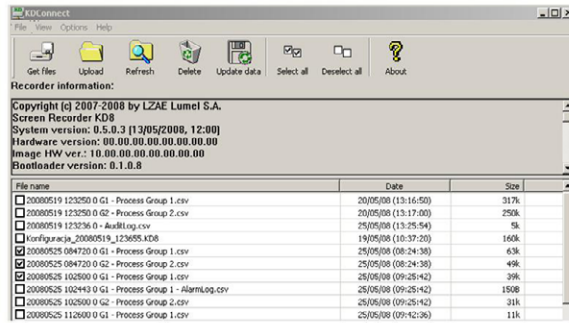

Downloading and erasing of archive data by means of the PC computer - KD CONNECT.

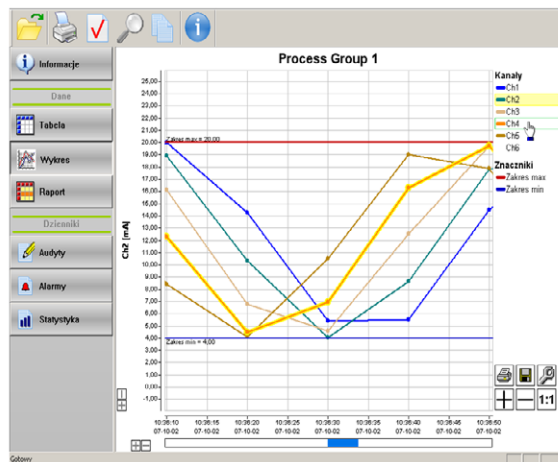

Review of archive data through the PC computer - KD ARCHIVE.

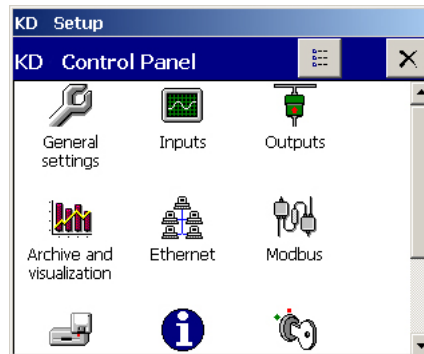

Configuration of the KD8 recorder by means of the PC computer - KD8 SETUP.

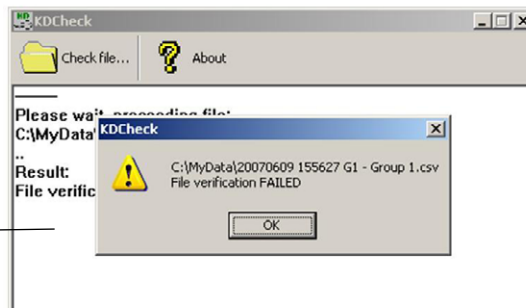

Checking result:
incorrect file verification

Verification of the digital signature of text data - KD CHECK.

Sifam Tinsley Instrumentation Ltd
 Unit 1 Warner Drive,
 Springwood Industrial Estate
 Braintree, Essex, UK, CM72YW
 E-mail: sales@sifamtinsley.com
 Web: www.sifamtinsley.com/uk
 Contact: +44(0)1803615139



Sifam Tinsley Instrumentation Inc.
 3105, Creekside Village Drive,
 Suite No. 801, Kennesaw,
 Georgia 30144 (USA)
 E-mail Id : psk@sifamtinsley.com
 Web: www.sifamtinsley.com
 Contact No.: +1 404 736 4903

OVERALL DIMENSIONS

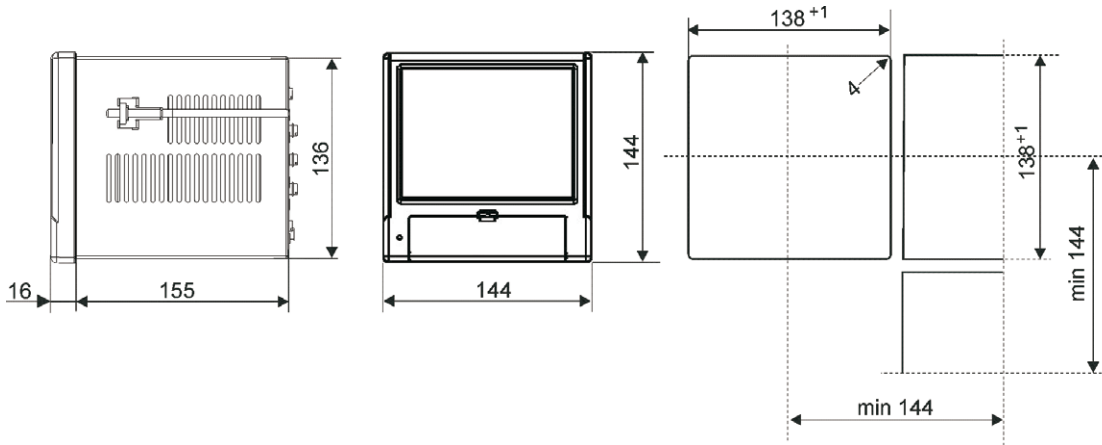

ORDERING

Screen Recorder KD8 -	X	X	X	X	XX	X
Measuring inputs:						
3 programmable measuring inputs	1					
6 programmable measuring inputs	2					
Alarms and binary inputs:						
without alarms and binary inputs	0					
alarms (NO relays) + binary inputs ¹⁾	1					
Supply:						
90..253 V a.c.		1				
Softwares servicing the recorder from PC:						
KD Connect, KD Check				1		
KD Connect, KD Check, KD Archive, KD8 Setup				2		
Version:						
standard					00	
custom-made ²⁾					XX	
Acceptance tests:						
without extra quality inspection requirements						8
with an extra quality inspection certificate						7
with calibration certificate						4
according to customer's request ²⁾						X

¹⁾ for each 3 measuring inputs a package with 6 alarms and 4 binary inputs is installed

²⁾ after agreeing with the manufacturer

Example of order:

the code **KD8-1-0-1-1-00-0** means:

- KD8** - recorder of KD8 type,
- 1** - with 3 programmable measuring inputs,
- 0** - without alarms and binary inputs,
- 1** - supply: 90 .. 253 V a.c.,
- 1** - with KD Connect and KD Check softwares,
- 00** - in standard version,
- 0** - without extra quality inspection requirements.

Sifam Tinsley Instrumentation Ltd
 Unit 1 Warner Drive,
 Springwood Industrial Estate
 Braintree, Essex, UK, CM72YW
 E-mail: sales@sifamtinsley.com
 Web: www.sifamtinsley.com/uk
 Contact: +44(0)1803615139



Sifam Tinsley Instrumentation Inc.
 3105, Creekside Village Drive,
 Suite No. 801, Kennesaw,
 Georgia 30144 (USA)
 E-mail Id : psk@sifamtinsley.com
 Web: www.sifamtinsley.com
 Contact No.: +1 404 736 4903