



DUAL LOOP CONTROLLER RE92 TYPE



USER'S MANUAL



Contents

1. INTRODUCTION	5
1.1. Purpose	5
1.2. Controller properties.....	5
2. CONTROLLER SET	6
3. BASIC REQUIREMENTS, OPERATIONAL SAFETY	7
4. INSTALLATION	7
4.1. Controller installation.....	7
4.2. Electrical connections	9
4.3. Recommendations for installation	14
5. STARTING WORK	15
6. STARTING THE CONTROLLER	15
6.1. Information bar.....	15
6.2. Button markings	16
6.3. Screen with fixed set-point control	16
6.4. Screen with programming control	17
6.5. Screen with the timer function.....	17
6.6. Change of displayed screens	18
6.7. Edit mode	19
6.8. Context menu	21
7. CONTROLLER CONFIGURATION	21
7.1. Menu access password.....	21
7.2. Programming matrix.....	23
7.3. Parameters description.....	24
8. INPUTS AND OUTPUTS OF THE CONTROLLER	40
8.1. Measuring input 1	40
8.2. Measuring input 2.....	41
8.3. Measuring input 3.....	41
8.4. Binary inputs.....	42

9. CONTROLLER OUTPUTS	43
9.1. Controlling outputs	43
9.2. Alarm outputs	45
9.3. Timer function	46
9.4. Retransmission outputs.....	48
9.5. Signal outputs.....	49
10. LOOP CONFIGURATION	50
10.1. Controlled signal.....	50
10.2. Control types	50
10.3. Control range.....	57
10.4. Set value in loop	57
10.5. Control algorithms.....	57
11. PROGRAMMING CONTROL	62
11.1. Description of the programming control parameters.....	62
11.2. Defining the set value programs	65
12. MODBUS	68
12.1. Introduction	68
12.2. Error codes.....	69
12.3. Register map	69
13. SOFTWARE UPGRADE	112
14. TECHNICAL DATA	113
15. CONTROLLER ORDERING CODE	118

This manual is valid for the controller using software v1.07.01.

1. INTRODUCTION

1.1. Purpose

Two-loop RE92 controller used to control temperature and other physical values (e.g. pressure, humidity, flow level). It can control two objects independently or control two physical values in one object (e.g. two-chamber furnaces).

1.2. Controller properties

RE92 controller is characterized by the following features:

- two-loop control and measurement,
- 3,5" TFT full-color screen, resolution: 320 x 240 pixel,
- intuitive handling via six buttons and graphic user interface,
- two universal measuring inputs (for thermoresistors, thermocouples or standard linear signals),
- additional input,
- communication interfaces: RS-485 Modbus Slave, Modbus TCP Slave,
- six binary outputs,
- two voltage and current analog outputs,
- three binary inputs,
- object transducers supply output,
- software upgrade possibility using SD card,
- two-step control, three-step step-by-step control, three-step control of heating-cooling type,
- SMART PID innovative algorithm,
- alarms,
- timers function.

2. CONTROLLER SET

Complete set of the controller includes:

1. controller	1 pc
2. seal.....	1 pc
3. holders to fix the meter in the panel....	4 pcs
4. plug with 16 screw terminals.....	2 pcs
5. plug with 10 screw terminals.....	2 pcs
6. user manual	1 pc
7. guarantee card.....	1 pc

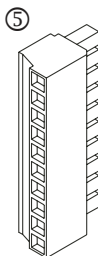
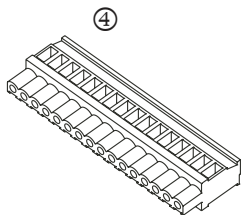
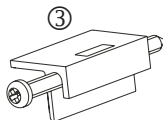

3. BASIC REQUIREMENTS, OPERATIONAL SAFETY

The controller conforms to a safety standard EN 61010-1.



Additional comments concerning safety:

- Assembly and installation of the electrical connections should be conducted only by people authorized to perform assembly of electric devices.
- Always check the state of connections before turning the controller on.
- Prior to taking the controller housing off, always turn the supply off and disconnect measuring circuits.
- Removal of the controller housing during the warranty period voids the warranty.
- The device is designed for installation and usage in the industrial electromagnetic environment.
- A switch or a circuit-breaker should be installed in the building or facility. This switch should be located near the device, easily accessible by the operator, and suitably marked.

4. INSTALLATION

4.1. Controller installation

Fix the controller to the board with three screw brackets as shown in the fig. 1A slot in the panel must have the following dimensions: $92.5^{+0.6} \times 92.5^{+0.6}$ mm. The thickness of the panel material cannot exceed 6 mm.

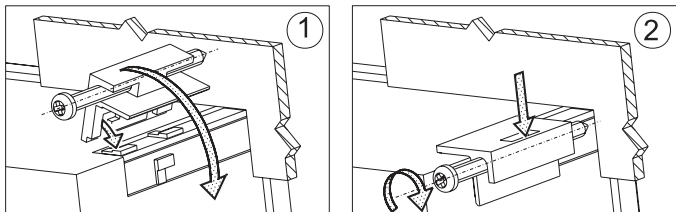

Fig. 1. Controller installation.

Dimensions of the controller are presented on the fig. 2.

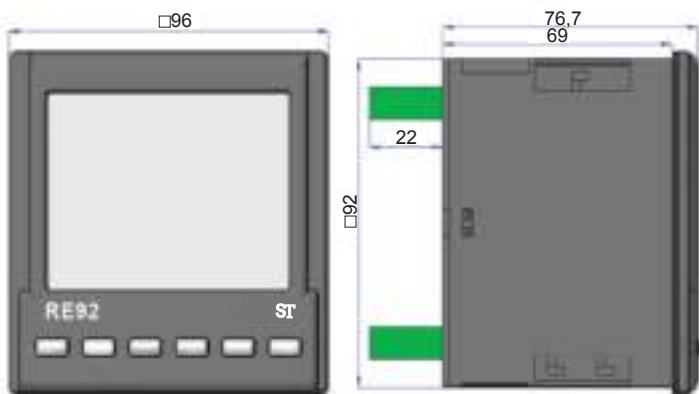

Fig. 2. Controller dimensions.

4.2. Electrical connections

The controller has three separate strips with screw terminals. Two strips with 16 terminals each allow to connect all signal sources by a wire with a 2.5 mm² cross-section, and two strips with 10 terminals each allow for connecting by a wire with 1.5 mm² cross-section.

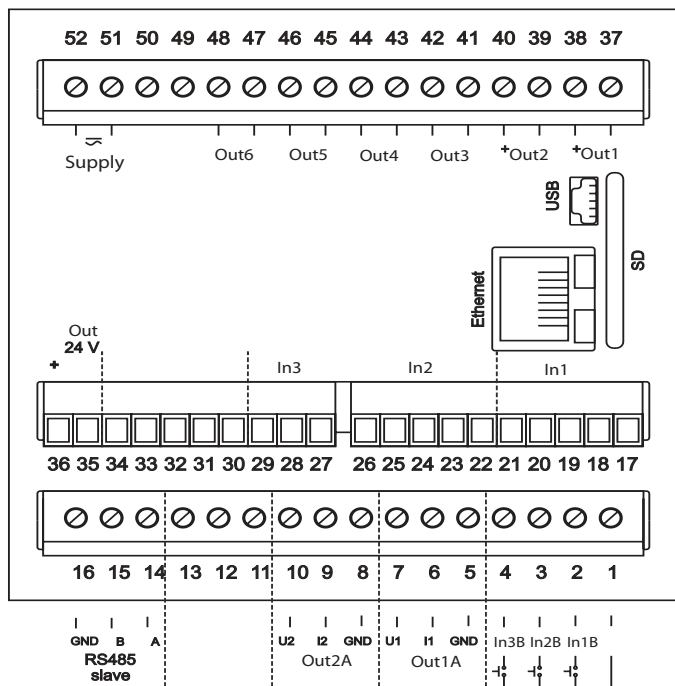

Fig. 3. Connection strips of the controller.

CONNECTING THE SUPPLY



supply should be connected to the terminals 51 and 52, according to technical data

CONNECTION OF 1 AND 2 INPUT

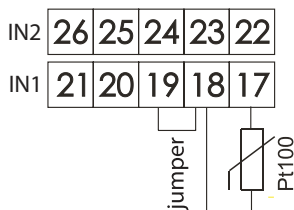

thermoresistor Pt100
in 2-wire system

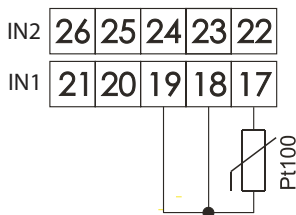

thermoresistor Pt100
in 3-wire system

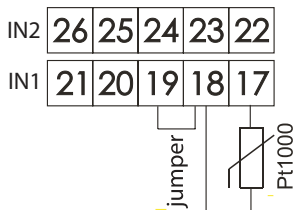

thermoresistor Pt1000

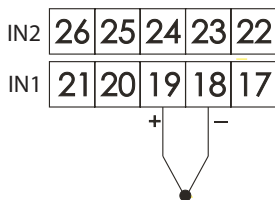

thermocouples

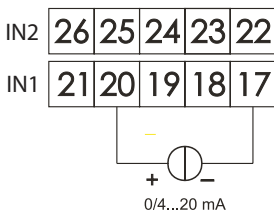

current input
0/4...20 mA

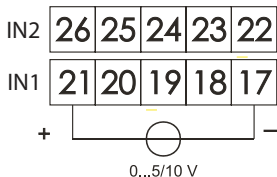

voltage input
0...5/10 V

CONNECTION OF INPUT 3

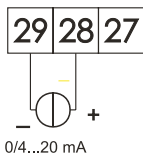

current input
0/4..20 mA

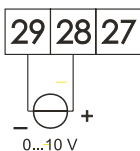

voltage input
0...5/10 V

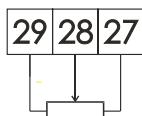

potentiometric
input

CONNECTION OF THE BINARY OUTPUTS

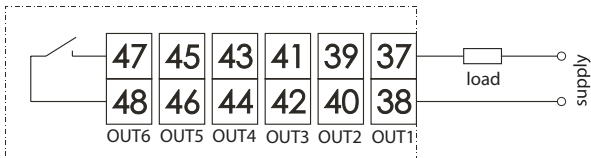

output 1–6 – relay

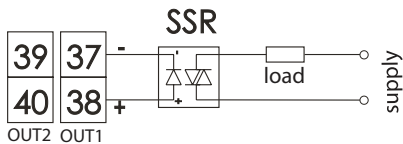

output 1 and 2 – voltage 0/5 V

CONNECTING THE ANALOG OUTPUTS

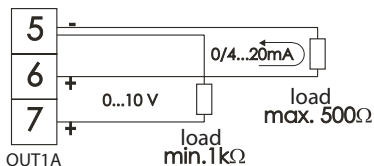

output 1A – current 0/4–20 mA
and voltage 0–10 V

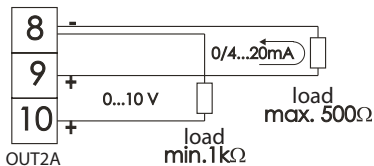

output 2A – current 0/4–20 mA
and voltage 0–10 V

CONNECTING THE BINARY INPUTS



CONNECTING THE RS-485 INTERFACE

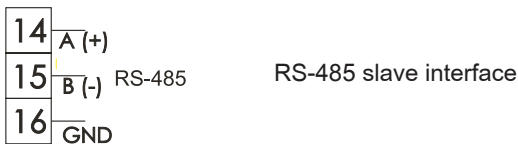

CONNECTING OBJECT TRANSDUCERS SUPPLY

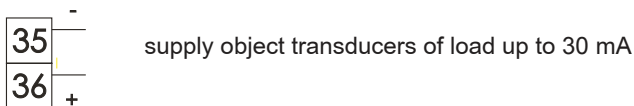

ETHERNET CONNECTION



For Ethernet connection use the category 5 shielded twisted-pair wire with RJ-45 connector, compliant to the following standards:

- EIA/TIA 568A for both connectors in strike-through connection (i.e. between RE92 and hub or switch),
- EIA/TIA 568A for the first connector and EIA/TIA 568B for the second one in the cross-over connection (i.e. when connecting RE92 to the computer).

4.3. Recommendations for installation

To achieve full electromagnetic resistance of the controller, it is necessary to follow the rules described below:

- do not supply the controller from the network in the proximity of devices generating high pulse noises and do not apply common earthing circuits,
- apply network filters,
- wires leading measuring signal should be twisted in pairs and for the resistance sensors in the three-wire connection they should use twisted wires of exactly the same length, cross-section and resistivity protected by shielding,
- all shields should be one-side earthed or connected to the protection wire, the nearest possible to the controller,
- as a rule of thumb, wires transmitting different signals should be spaced as far as it is possible (at least 30 cm) and should be crossed only at the right angle (90 degrees)°.
- to connect RE92 controller to the Ethernet it is recommended to use:
 - U/FTP – twisted pair cable with separate foil shielding for every pair,
 - F/FTP – twisted pair cable with separate foil shielding for every pair and additional foil shielding for the cable,
 - S/FTP (former SFTP) – twisted pair cable with separate foil shielding for every pair and additional mesh cable shielding,
 - SF/FTP (former S-STP) – twisted pair cable with separate foil shielding for every pair and additional mesh and foil cable shielding.

5. STARTING WORK

After turning a supply on, the controller displays logo and then moves to the normal operational mode.

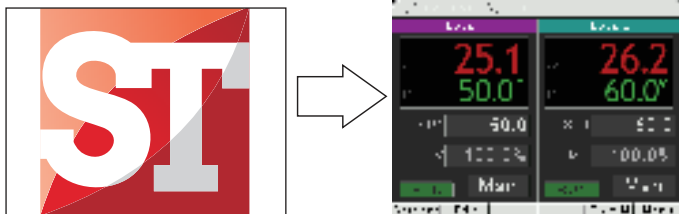

6. STARTING THE CONTROLLER

6.1. Information bar

Information bar displays the state of outputs, binary inputs and real-time clock. When active binary outputs and inputs are displayed in black, inactive ones are displayed in light grey color. State of the outputs, binary inputs and real-time clock can be hidden.

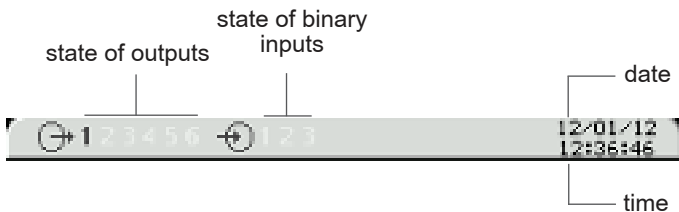

Fig. 4. Information bar

6.2. Button markings

Depending on the service location, controller buttons can perform different functions. Functions are described in the bar on the bottom of the screen. If the button lacks description, it is inactive at the moment. Fig. 5 shows an example of the button marking.

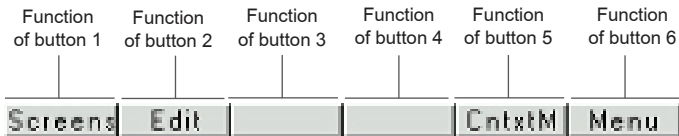

Fig. 5. Buttons marking - example

6.3. Screen with fixed set-point control



Fig. 6. Screen with fixed set-point control

6.4. Screen with programming control



Fig. 7. Screen with programming control

6.5. Screens with the timer function

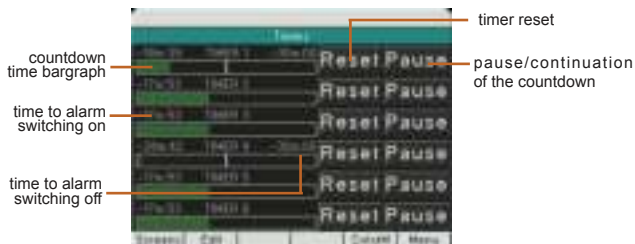

Fig. 8. Alarm Timers screen

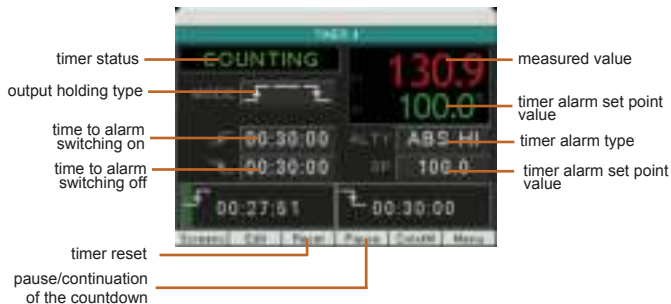

Fig. 9. Single Alarm Timer screen

6.6. Changing the display screens

Pressing the **Screens** button, one can switch between the views of the two channels, the first channel and the second. Figure 6 shows the change in display screens for the regulator with the programming control.



↓ Button **Screens**

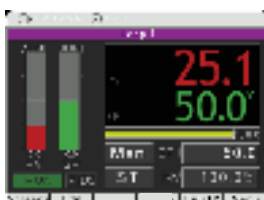

→
via Context
Menu



↓ Button **Screens**

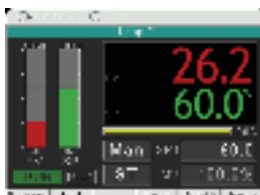

→
via Context
Menu

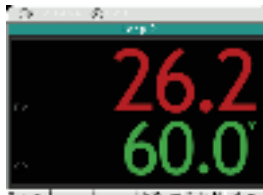

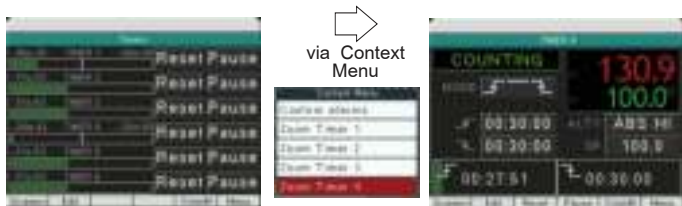

Fig. 10. Change of the displayed screens - example

6.7. Edit mode

Changing the value in the edit field.

To change the value in the edit field (i.e. set value), press the **Edit** button, the first field of the list will be highlighted in yellow. Then use the **◀**, **▼**, **▲**, **▶** buttons to select the edit field for change. After pressing the **Edit** button, use **◀**, **▶** buttons to change the number position; **▼**, **▲** increase or decrease the value of the selected number. The change must be accepted with the **OK** button or cancelled with the **Cancel** button.



Fig. 11. Changing the value in the edit field.

Using the button type field.





To use such field (e.g. start/stop control), press the **Edit** button; the first item in the list will be highlighted in yellow. Then use the , , ,  buttons to select the button type field. Pressing the **Exec** button performs a function appropriate to the given button.



Fig. 12. Using the button type field.

6.8. Context menu

Pressing the **ContxtM** button displays the context menu. This menu allows for quick access to a given feature.

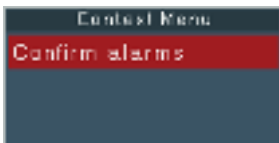
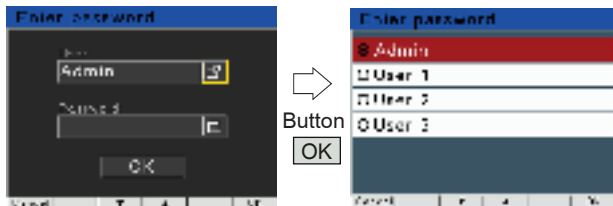

Fig. 13. Context menu

7. CONTROLLER CONFIGURATION

7.1. Menu access password

To switch to the controller configuration from the screen display level, choose the **Menu** button. Use selection and access password window will appear. On the first run, there is only one user *[Admin]* with no set password. It is possible to create four users with different access rights. User *[Admin]* has all the rights, and can set them for the other users. User privileges are selected from the menu: Security → User → Level. *[Level 0]* allows for changing all parameters, including the **[Security]**, *[Level 1]* allows to change all parameters with the exception of the **[Security]** submenu, *[Level 2]* allows for changing the set values, current program, date and time.



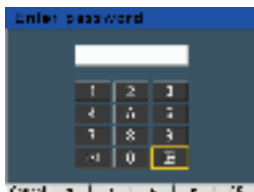
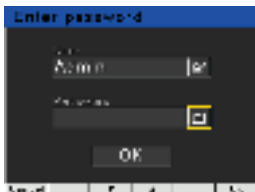

MENU

7.2. Programming matrix

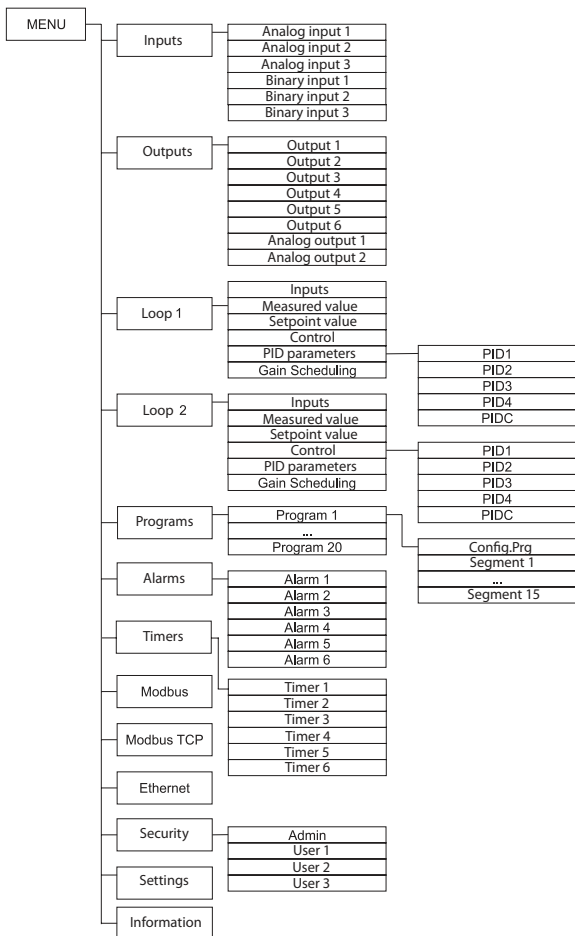

Fig. 14. Programming matrix

7.3. Parameters description

The list of parameters is presented in the table 1.

Lista parametrów konfiguracji

Table 1

Symbol of parameter	Parameter name	Factory setting	Parameter modification range	
			sensors	linear input
Inputs				
Analog input 1				
	Input type	Pt100	Pt100 : thermoresistor Pt100 Pt500 : thermoresistor Pt500 Pt1000: thermoresistor Pt1000 Ni100 : thermoresistor Ni100 Ni1000: thermoresistor Ni1000 Cu100 : thermoresistor Cu100 Tc J : J type thermocouple Tc T : T type thermocouple Tc K : K type thermocouple Tc S : S type thermocouple Tc R : R type thermocouple Tc B : B type thermocouple Tc E : E type thermocouple Tc N : N type thermocouple Tc L : L type thermocouple 0..20mA: linear current 0-20mA 4..20mA: linear current 4-20mA 0..5V : linear voltage 0-5 V 0..10V : linear voltage 0-10 V	

		Unit	°C	°C : degrees Celsius °F : degrees Fahrenheit PU: physical units %: percent %RH: relative humidity	
		Dot.level	DP1	DP0 : without a decimal place DP1 : 1 decimal place	DP0 : without a decimal place DP1 : 1 decimal place DP2 : 2 decimal places
		Compensation	Auto	Auto Manual	
		Comp. temp.	0°C	0...50°C	-
		MinInpAnalog	0	-	-9999...99999
		MaxInpAnalog	100	-	-9999...99999
		Correction	0	-35.00...35.00	
		Filter	0.2	Off: filter off 0.2: time constant 0.2 s 0.5: time constant 0.5 s 1: time constant 1 s 2: time constant 2 s 5: time constant 5 s 10: time constant 10 s 20: time constant 20 s 50: time constant 50 s 100: time constant 100 s	
Analog input 2					
		as per analog input 1			

Analog input 3				
		Input type ¹⁾	4..20mA 0..10V R100	0..20mA: linear current 0-20mA 4..20mA: linear current 4-20mA 0..5V: linear voltage 0-5 V 0..10V: linear voltage 0-10 V R100: potentiometric input 100 Ohm R1000: potentiometric input 1000 Ohm
		Unit	°C	°C : degrees Celsius °F : degrees Farenheit PU: physical units %: percent %RH: relative humidity
		Dot.level	DP1	DP0 : without a decimal place DP1 : 1 decimal place DP2 : 2 decimal places
		MinWeAnalog	0	-9999...99999
		MaxWeAnalog	100	-9999...99999
		Korekta	0	-35.00...35.00
		Filter	0.2	Off: filter off 0.2: time constant 0.2 s 0.5: time constant 0.5 s 1: time constant 1 s 2: time constant 2 s 5: time constant 5 s 10: time constant 10 s 20: time constant 20 s 50: time constant 50 s 100: time constant 100 s
Binary input 1				
		Function	none	none: none Stop: stop automatic control (response to a level) ManualOp: switching to manual operation (response to a level) SP+1: switching to subse quent SP(response to a level)

				<p>StartPrg: program start (response to the rising edge)</p> <p>NextSegment: jump to the next segment (response to the rising edge)</p> <p>PrgBlock: stop the incrementing of the set point in the program (response to a level)</p> <p>PrgEnd: end of the program (response to the rising edge)</p> <p>PrgStop: stop of the program with possible continuation (response to the rising edge)</p> <p>PrgStopBeg: stop the program and jump to the beginning (response to the rising edge)</p> <p>SP-IN3: switching to subsequent SP from the additional input (response to the rising edge)</p> <p>Reset timer1: alarm reset of timer 1</p> <p>Reset timer2: alarm reset of timer 2</p> <p>Reset timer3: alarm reset of timer 3</p> <p>Reset timer4: alarm reset of timer 4</p> <p>Reset timer5: alarm reset of timer 5</p> <p>Reset timer6: alarm reset of timer 6 (response to a level)</p> <p>SP-IN1: switching to SP from the first input (response to the rising edge)</p> <p>SP-IN2: switching to SP from the second input (response to the rising edge)</p>
Binary input 2				
		as per binary input 1		

Binary input 3			
		as per binary input 1	
Outputs			
Output 1			
		Connections	<p>None</p> <p>None: none Loop 1: loop 1 Loop 2: loop 2 Input 1: input 1 Input 2: input 2 Input 3: input 3 INP1+2+3: input 1 + input 2 + input 3 BinInp1: binary input 1 BinInp2: binary input 2 BinInp3: binary input 3 InvBinInp1: inverted binary input 1 InvBinInp2: inverted binary input 2 InvBinInp3: inverted binary input 3</p>
		Function	<p>None: none Heating: heating Cooling: cooling Opening: valve opening Closing: valve closing Alarm: alarm Event Prg: progr. control event CascadeSlv: signal of the slave loop with cascade control Timer: alarm timera</p> <p>Caution! When the heating-cooling function is selected, please keep in mind that it should be consistent with the type of control selected in the channel, which the output is assigned to.</p>

		Prg.Occ	None	None: none Occ.1.Sec: event 1 from a section Occ.2.Seg: event 2 from a section Occ.3.Sec: event 3 from a section Occ.4.Sec: event 4 from a section Occ.5.Sec: event 5 from a section Occ.6.Sec: event 6 from a section Prg.Block.: deviation block
		Output type	-	None: none Transmitter: relay putput SSR: SSR output
		Imp. period	20.0	0.5...99.0
Output 2				
...				
Output 6				
		as per output 1		
Analog output 1				
		Connections	None	None: none Loop 1: loop 1 Loop 2: loop 2 Input 1: input 1 Input 2: input 2 Input 3: input 3 INP1+2+3: input 1 + input 2 + input 3
		Function	None	None: none Heating: heating Cooling: cooling Retransmission: retransmission Caution! When the heating-cooling function is selected, please keep in mind that it should be consistent with the type of control selected in the channel, which the output is assigned to.

		Retr. source	PV	PV: measuring value SP: set value Deviation: set value - measuring value
		Min for retri.	0	-9999...99999
		Max for retri.	100	-9999...99999
		I-type output	4-20 mA	4-20mA: current 4...20 mA 0-20mA: current 0...20 mA
		U-type output	0-10V	0-10V: voltage 0...10 V
Analog output 2				
		as per analog output 1		
Loop 1				
Inputs				
		Measuring value		Inp1: input 1 Inp2: input 2 Inp3: input 3 Inp1+Inp2: input 1 + input 2 Inp1+Inp3: input 1 + input 3 Inp2+Inp3: input 2 + input 3
		Val for Inp1	1	-10.00...10.00
		Val for Inp2	1	-10.00...10.00
		Val for Inp3	1	-10.00...10.00
		Binary inp.		None: none BinInp1: binary input 1 BinInp2: binary input 2 BinInp3: binary input 3 BinInp1,2: binary input 1 and 2 BinInp1,3: binary input 1 and 3 BinInp2,3: binary input 2 and 3 BinInp1,2,3: binary input 1, 2 and 3

Set point value				
		SP type	SP1	SP1: SP1 set point value SP2: SP2 set point value SP3: SP3 set point value SP4: SP4 set point value IN3: set point value from input 3 PRG: set point value from program IN1: set point value from input 1 IN2: set point value from input 2
		Program no.	Prg01	Prg01: program no 1 Prg02: program no 2 Prg03: program no 3 Prg04: program no 4 Prg05: program no 5 Prg06: program no 6 Prg07: program no 7 Prg08: program no 8 Prg09: program no 9 Prg10: program no 10 (for loop 2: Prg11–Prg20)
		SP1	0	-9999...99999
		SP2	0	-9999...99999
		SP3	0	-9999...99999
		SP4	0	-9999...99999
		SPL	-199	-9999...99999
		SPH	999	-9999...99999
		SP accrual	Off	Off: off accrual/min: accrual in units / minute accrual/h: accrual in units / hour
		Ramp rate	0	-9999...99999

Control				
		Control type	Heating	<p>Off: control off</p> <p>Heating: heating-type control</p> <p>Cooling: cooling-type control</p> <p>Heat-Cool: heating-cooling control</p> <p>Valve: step-by-step valve control</p> <p>Feedback valve.: step-by-step feedback valve control</p> <p>Caution!</p> <p>When the heating-cooling function is selected, please keep in mind that it should be consistent with the type of control selected in the channel, which the output is assigned to.</p>
		Algorithm	PID	<p>On-Off: on-off algorithm</p> <p>PID: PID algorithm</p>
		Hysteresis	2	0.1...100.0
		Distance	0.0	-99.9...99.9
		Valve Open Time	30 s	3...600 s
		Valve Close Time	30 s	3...600 s
		Min Work Time	0.1 s	0.1...99.0 s
		Out Min	0,00%	0.0...100.0 %
		Out max	100.00%	0.0...100.0 %
		Signal damage	0	-100.0...100.0
		Lower reg. threshold	0	-9999...99999

		Upper reg. threshold	800	-9999...99999
PID Parameters				
PID 1				
		Pb	30.0 °C	0.1...550.0 °C (0.1...990.0 °F)
		Ti	300 s	0...9999 s
		Td	60.0 s	0.0...2500.0 s
		Y0	0.00%	0...100.0 %
PID 2				
PID 3				
PID 4				
		as per PID1		
PID C				
		Pb	100.00%	0.1...200.0 %
		Ti	300 s	0...9999 s
		Td	60.0 s	0.0...2500.0 s
Gain Scheduling				
		GS Type	Off	Off: off SP: switched according to set value Set: fixed set
		GS level no.	2	2: 2 PID sets used 3: 3 PID sets used 4: 4 PID sets used
		GS Level 1-2	0	-9999...99999
		GS Level 2-3	0	-9999...99999
		GS Level 3-4	0	-9999...99999

		GS Set	PID1	PID1: PID1 set PID2: PID2 set PID3: PID3 set PID4: PID4 set
Loop 2				
		as per loop 1 and additional:		
Programs				
Program 1				
		Config. Prg		
		PrgStart	Start PV	Start SP Start PV
		Start SP	0	-9999...99999
		Time Unit	mm:ss	mm:ss hh:mm
		Ramp Unit	Min	Min Hour
		Block	Off	Off Lower Upper Intern.
		Cycles Number	1	1...9999
		Supply decay	Continuation	Continuation Stop
		End prg.	Stop	Stop Last SP
		Gain scheduling	Off	Off On

Segment 1			
	Section type	Time	Time Accrual Hold End
	Target SP	0	-9999...99999
	Segment time	00:00	00:00... 99:59
	Ramp rate	0.1	0.1...999.9
	Deviation	0	-9999...99999
	Event 1	Off	Off On
	Event 2	Off	Off On
	Event 3	Off	Off On
	Event 4	Off	Off On
	Event 5	Off	Off On
	Event 6	Off	Off On
	PID set	PID1	PID1 PID2 PID3 PID4
Segment 2			
	...		
Segment 10			

		as Segment 1			
Program 2					
...					
Program 20					
		as Program 1			
Alarms					
Alarm 1					
		Type	Abs. upper	Abs. upper.: absolute upper Abs. lower.: absolute lower Rel. upper.: relative upper Rel. lower.: relative lower Rel. intern.: relative internal Rel. extern.: relative external	
		SP	100	-9999...99999	
		Deviation	0	-9999...99999	
		Hysteresis	2	0.1...99.9	
		Memory	Off	Off: off On: on	
Alarm 2					
...					
Alarm 6					
		as Alarm 1			
Timers					
Timer 1					
		Function	Off	Off: alarm timer disabled On: alarm timer enabled	
		Time	00:30:00	00:00:01...23:59:59	

		Output latch	Continuous	Continuous: continuous output latch Timer: to latch the output for a certain time
		Latch time	00:30:00	00:00:01...23:59:59 (active if Output latch: Timer)
		Type	AbsHigh	AbsHigh: absolute upper AbsLo: absolute lower (active if Output → Assignment: Input 1 or Input 2 or Input 3 or INP1+2+3)
		SP	100,0	-9999...99999 (active if Output → Assignment: Input 1 or Input 2 or Input 3 or INP1+2+3)
Timer 2				
...				
Timer 6				
		as Timer 1		
Modbus				
		Address	1	1...247
		Speed	9600 bps	4800 bps 9600 bps 19.2k bps 38.4k bps 57.6k bps 115.2k bps
		Mode	RTU 8N2	Off RTU 8N2 RTU 8E1 RTU 8O1 RTU 8N1

Modbus TCP ²⁾				
		On	No	No Yes
		Port number	502	0...65535
Ethernet ²⁾				
		DHCP	On	Off: off On: on
		IP Address	127.0.0.1	0.0.0.0...255.255.255.255
		Subnet mask	255.0.0.1	0.0.0.0...255.255.255.255
		Default gateway	0.0.0.0	0.0.0.0...255.255.255.255
Safety				
Admin				
		On	Yes	No Yes
		Password		0...99999999
User 1				
		On	Yes	No Yes
		Level	Level 2	Level 0: all parameters change Level 1: change of all parameters other than the Security submenu Level 2: change of SP, program number, clock settings
		Password		0...99999999
User 2				
		same as User 1		
User 3				

		same as User 1		
Settings				
		LCD illumination	100%	0...100 %
		Language	Polish	English Polish Deutsch
		Show out state	No	No Yes
		Show b.inp state	No	No Yes
		Show clock	No	No Yes
		Hours		
		Date		
		Manufacturer's settings		Revert to manufacturer's settings (other than Ethernet group settings)
Information				
		Type	RE92	
		Loader version	eg. 1.00	
		Program version	eg. 1.00.00	
		Serial number	eg. 12010001	
		MACAddress ²⁾		

- 1) – default setting and extent of the changes depends on input 3 field in the ordering code
2) – shown for Ethernet version

8. INPUTS AND OUTPUTS OF THE CONTROLLER

RE92 controller is fitted with two measuring inputs, one additional input (optional) and three binary inputs.

8.1. Measuring inputs 1

Input 1 is the source of the measured value used for control and alarms.

Input 1 is an universal input capable of accommodating various sensors or standard signals. Input signal is selected with a **[Input type]** parameter. Displayed unit is set through the **[Unit]** parameter. Position of the decimal point that determines measured and set values is set through the **[Digit Point]** parameter.

For thermocouple, a cold terminal compensation must be set through a **[CJC Type]** parameter. When the **[CJC Type]** parameter is set to *[Auto]*, compensation is automatic; when it is set to *[External]*, the compensation temperature is set by the **[CJC Temp]** parameter.

For the linear inputs, set the indication for the lower and upper analog input threshold through the **[LowScale]** and **[HighScale]** parameter.

Correction of the indicated measuring value is done through the **[Shift]** parameter.

When the measuring value is unstable, a digital filter with a programmable time constant value may be used. When using this feature, use the lowest filter time constant value that allows for the stable measuring value. When the time constant is too high, it may cause the control to become unstable. The range of a filter time constant – a **[Filter]** parameter – may be set to 0.2 to 100 seconds.

Measuring input 1 parameters can be found in menu: Inputs → Analog input 1.

8.2. Measuring input 2

Input 1 is the source of the measured value used for control and alarms.

Measuring input 2 parameters are the same as the ones for input 1 can be found in menu: Inputs → Analog input 2.

8.3. Measuring input 3

Input 3 may be used as:

- signal controlled for any loop (as the independent input or component for compound signal on different input),
- set value for any loop,
- additional measurement point – displayed on a measurement screen.

Input 3 is an input that can accommodate the standard signals. Input signal is selected with a [**Input type**] parameter. Displayed unit is set through the [**Unit**] parameter. Position of the decimal point that determines measured and set values is set through the [**Digit Point**] parameter.

Set the indication for a lower and upper analog input threshold through the [**LowScale**] and [**HighScale**] parameter.

Correction of the indicated measuring value is done through the [**Shift**] parameter.

When the measuring value is unstable, a digital filter with a programmable time constant value may be used. The range of a filter time constant – a [**Filter**] parameter – may be set to 0.2 to 100 seconds.

Measuring input 3 parameters can be found in menu: Inputs → Analog input 3.

8.4. Binary inputs

The function of the binary inputs are set through the [**Function**] parameter that can be found in: menu: Inputs → Binary input 1, Inputs → Binary input 2 and Inputs → Binary input 3. Then you need to allocate binary inputs to the appropriate loop.

The following functions of the binary input are available:

- **no function** – state of binary input does not influence the controller operation,
- **stop** – during active binary input the control is interrupted and control outputs start to function as after sensor failure; alarm and retransmission operate normally,
- **switch to manual** – during active binary input, the controller is in the manual operation mode,
- **switch to the next SP** – during active binary input the set point value is switched to another (eg. from SP1 to SP2)
- **program start** – after activation of binary input, the process of programming control starts,
- **jump to next segment** – after activation of binary input, follows the jump to the next segment of programming control,
- **stop counting program set value** – during active binary input, follows the stop of set value counting for programming control
- **end of the program** – jump to the end of the program after activation of the binary input,
- **stop of the program with possible continuation** – control stop and the program stop at the current position after activation of the binary input,
- **stop the program and jump to the beginning** – control stop and the program jump to start after activating the binary input,

- **switching to SP from the additional input** – set point is switched to the value of the additional input during active binary input.
- **Alarm timer reset** – enabling the binary input turns off the alarm relay responsible for the alarm timer and reset of the timer.

Note!

If one channel is assigned to more than one binary input, than for each of them must be set a different function.

9. CONTROLLER OUTPUTS

RE92 controller has six binary outputs and two analog outputs: current and voltage (optional).

9.1. Controlling outputs

[*Heat*] function output is a reverse output. It is used during control, when the increase of the controlled signal causes the value of output signal to drop. Such output is allocated during the loop configuration to the heating control, heating loop in the heating cooling control or valve opening in the step-by-step control.

[*Cool*] function output is a non-reverse output (direct). It is used during control, when the increase of the controlled signal causes the value of output signal to increase. Such output is allocated during the loop configuration to the cooling control, cooling loop in the heating-cooling control or valve closing in the step-by-step control.

For the proportional control (with the exception of the analog outputs) an impulse period is also set. Impulse period is a time between two subsequent input engagements during proportional control. Impulse period length should be adjusted for the dy-

dynamic properties of the object and characteristics of the output device. It is recommended to use SSR transmitter for quick processes. Relay output is used for a contactor control in the slow-changing processes. Long impulse periods for quick-change processes may cause unnecessary oscillation. In theory, the shorter impulse period is, the better the control, however for the relay output a period should be as large, as possible to optimize lifespan of the relay.

Impulse period setting recommendations

Table 2

Output	Impulse period is	Load
electromagnetic transmitter	recommended >20 s, min. 10 s	2 A/230 V a.c.
	min. 5 s	1 A/230 V a.c.
transistor output	1...3 s	semiconductor transmitter (SSR)

9.2. Alarm outputs

Alarm configuration is done in two steps:

1. In **[Output k]** submenu - where $k=1\dots6$ (menu: Outputs):
 - select the number of loop or input allocated to the output being configured – **[Assignment]** parameter,
 - set **[Function]** parameter to *[Alarm]*.
2. In **[Alarms]** submenu, for every output defined as alarm output, please set:
 - alarm type – **[Type]** parameter,
 - set value – **[SP]** parameter - it is the controlled or measuring signal value that engages the input,
 - deviation from the value set in the loop **[Deviation]** parameter - it is the control deviation that engages the input,
 - input engagement hysteresis – **[Hysteresis]** parameter - a zone around the set value in which output state does not change,
 - alarm memory - **[Latch]** parameter, **[Yes]** - means that the alarm will be locked until confirmed by operator.

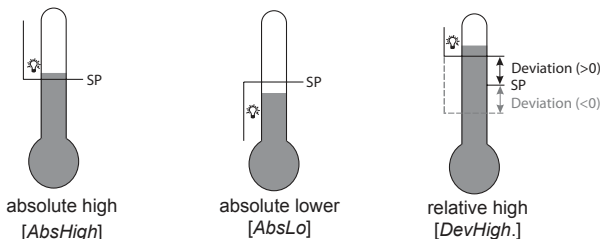

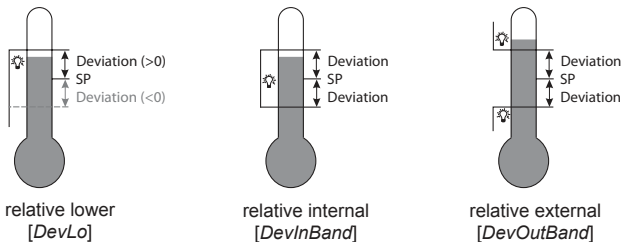

Fig. 15. Alarm types

9.3. Timer function

Timers configuration is done in two steps:

1. In **[Output k]** submenu - where $k=1\dots6$ (menu: Outputs):
 - select the number of loop or input allocated to the output being configured – parameter **[Assignment]**,
 - the parameter **[Function]** set to **[Timer]**.

2. In **[Timer k]** submenu - where $k=1\dots6$ (menu: Timers) for each timer:
 - enable timer function – parametr **[Function]**,
 - set time – parametr **[Time]** – it is time from which, upon the controller reaches the set point temperature (SP), the timer starts counting down. Alarm timer is set and a relay responsible for the alarm timer is actuated after deduction to zero,
 - select the type of output latch – parameter **[Uphold output]**
 - select time of output latch – parameter **[Uphold time]** – it is time which starts to be counted down when the alarm timer is set and the relay responsible for the alarm timer function is actuated. Alarm timer is reset and a relay is switched off after deduction to zero,

- select the alarm type – parameter [Type] – set this parameter if in the [Output -> Assignment] submenu is selected: **Input 1, Input 2, Input 3, INP1+2+3,**
- set a set point – parameter [SP] - set this parameter if in the [Output -> Assignment] submenu is selected: **Input 1, Input 2, Input 3, INP1+2+3.**

If in the [Output -> Assignment] submenu is selected: **loop 1** or **loop 2** a timer function works for a control only: **heating, cooling.**

Reset the timer to update the parameters in case of any settings were changed on the enlarged timer screen.

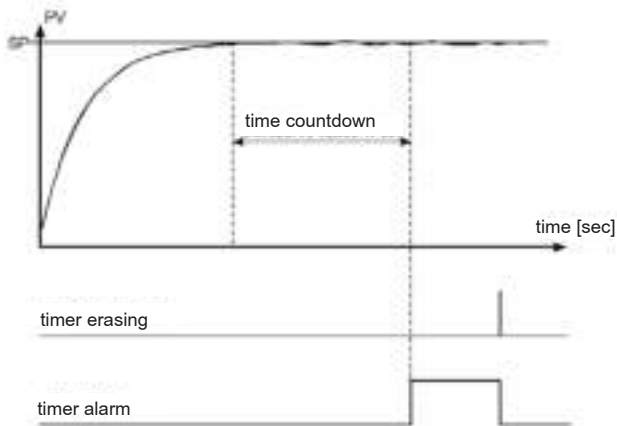

Fig. 16. The principle of operation of the timer during a continuous latch.

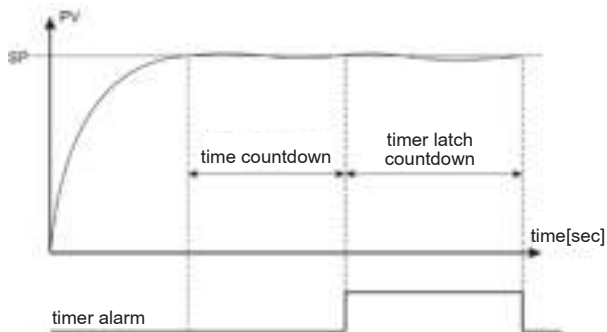

Fig. 17. The principle of operation of the timer during a timer latch.

9.4. Retransmission outputs

Analog output may be used for retransmission of the selected value, e.g. for registering object temperature or copying set values in multi-zone furnaces.

Signal retransmission is possible if the controller is fitted with analog output 1 or 2.

Set **[Function]** parameter to *[Retransmiss]*. Type of a signal to be retransmitted is set through the **[Retr Source]** parameter. Signal can be chosen from: *[PV]* – controlled signal, *[Deviation]* – control deviation a *[SP]* – set point value. The next parameter, **[Output Type]**, sets the analog output range. Additionally, it is necessary to set upper and lower limit of the signal to be retransmitted **[Retr Min]** and **[Retr Max]**.

Retransmission output parameters can be found in menu: Outputs → Analog output 1 and Outputs → Analog output 2.

Picture 18 shows method of transforming the retransmitted signal into proper analog output signal.

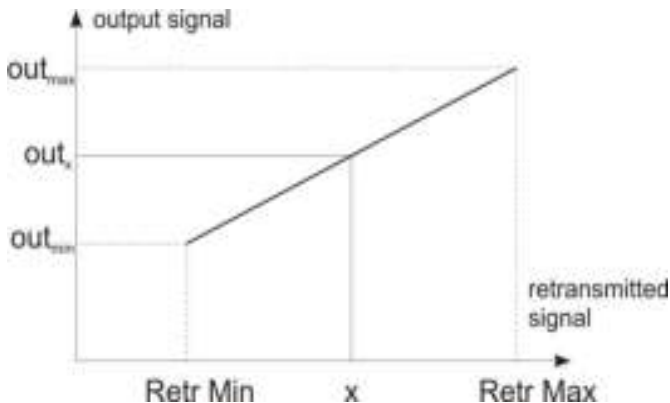

Fig. 18. Transformation of the signal to be retransmitted

The **[Retr Min]** parameter may be higher than **[Retr Max]**, but this will cause the output signal to be inverted.

9.5. Signal outputs

Any binary output can be used for „retransmission” of the state of given binary input. To do this, while configuring the **[Assignment]** parameter choose the:

- **[EvIn1]** – binary input 1 short-cut will activate the output,
- **[EvIn2]** – binary input 2 short-cut will activate the output,
- **[EvIn 3]** – binary input 3 short-cut will activate the output,
- **[EvIn1Neg]** – binary input 1 release will activate the output,
- **[EvIn2Neg]** – binary input 2 release will activate the output,
- **[EvIn3Neg]** – binary input 3 release will activate the output.

10. LOOP CONFIGURATION

10.1. Controlled signal

The signal controlled in a loop might be a measurement from the selected source (Inp1, Inp2, Inp3) or combination of the measured values from two inputs.

Combined control signal is calculated by the controller, using the following formula:

$$\text{Controlled signal} = [\text{Coeff. for Inp } k] * \text{Inp } k + [\text{Coeff. for Inp } k] * \text{Inp } k$$

Where k is a input number (1...3).

Example 1:

To control the difference between input 2 and input 3 signals, enter:

$$[\mathbf{PV}] = [\text{Inp2} + \text{Inp3}]; \quad [\text{Coeff for Inp 2}] = 1,0 \quad [\text{Coeff. for Inp 3}] = -1,0.$$

Example 2:

To control the mean of input 1 and input 2 signals, enter:

$$[\mathbf{PV}] = [\text{Inp1} + \text{Inp2}]; \quad [\text{Coeff. for Inp 1}] = 0.5 \quad [\text{Coeff. for Inp 2}] = 0.5.$$

10.2. Control types

Heating-type control

Controller uses this type of control when the parameter [**Control Type**] in menu: Loop 1 → Control or Loop 2 → Control is set to [*Heat*]. It is a reverse control, when the increase of the controlled signal causes the value of output signal to drop. Output allocated to the loop must have the [*Heat*] function set.

Cooling-type control

Controller uses this type of control when the parameter [Control Type] in menu: Loop 1 → Control or Loop 2 → Control is set to [Cool]. It is a non-reverse (direct) control, when the increase of the controlled signal causes the value of output signal to increase. Output allocated to the loop must have the [Cool] function set.

Control with two heating-cooling loops

Controller uses this type of control when the parameter [Control Type] in menu: Loop 1 → Control or Loop 2 → Control is set to [Heat-Cool]. For every control loop, set the distance range – [Dead Band] parameter and select the parameter set for PID and PIDC cooling.

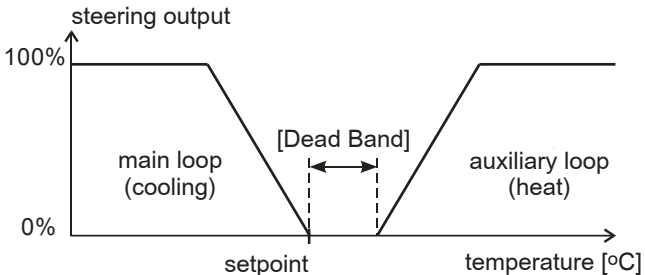

Fig. 19. Control with two heating-cooling loops

Three-step, step-by-step control

The controller offers two algorithms of the step-by-step control for cylinder control:

- with no feedback signal from the valve – opening and closing of the valve is based on PID parameters and control deviation,
- with the feedback signal from the valve positioning device – opening and closing of the valve is based on PID, control deviation and valve position read from the input 3.

To select the three-step step-by-step control, the **[Control Type]** parameter in menu: Loop 1 → Control or Loop 2 → Control should be set to *[Valve]* or to *[Valve Fdb]*. For every control loop, set the insensitivity range for the set point, in which the valve does not change its position - the parameter **[Dead Band]** and select the set of PID parameters. Auto-tuning algorithm is not available for the step-by-step control.

Step-by-step control with no feedback additionally requires the parameters settings: valve open time **[Valve Open Time]**, valve close time **[Valve Close Time]**, minimum valve work time **[Min Work Time]**.

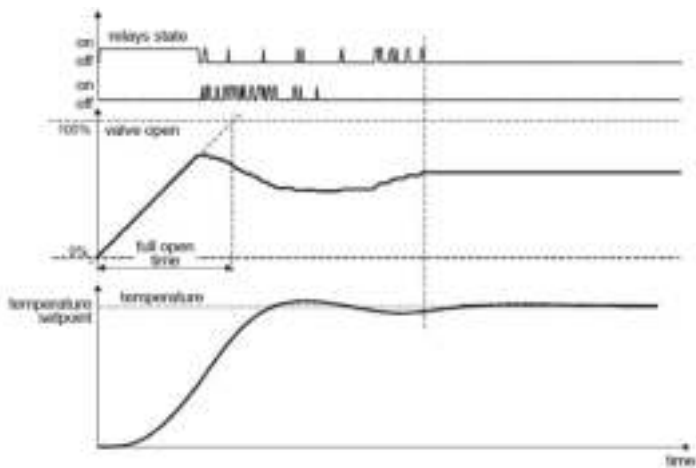

Fig.20. Three-step step-by-step control with no feedback

The principle of the algorithm shown in Fig. 16 is based on conversion of changing the control signal to the relay opening / closing time referred to the full opening / closing time.

The differences between the calculated and the actual valve position are unavoidable because of multiple changes in the direction of valve movement due to the inertia of a drive or its wear in the absence of a feedback. The controller uses the function of automatic positioning of a drive during operation to eliminate these differences. This function does not require user intervention and its function is to extend switching on time of the relay when the control signal reaches 0% or 100%.

The relay for opening / closing will remain on for a time equal to the time of a valve full open / close from a moment of a signal reaching 100% / 0%.

The positioning of the valve will be stopped once the signal is equal to the maximum value.

In the specific case, the positioning is performed by completely closing the valve, it is carried out each time after:

- turning the controller supply on
- changing full open / close time.

The time of full opening of the valve can have a different value than the time of closing.

Both parameters should be set to the same value when using a drive with identical times.

Cascade control

Cascade control is used in the processes with a high latency to obtain the best quality of control.

Second loop works as a slave controller which controls the output. First loop works as the master controller and sets the set point for the slave controller.

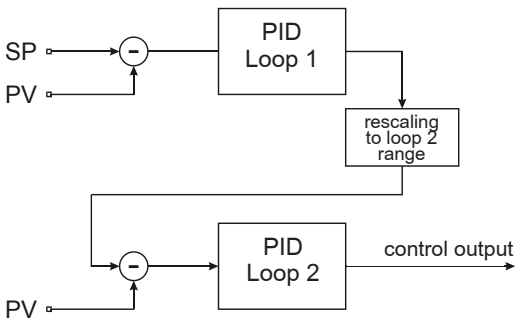

Fig. 21. Cascade control

First loop should be set to PID control to select the cascade control. In the second loop the parameter [**Control type**] in menu: Loop 2 → Control should be set to [*Cascade*]. For rescaling the master loop output set the parameters [**Casc.SO Lo**] and [**Casc.SO Hi**] in menu: Loop 2 → Set value.

„Gain Scheduling” Function

For control systems, where the object behaves decidedly differently in various temperatures, it is recommended to use the „Gain Scheduling” function. The controller allows to remember up to four sets of PID parameters and switch them over automatically. Switching between PID sets runs percussiveless and with a hysteresis to eliminate the oscillations on switching limits.

The parameter [**Typ GS**] settles the way of the function operation.

[Off]	The function is disabled
[SP]	<p>a) Switching depending on the set point value. Additionally, one must also choose the number of PID sets – parameter [GS Level Nb], and set their switching levels in dependence from the number of PID sets [GS Level 1-2], [GS Level 2-3], [GS Level 3-4].</p> <p>b) For the programmed control, one can set the PID set individually for each segment. First, for the given program, one must set the parameter [Gain Scheduling] in the menu: Programs → Program x → Config Prg to [<i>On</i>].</p>
[Set]	Permanently setting of one PID set. The PID set is set through the [GS Set] parameter.

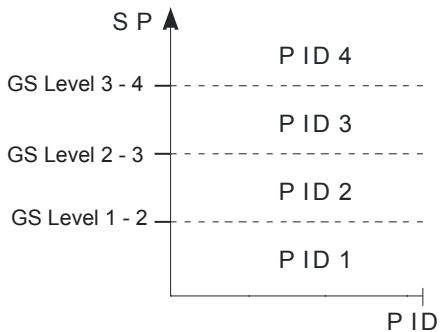

Fig.22. „Gain Scheduling” switched over from SP

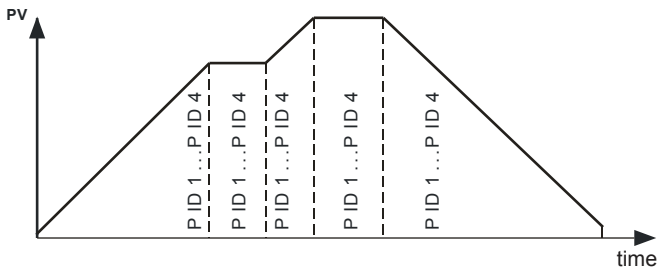

Fig. 23. „Gain Scheduling” switched over for each segment in the programmed control.

10.3. Control range

Control range is defined by [**Ctrl Lim Lo**] and [**Ctrl Lim Hi**] parameters. Control range defines limits for the PID control and auto-tuning algorithm.

10.4. Set value in loop

A set value in loop may be one of the four values defined as SP1, SP2, SP3, SP4, value read from the input 3 or one of the PRG programs.

Soft start

If the value is controlled in loop via SP1, SP2, SP3 or SP4, it is possible to determine an allowable speed of controlled changes (i.e. soft start) during object activation or while changing the set value. It allows for smooth achievement of a target value without re-regulation. When accrual process starts, temporary set value changes from the measured value to the set value allocated to a loop. Selection of the Ramp rate unit between [*rate/min*] and [*rate/h*] is set in the [**Ramp Mode**] parameter, and the Ramp rate in the [**Ramp Rate**] parameter.

10.5. Control algorithms

on-off algorithm

When high accuracy of a temperature control is not required, especially for the high time constant and small delay, it is possible to use on-off control with hysteresis. This method ensures simple and reliable control, its downside is the oscillation, even at low hysteresis values.

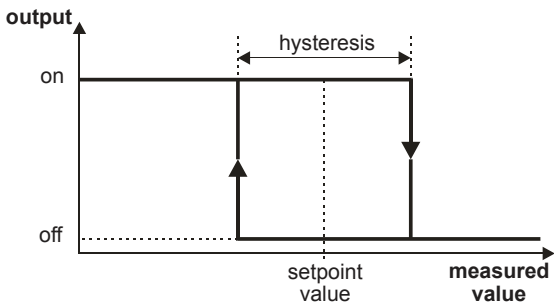

Fig. 24. Heating output operation

SMART PID algorithm

When high precision of the temperature control is necessary, it is recommended to use PID algorithm. Innovative SMART PID algorithm ensures increased precision in the extended range of the control object classes.

Tuning of the controller to object is achieved by manual setting of the proportional term, derivation term or difference term or automatically – by auto-tuning function.

Proceeding in case of a unsatisfactory PID control

PID parameters are best selected by doubling or halving the value. The following rules should be observed during changes:

a) Oscillations

- increase the proportional band,
- increase integration time,
- decrease the differentiation time,

b) Over-regulations

- increase the proportional band,
- increase integration time,
- increase the differentiation time,

c) Instability

- decrease the proportional band,
- decrease the differentiation time,

d) Free jump response:

- decrease the proportional band,
- decrease integration time.

Trace of controlled value	Controller operation algorithms			
	P	PD	PI	PID
	Pb↑	Pb↑ td↓	Pb↑	Pb↑ ti↑ td↓
	Pb↑	Pb↑ td↑	Pb↑ ti↑	Pb↑ ti↑ td↑
		Pb↓ td↓		Pb↓ td↓
	Pb↓	Pb↓	ti↓	Pb↓ ti↓

Fig.25. PID parameters correction method

Auto-tuning

The controller has the function to select PID settings. In most cases these settings ensure an optimal control.

To begin the auto-tuning, one must select the field **[ST]** on the screen of a single loop with fixed set-point control and then press a button **[Exec.]**. For the correct execution of the auto-tuning function, the setting of **[Ctrl Lim Lo]** and **[Ctrl Lim Hi]** parameters is required. The parameter **[Ctrl Lim Lo]** should be set on the value corresponding to the measured value at the switched off control. For object temperature control, one can set 0°C. The parameter **[Ctrl Lim Hi]** should be set on the value corresponding to the maximum measured value when the control is switched on the full power.

Message: SELF symbol in the control status field informs about the activity of the auto-tuning function. The duration of auto-tuning depends on dynamic object properties and can last maximally 10 hours. During auto-tuning or directly after it, over-regulations can occur and because of this, one must set a smaller set point if possible.

The auto-tuning is composed of following stages:

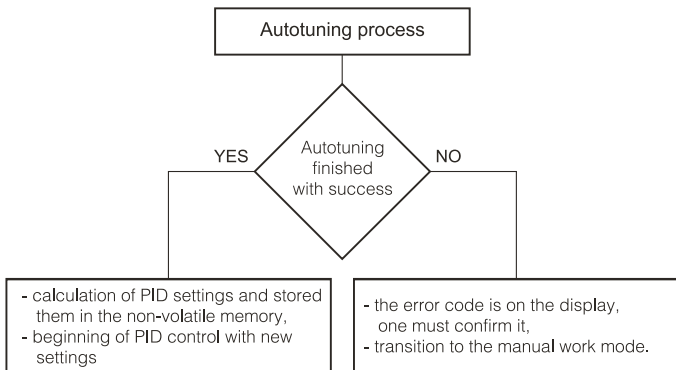

The auto-tuning process will be stopped without counting PID settings, if a supply decay occurs or the field **[ST]** will be again selected and confirmed.

If the auto-tuning is not achieved with success, the error message will be displayed.

Auto-tuning and „Gain Scheduling”

In case, when „Gain Scheduling” is used, one can carry out the auto-tuning in two ways.

The first way consists on choosing a suitable set of PID parameters, in which calculated PID parameters will be stored and realizing the auto-tuning

on the level of the currently chosen set point value for the fixed set point control. One must set the parameter **[GS Type]** in the menu: Loop x → Gain Scheduling to **[Set]**, and select the parameter **[GS Set]** between **[PID1]** and **[PID4]**.

The second way enables an automatic realization of the auto-tuning for all PID sets. One must set the **[GS type]** to **[SP]**, and choose a number of PID sets for setting - the parameter **[GS Level Nb]** Set point values for the individual PID sets must be provided in the parameters **[SP1]**, **[SP2]**, **[SP3]**, **[SP4]** in the menu: Loop x → Set point value from the lowest to the highest.

11. PROGRAMMING CONTROL

11.1. Description of the programming control parameters

List of configuration parameters

Table 3

[Programs] – programs defined for programming control				
[Program 1] - program 1 submenu				
:				
[Program 20] - program 20 submenu				
[Prg.Conf.] - podmenu parametrów programu				
	Symbol of parameter	Parameter description	Factory setting	Parameter modification range
				sensors linear input
	PrgStart	Program start method	Start SP	Start SP: from the value defined by SP0 Start PV: from the current measured value
	SP mode	Initial set value	0,0 °C	MIN...MAX ¹⁾
	Time Unit	Unit of the segment duration time	mm:ss	mm:ss: minutes and seconds hh:mm: hours and minutes
	Ramp Unit	Unit of the set value Ramp rate	Min	Min: minutes Hour: hours
	Holdback Type	Block from the control deviation	Off	Off: inactive Lower: lower Upper: upper Intern.: two-sided

	Cycles Number	Program iteration no.	1	1...999
	Power Fail	Control after supply decay	Continuation	Continuation: program continuation Stop: control stop
	End Type	Program end control	Stop	Stop: control stop Last SP: fixed set-point control with set value from last segment
	Gain Sched.	„Gain Scheduling” function for program	Off	Off: off On: on
[Segment 1] – segment no. 1 parameters submenu				
:				
[Segment 15] – segment no. 15 parameters submenu				
	Symbol of parameter	Parameter description	Factory setting	Parameter modification range
				sensors linear input
	Seg.Type	Segment type	Time	Time: time-defined segment Accrual: accrual-defined segment Hold: set value hold End: program end
	Target SP	Set value at the end of a segment	0,0 °C	MIN...MAX ¹⁾

Seg.Duration	Segment duration	00.01	00.01...99.59 ²⁾	
Ramp Rate	Set value Ramp rate	0.1	0.1...550.0 °C / time unit ⁴⁾ (0.1...990.0 °F / time unit ⁴⁾)	1...5500 °C ³⁾ / time unit ⁴⁾ (1...9900 °F ³⁾ / time unit ⁴⁾)
Holdback Val	Upper control deviation value; after it is exceeded, set value accrual is stopped	0	0.0... 200.0 °C (0.0...360.0 °F)	0...2000 °C ³⁾ (0...3600 °F ³⁾)
Event 1	Event 1 state	Off	Off: off On: on	
Event 2	Event 2 state	Off	Off: off On: on	
Event 3	Event 3 state	Off	Off: off On: on	
Event 4	Event 4 state	Off	Off: off On: on	
Event 5	Event 5 state	Off	Off: off On: on	
Event 6	Event 6 state	Off	Off: off On: on	
PID set	PID set for a segment	PID1	PID1: PID1 PID2: PID2 PID3: PID3 PID4: PID4	

1) See TBD table.

2) Time unit is defined by the [Time unit] parameter

3) Resolution of the parameter depends on the [Dot.pos,] parameter, i.e. position of the decimal point.

4) Ramp unit is defined by the [Ramp Unit] parameter

11.2. Defining the set value programs

Up to 20 programs may be defined. One program may include up to 15 sections.

To ensure that parameters related to the programming control are displayed in the menu, a **[SP Mode]** parameter must be set to *[PRG]*. Every program must have parameters set in the program parameters submenu. For every segment, select a segment type and proper parameters according to the segment type, as indicated in the table 4.

List of segment configuration parameters

Table 4

[Seg.Type] = <i>[Time]</i>	[Seg.Type] = <i>[Rate]</i>	[Seg.Type] = <i>[Dwell]</i>	[Seg.Type] = <i>[End]</i>
Target SP	Target SP	Segment time	
Segment time	Ramp rate		
Holdback Val	Holdback Val		

Picture 22 and table 5 show an example of set value program. The program assumes that the object temperature should increase from initial temperature to 800°C with a rate of 20°C per minute with active deviation block.

The temperature is then maintained for 120 minutes (block disengaged), and then drops to 50°C through 100 minutes (block disengaged); during object cooling it is necessary to engage the fan connected to the output 2 (in Outputs → Output2 menu: **[Function]** parameter set to *[Prg Eventf]* and **[Prg Event]** parameter set to *[SegEvent1]*).

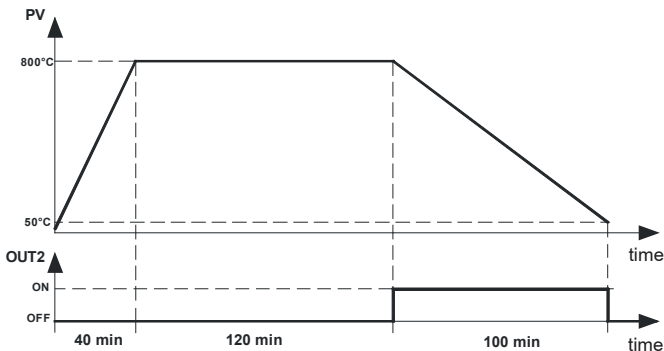

Fig.26. Example program

Parameter value for the example program

Table 5

	Parameter	Value	Meaning
Config. Prg	PrgStart	<i>Start PV</i>	Set value accrual start from the initial (current) temperature
	Time Unit	<i>hh:mm</i>	The unit of time: hours and minutes
	Ramp Unit	<i>Min</i>	Ramp rate unit: minutes
	Holdback Val	<i>Intern.</i>	Program block active - double-sided
	Cycles Number	<i>1</i>	Program iteration no.
	Power Fail	<i>Continuation</i>	Program continuation after supply decay
	End Type	<i>Stop</i>	Control end after program closes

Segment 1	Seg.Type	<i>Accrual</i>	Segment type: Ramp rate
	Target SP	800	Target set value: 800.0 °C
	Ramp rate	20	Ramp rate 20.0 °C / minute
	Holdback Val	50	Block active when deviation is higher than 50.0 °C
	Event 1	Off	Events 1 on output 2: off
Segment 2	Segment type	<i>Segment time</i>	Section type: segment duration time
	Segment time	02.00	Segment time 2h00 = 120 minutes
	Event 1	Off	Events 1 on output 2: off
Segment 3	Segment type	<i>Segment time</i>	Section type: segment duration time
	Target SP	50	Target set value: 50.0 °C
	Segment time	01.40	Segment time 1h40 = 100 minutes
	Holdback Val	0	Block inactive
	Event 1	On	Events 1 on output 2: on
Segment 4	Segment type	<i>End</i>	Section type: program end
	Event1	Off	Events 1 on output 2: on

12. MODBUS PROTOCOL

12.1. Introduction

RE92 controller is equipped with RS-485 serial interface with implemented MODBUS protocol.

Summary of the RE92 controller Modbus protocol:

- device address: 1..247,
- baud rate: 4800, 9600, 19200, 38400, 57600 bit/s, 115200 bit/s
- operation modes: RTU,
- mode: 8N2, 8E1, 8O1, 8N1,
- maximum response time: 500 ms,
- data format: float (2x16 bits),
- maximum number of registers read/written in one command: 126.

In case of Modbus TCP slave, the parameters such as device address, baud rate, operating mode, information unit, maximal response time are not used. Additionally a port is set by default at 502.

Registers addresses are identical for Modbus slave and Modbus TCP slave.

RE92 controller uses following protocol functions:

Table 6

Code	Meaning
3	n-registers read
6	1 register write
16	n-registers write
17	slave device identification

12.2. Error codes

If the controller receives query with the transmission error or checksum error, then such query will be ignored. When a query with correct syntax and invalid values is found, the controller returns an error code.

Table 7 shows error codes and their meaning.

Error codes

Table 7

Code	Meaning	Cause
01	illegal function	function is not handled by the controller
02	illegal data address	register address out of range
03	illegal data value	register value out of range or register is readout only

12.3. Register map

Register groups map

Table 8

Address range	Value type	Description
4000 – 4099	integer (16 bits)	value set in the 16-bit register
7000 – 7099	float (2x16 bits)	value set in the two subsequent 16-bit registers, readout only registers
7100 – 7499	float (2x16 bits)	value set in the two subsequent 16-bit registers, readout and write registers
7600 – 12000	float (2x16 bits)	value set in the two subsequent 16-bit registers, readout and write registers

Register address	Marking	Operations	Parameter range	Description
4000		-W	1...11	Command register 1 – switch to manual operation in loop 1 2 – switch to manual operation in loop 2 3 – switch from manual operation to automatic control in loop 1 4 – switch from manual operation to automatic control in loop 2 5 – start auto-tuning in loop 1 6 – start auto-tuning in loop 2 7 – stop auto-tuning in loop 1 8 – stop auto-tuning in loop 2 9 – alarm reset 10 – revert to default settings (with exception of Ethernet group and defined programs) 11 – revert defined programs to default settings
4001		R-	100...999	Loader version number [x100]
4002		R-	10000...65000	Loader version number [x10000]

4003		R-		<p>Controller manufacture code</p> <p>bit 1 0 – INPUT 3: 0 0 – input 3 – none 1 0 – output 3 – current 0/4–20 mA 1 1 – output 3 – voltage 0–10 V</p> <p>bit 3 2 – OUTPUT 1 and 2: 0 1 – output 1 and 2 – relay 1 0 – output 1 and 2 – 0/5 V</p> <p>bit 4 – ANALOG OUTPUTS 0 0 – analog output - none 0 1 – analog output - 2</p>
4004		R-	0...0xFFFF	Controller status – description in table 10
4005		R-	0...0xFFFF	Alarm status – description in table 11
4006		R-	0...0xFFFF	Error status – description in table 12
4007		RW	-1000...1000	Controlling signal from loop 1 [x10] (for writing during manual operation)
4008		RW	-1000...1000	Controlling signal from loop 2 [x10] (for writing during manual operation)
4009		RW	0...2359	Current time – format: hour * 100 + minutes
4010		RW	0...59	Current time – seconds
4011		RW	101...1231	Current date – format: month * 100 + day
4012		RW	2000...2099	Current date – year
4013		R-	1201...9999	Serial number (older part)
4014		R-	1...9999	Serial number (younger part)
4015		R-	0...0x7FFF	Status of timer 1...3 (see Tab.13)

4016		R-	0...0x7FFF	Status of timer 4...6 (see Tab.14)
4017		RW	0...1	Switching off/on the timer 1 0 – timer off 1 – timer on
4018		RW	0...1	Switching off/on the timer 2 0 – timer off 1 – timer on
4019		RW	0...1	Switching off/on the timer 3 0 – timer off 1 – timer on
4020		RW	0...1	Switching off/on the timer 4 0 – timer off 1 – timer on
4021		RW	0...1	Switching off/on the timer 5 0 – timer off 1 – timer on
4022		RW	0...1	Switching off/on the timer 6 0 – timer off 1 – timer on
4023		RW	0...1	Latch type of the timer 1 output 0 – continuous latch 1 – timer latch
4024		RW	0...1	Latch type of the timer 2 output 0 – continuous latch 1 – timer latch
4025		RW	0...1	Latch type of the timer 3 output 0 – continuous latch 1 – timer latch
4026		RW	0...1	Latch type of the timer 4 output 0 – continuous latch 1 – timer latch
4027		RW	0...1	Latch type of the timer 5 output 0 – continuous latch 1 – timer latch
4028		RW	0...1	Latch type of the timer 6 output 0 – continuous latch 1 – timer latch

4029		RW	0...1	Alarm type of timer 1 0 – absolute upper 1 – absolute lower
4030		RW	0...1	Alarm type of timer 2 0 – absolute upper 1 – absolute lower
4031		RW	0...1	Alarm type of timer 3 0 – absolute upper 1 – absolute lower
4032		RW	0...1	Alarm type of timer 4 0 – absolute upper 1 – absolute lower
4033		RW	0...1	Alarm type of timer 5 0 – absolute upper 1 – absolute lower
4034		RW	0...1	Alarm type of timer 6 0 – absolute upper 1 – absolute lower

Register 4004 – controller status

Table 10

bit	Description
0	Input 1 measuring value out of measurement range
1	Input 2 measuring value out of measurement range
2	Input 3 measuring value out of measurement range
3	Loop 1 measuring value out of measurement range
4	Loop 2 measuring value out of measurement range
5	Manual operation in loop 1: 1 – active, 0 – inactive
6	Manual operation in loop 2: 1 – active, 0 – inactive
7	Auto-tuning in loop 1: 1 – active, 0 – inactive
8	Auto-tuning in loop 2: 1 – active, 0 – inactive
9	Auto-tuning in loop 1 failed
10	Auto-tuning in loop 2 failed

11	Soft start in loop 1: 1 – active, 0 – inactive
12	Soft start in loop 2: 1 – active, 0 – inactive
13-14	Reserved
15	Controller error – check the error register

Register 4005 – alarm state

Table 11

bit	Description
0	State of the alarm 1.:1 – active, 0 – inactive
1	Status of the alarm 2.:1 – active, 0 – inactive
2	Status of the alarm 3.:1 – active, 0 – inactive
3	Status of the alarm 4.:1 – active, 0 – inactive
4	Status of the alarm 5.:1 – active, 0 – inactive
5	Status of the alarm 6.:1 – active, 0 – inactive
6-15	Reserved

Register 4006 – error register

Table 12

bit	Description
0	Uncalibrated input 1
1	Uncalibrated input 2
2	Uncalibrated input 3
2	Uncalibrated input 1 (current)
3	Uncalibrated input 1 (voltage)
4	Uncalibrated input 2 (current)
5	Uncalibrated input 2 (voltage)
6-14	Reserved
15	Controller memory checksum error

Register 4015 – status of the timers 1..3

Table 13

bit	Description
4...0	Timer 1 x00000 – other statuses x00001 – timer enabled waiting for event x00010 – countdown x00100 – timer pause x01000 – end of the countdown x10000 – alarm timer on (output actuated)
9...5	Timer 2 x00000 – other statuses x00001 – timer enabled waiting for event x00010 – countdown x00100 – timer pause x01000 – end of the countdown x10000 – alarm timer on (output actuated)
14...10	Timer 3 x00000 – other statuses x00001 – timer enabled waiting for event x00010 – countdown x00100 – timer pause x01000 – end of the countdown x10000 – alarm timer on (output actuated)
15	Reserved

Register 4016 – status of the timers 4..6

Table 14

bit	Description
4...0	Timer 4 x00000 – other statuses x00001 – timer enabled waiting for event x00010 – countdown x00100 – timer pause x01000 – end of the countdown x10000 – alarm timer on (output actuated)

9...5	<p>Timer 5</p> <p>x00000 – other statuses</p> <p>x00001 – timer enabled waiting for event</p> <p>x00010 – countdown</p> <p>x00100 – timer pause</p> <p>x01000 – end of the countdown</p> <p>x10000 – alarm timer on (output actuated)</p>
14...10	<p>Timer 6</p> <p>x00000 – other statuses</p> <p>x00001 – timer enabled waiting for event</p> <p>x00010 – countdown</p> <p>x00100 – timer pause</p> <p>x01000 – end of the countdown</p> <p>x10000 – alarm timer on (output actuated)</p>
15	Reserved

Map of the registers from address 7000

Table 15

Register address	Operations	Description
7000	R	Measuring value at input 1
7002	R	Measuring value at input 2
7004	R	Measuring value at input 3
7006	R	Measuring value in loop 1
7008	R	Set point value in loop 1
7010	R	Loop 1 controlling signal in loop 1
7012	R	Loop 2 controlling signal in loop 1
7014	R	Measuring value in loop 2
7016	R	Set point value in loop 2
7018	R	Loop 1 controlling signal in loop 2
7020	R	Loop 2 controlling signal in loop 2

7058	R	Time to switch on the alarm timer 1
7060	R	Time to switch on the alarm timer 2
7062	R	Time to switch on the alarm timer 3
7064	R	Time to switch on the alarm timer 4
7066	R	Time to switch on the alarm timer 5
7068	R	Time to switch on the alarm timer 6
7070	R	Time to switch off the alarm timer 1 latch
7072	R	Time to switch off the alarm timer 2 latch
7074	R	Time to switch off the alarm timer 3 latch
7076	R	Time to switch off the alarm timer 4 latch
7078	R	Time to switch off the alarm timer 5 latch
7080	R	Time to switch off the alarm timer 6 latch

Map of the registers from address 7100

Table 16

Register address	Operations	Parameter range	Description
7100	RW	0...18	Type of input no. 1: 0 – thermoresistor Pt100 1 – thermoresistor Pt500 2 – thermoresistor Pt1000 3 – thermoresistor Ni100 4 – thermoresistor Ni1000 5 – thermoresistor Cu100 6 – J type thermocouple 7 – T type thermocouple 8 – K type thermocouple

			<p>9 – S type thermocouple 10 – R type thermocouple 11 – B type thermocouple 12 – E type thermocouple 13 – N type thermocouple 14 – L type thermocouple 15 – current input 0-20 mA 16 – current input 4-20 mA 17 – voltage input 0-5 V 18 – voltage input 0-10 V</p>
7102	RW	0...2	<p>Unit of input no 1: 0 – degrees Celsius 1 – degrees Fahrenheit 2 – physical units</p>
7104	RW	0...1 ^{3) 4)} 0...2 ⁵⁾	<p>Decimal point position for input 1: 0 – without a decimal place 1 – 1 decimal place 2 – 2 decimal places</p>
7106	RW	0...1	<p>Compensation of thermocouple cold terminals for input 1: 0 – automatic 1 – manual</p>
7108	RW	0...50.0	<p>Cold terminals temperature with manual compensation for input 1</p>
7110	RW	-9999...99999	<p>Indication for the lower limit for input 1 (linear input)</p>
7112	RW	-9999...99999	<p>Indication for the upper limit for input 1 (linear input)</p>
7114	RW	-35.00...35.00	<p>Measured value shift for input 1</p>
7116	RW	0...9	<p>Digital filter of input no 1: 0 – filter off 1 – time constant 0.2 s 2 – time constant 0.5 s 3 – time constant 1 s 4 – time constant 2 s 5 – time constant 5 s 6 – time constant 10 s 7 – time constant 20 s 8 – time constant 50 s 9 – time constant 100 s</p>

7118	RW	0...18	Type of input no. 2: 0 – thermoresistor Pt100 1 – thermoresistor Pt500 2 – thermoresistor Pt1000 3 – thermoresistor Ni100 4 – thermoresistor Ni1000 5 – thermoresistor Cu100 6 – J type thermocouple 7 – T type thermocouple 8 – K type thermocouple 9 – S type thermocouple 10 – R type thermocouple 11 – B type thermocouple 12 – E type thermocouple 13 – N type thermocouple 14 – L type thermocouple 15 – current input 0-20 mA 16 – current input 4-20 mA 17 – voltage input 0-5 V 18 – voltage input 0-10 V
7120	RW	0...2	Unit of input no 2: 0 – degrees Celsius 1 – degrees Fahrenheit 2 – physical units
7122	RW	0...1 ^{3) 4)} 0...2 ⁵⁾	Decimal point position for input 2: 0 – without a decimal place 1 – 1 decimal place 2 – 2 decimal places
7124	RW	0...1	Compensation of thermocouple cold terminals for input 2: 0 – automatic 1 – manual
7126	RW	0...50.0	Cold terminals temperature with manual compensation for input 2
7128	RW	-9999...99999	Indication for the lower limit for input 2 (linear input)
7130	RW	-9999...99999	Indication for the upper limit for input 2 (linear input)
7132	RW	-35.00...35.00	Measured value shift for input 2

7134	RW	0...9	Digital filter of input no 2: 0 – filter off 1 – time constant 0.2 s 2 – time constant 0.5 s 3 – time constant 1 s 4 – time constant 2 s 5 – time constant 5 s 6 – time constant 10 s 7 – time constant 20 s 8 – time constant 50 s 9 – time constant 100 s
7136	RW	0...6	Type of input no. 3: 0 – none 1 – current input 0-20 mA 2 – current input 4-20 mA 3 – voltage input 0-5 V 4 – voltage input 0-10 V 5 – potentiometric input 100 Ohm 6 – potentiometric input 1000 Ohm
7138	RW	0...2	Unit of input no 3: 0 – degrees Celsius 1 – degrees Fahrenheit 2 – physical units
7140	RW	0...1 ^{3) 4)} 0...2 ⁵⁾	Decimal point position for input 3: 0 – without a decimal place 1 – 1 decimal place 2 – 2 decimal places
7142	RW	-9999...99999	Indication for the lower limit for input 3 (linear input)
7144	RW	-9999...99999	Indication for the upper limit for input 3 (linear input)
7146	RW	-35.00...35.00	Measured value shift for input 3
7148	RW	0...9	Digital filter of input no 3: 0 – filter off 1 – time constant 0.2 s 2 – time constant 0.5 s 3 – time constant 1 s 4 – time constant 2 s 5 – time constant 5 s

			<ul style="list-style-type: none"> 6 – time constant 10 s 7 – time constant 20 s 8 – time constant 50 s 9 – time constant 100 s
7150	RW	0...10	<p>Function of binary input 1:</p> <ul style="list-style-type: none"> 0 – none 1 – stop automatic control 2 – switch to manual operation 3 – switches to subsequent SP 4 – program start 5 – jump to the next segment 6 – stops the incrementing of the set value in program 7 – end of the program 8 – stop of the program with possible continuation 9 – stop the program and jump to the beginning 10 – switching to subsequent SP from the additional input - IN3 11 – alarm reset of timer 1 12 – alarm reset of timer 2 13 – alarm reset of timer 3 14 – alarm reset of timer 4 15 – alarm reset of timer 5 16 – alarm reset of timer 6 17 – switching to SP from the input 1 18 – switching to SP from the input 2
7152	RW	0...10	<p>Function of binary input 2:</p> <ul style="list-style-type: none"> 0 – none 1 – stop automatic control 2 – switch to manual operation 3 – switches to subsequent SP 4 – program start 5 – jump to the next segment 6 – stops the incrementing of the set value in program 7 – end of the program 8 – stop of the program with possible continuation 9 – stop the program and jump to the beginning 10 – switching to subsequent SP from the additional input - IN3

			<ul style="list-style-type: none"> 11 – alarm reset of timer 1 12 – alarm reset of timer 2 13 – alarm reset of timer 3 14 – alarm reset of timer 4 15 – alarm reset of timer 5 16 – alarm reset of timer 6 17 – switching to SP from the input 1 18 – switching to SP from the input 2
7154	RW	0...10	<p>Function of binary input 3:</p> <ul style="list-style-type: none"> 0 – none 1 – stop automatic control 2 – switch to manual operation 3 – switches to subsequent SP 4 – program start 5 – jump to the next segment 6 – stops the incrementing of the set value in program 7 – end of the program 8 – stop of the program with possible continuation 9 – stop the program and jump to the beginning 10 – switching to subsequent SP from the additional input - IN3 11 – alarm reset of timer 1 12 – alarm reset of timer 2 13 – alarm reset of timer 3 14 – alarm reset of timer 4 15 – alarm reset of timer 5 16 – alarm reset of timer 6 17 – switching to SP from the input 1 18 – switching to SP from the input 2
7156	RW	0...12	<p>Allocation of output 1:</p> <ul style="list-style-type: none"> 0 – none 1 – loop 1 2 – loop 2 3 – input 1 4 – input 2 5 – input 3 6 – input 1 + input 2 + input 3 7 – binary input 1 8 – binary input 2 9 – binary input 3

			10 – inverted binary input 1 11 – inverted binary input 2 12 – inverted binary input 3
7158	RW	0...7	Output 1 function: 0 – none 1 – heating 2 – cooling 3 – opening a valve 4 – closing a valve 5 – alarm 1 6 – programming control event 7 – slave loop signal by cascade control 8 – timer 1 alarm
7160	RW	0...7	Output 1 program event: 0 – none 1 – event 1 from a segment 2 – event 2 from a segment 3 – event 3 from a segment 4 – event 4 from a segment 5 – event 5 from a segment 6 – event 6 from a segment 7 – deviation block
7162	RW	0.5...99.9	Output 1 imp. period
7164	RW	0...12	Allocation of output 2: 0 – none 1 – loop 1 2 – loop 2 3 – input 1 4 – input 2 5 – input 3 6 – input 1 + input 2 + input 3 7 – binary input 1 8 – binary input 2 9 – binary input 3 10 – inverted binary input 1 11 – inverted binary input 2 12 – inverted binary input 3

7166	RW	0...7	Output 2 function: 0 – none 1 – heating 2 – cooling 3 – opening a valve 4 – closing a valve 5 – alarm 2 6 – programming control event 7 – slave loop signal by cascade control 8 – timer 2 alarm
7168		0...7	Output 2 program event: 0 – none 1 – event 1 from a segment 2 – event 2 from a segment 3 – event 3 from a segment 4 – event 4 from a segment 5 – event 5 from a segment 6 – event 6 from a segment 7 – deviation block
7170	RW	0.5...99.9	Output 2 imp. period
7172	RW	0...12	Allocation of input 3: 0 – none 1 – loop 1 2 – loop 2 3 – input 1 4 – input 2 5 – input 3 6 – input 1 + input 2 + input 3 7 – binary input 1 8 – binary input 2 9 – binary input 3 10 – inverted binary input 1 11 – inverted binary input 2 12 – inverted binary input 3
7174	RW	0...7	Output 3 function: 0 – none 1 – heating 2 – cooling 3 – opening a valve 4 – closing a valve 5 – alarm 3 6 – programming control event 7 – slave loop signal by cascade control 8 – timer 3 alarm

7176		0...7	Output 3 program event: 0 – none 1 – event 1 from a segment 2 – event 2 from a segment 3 – event 3 from a segment 4 – event 4 from a segment 5 – event 5 from a segment 6 – event 6 from a segment 7 – deviation block
7178	RW	0.5...99.9	Output 3 imp. period
7180	RW	0...12	Allocation of input 4: 0 – none 1 – loop 1 2 – loop 2 3 – input 1 4 – input 2 5 – input 3 6 – input 1 + input 2 + input 3 7 – binary input 1 8 – binary input 2 9 – binary input 3 10 – inverted binary input 1 11 – inverted binary input 2 12 – inverted binary input 3
7182	RW	0...7	Output 4 function: 0 – none 1 – heating 2 – cooling 3 – opening a valve 4 – closing a valve 5 – alarm 4 6 – programming control event 7 – slave loop signal by cascade control 8 – timer 4 alarm
7184		0...7	Output 4 program event: 0 – none 1 – event 1 from a segment 2 – event 2 from a segment 3 – event 3 from a segment 4 – event 4 from a segment 5 – event 5 from a segment 6 – event 6 from a segment 7 – deviation block

7186	RW	0.5...99.9	Output 4 imp. period
7188	RW	0...12	Allocation of input 5: 0 – none 1 – loop 1 2 – loop 2 3 – input 1 4 – input 2 5 – input 3 6 – input 1 + input 2 + input 3 7 – binary input 1 8 – binary input 2 9 – binary input 3 10 – inverted binary input 1 11 – inverted binary input 2 12 – inverted binary input 3
7190	RW	0...7	Output 5 function: 0 – none 1 – heating 2 – cooling 3 – opening a valve 4 – closing a valve 5 – alarm 5 6 – programming control event 7 – slave loop signal by cascade control 8 – timer 5 alarm
7192		0...7	Output 5 program event: 0 – none 1 – event 1 from a segment 2 – event 2 from a segment 3 – event 3 from a segment 4 – event 4 from a segment 5 – event 5 from a segment 6 – event 6 from a segment 7 – deviation block
7194	RW	0.5...99.9	Output 5 imp. period
7196	RW	0...12	Allocation of input 6: 0 – none 1 – loop 1 2 – loop 2 3 – input 1 4 – input 2

			<ul style="list-style-type: none"> 5 – input 3 6 – input 1 + input 2 + input 3 7 – binary input 1 8 – binary input 2 9 – binary input 3 10 – inverted binary input 1 11 – inverted binary input 2 12 – inverted binary input 3
7198		0...7	<p>Output 6 function:</p> <ul style="list-style-type: none"> 0 – none 1 – heating 2 – cooling 3 – opening a valve 4 – closing a valve 5 – alarm 6 6 – programming control event 7 – slave loop signal by cascade control 8 – timer 6 alarm
7200	RW	0...7	<p>Output 6 program event:</p> <ul style="list-style-type: none"> 0 – none 1 – event 1 from a segment 2 – event 2 from a segment
			<ul style="list-style-type: none"> 3 – event 3 from a segment 4 – event 4 from a segment 5 – event 5 from a segment 6 – event 6 from a segment 7 – deviation block
7202	RW	0.5...99.9	Output 6 imp. period
7204	RW	0...6	<p>Allocation of analog output 1:</p> <ul style="list-style-type: none"> 0 – none 1 – loop 1 2 – loop 2 3 – input 1 4 – input 2 5 – input 3 6 – input 1 + input 2 + input 3

7206	RW	0...3	Linear output 1 function: 0 – none 1 – heating 2 – cooling 3 – retransmission
7208	RW	0...2	Analog output 1 retransmission source: 0 – measuring value 1 – set value 2 – set value – measuring value
7210	RW	-9999...99999	Min for retr. of analog output 1
7212	RW	-9999...99999	Max for retr. of analog output 1
7214	RW	0...2	I-output type for analog output 1: 0 – none 1 – 4...20 mA 2 – 0...20 mA
7216	RW	0...2	U-output type for analog output 1: 0 – none 1 – 0...5 V 2 – 0...10 V
7218	RW	0...6	Allocation of analog output 2: 0 – none 1 – loop 1 2 – loop 2 3 – input 1
			4 – input 2 5 – input 3 6 – input 1 + input 2 + input 3
7220	RW	0...3	Linear output 2 function: 0 – none 1 – heating 2 – cooling 3 – retransmission
7222	RW	0...2	Analog output 2 retransmission source: 0 – measuring value 1 – set point value 2 – set point value – measuring value
7224	RW	-9999...99999	Min for retr. of analog output 2

7226	RW	-9999...99999	Max for retr. of analog output 2
7228	RW	0...2	I-output type for analog output 2: 0 – none 1 – 4...20 mA 2 – 0...20 mA
7230	RW	0...2	U-output type for analog output 2: 0 – none 1 – 0...5 V 2 – 0...10 V
7232	RW	0...5	Measuring value in loop 1: 0 – input 1 1 – input 2 2 – input 3 3 – input 1 + input 2 4 – input 1 + input 3 5 – input 2 + input 3
7234	RW	-10.0...10.0	Input 1 coefficient in loop 1
7236	RW	-10.0...10.0	Input 2 coefficient in loop 1
7238	RW	-10.0...10.0	Input 3 coefficient in loop 1
7240	RW	0...7	Binary inputs in loop 1: 0 – none 1 – binary input 1 2 – binary input 2
			3 – binary input 3 4 – binary input 1 and 2 5 – binary input 1 and 3 6 – binary input 2 and 3 7 – binary input 1, 2 and 3
7242	RW	0...5	SP type in loop 1: 0 – SP1 set point value 1 – SP2 set point value 2 – SP3 set point value 3 – SP4 set point value 4 – set point value from input 3 5 – set point value from program 6 – set point value from input 1 7 – set point value from input 2

7244	RW	0...9	Program number on loop 1: 0 – program number 1 1 – program number 2 2 – program number 3 3 – program number 4 4 – program number 5 5 – program number 6 6 – program number 7 7 – program number 8 8 – program number 9 9 – program number 10
7246	RW	-9999...99999	SP1 set value in loop 1
7248	RW	-9999...99999	SP2 set value in loop 1
7250	RW	-9999...99999	SP3 set value in loop 1
7252	RW	-9999...99999	SP4 set value in loop 1
7254	RW	-9999...99999	SP setting lower limit in loop 1
7256	RW	-9999...99999	SP setting upper limit in loop 1
7258	RW	0...2	Set value accrual in loop 1: 0 – off 1 – accrual in units / minute 2 – accrual in units / hour
7260	RW	-9999...99999	Set value Ramp rate in loop 1
7262	RW	0...5	Control type in loop 1: 0 – control off 1 – heating-type control 2 – cooling-type control 3 – heating-cooling control 4 – step-by-step valve control 5 – step-by-step feedback valve control
7264	RW	0...1	Control algorithm in loop 1: 0 – on-off algorithm 1 – PID algorithm
7266	RW	0,1...100,0	Hysteresis in loop 1
7268	RW	-99.9...99.9	Distance range in loop 1
7270	RW	-100.0...100.0	Control signal in loop 1

7272	RW	-9999...99999	Control lower limit in loop 1
7274	RW	-9999...99999	Control upper limit in loop 1
7276	RW	0...550.0 [°C] 0...990.0 [°F]	PID1 set proportional band in loop 1
7278	RW	0...9999	Integration time constant [s] from PID1 set in the loop 1
7280	RW	0.0...2500.0	Differentiation time constant [s] from PID1 set in the loop 1
7282	RW	0.0...100.0	Control signal correction for P or PD of PID1 set in loop 1
7284	RW	0...550.0 [°C] 0...990.0 [°F]	PID2 set proportional band in loop 1
7286	RW	0...9999	Integration time constant [s] from PID2 set in the loop 1
7288	RW	0.0...2500.0	Differentiation time constant [s] from PID2 set in the loop 1
7290	RW	0.0...100.0	Control signal correction for P or PD of PID2 set in loop 1
7292	RW	0...550.0 [°C] 0...990.0 [°F]	PID3 set proportional band in loop 1
7294	RW	0...9999	Integration time constant [s] from PID3 set in the loop 1
7296	RW	0.0...2500.0	Differentiation time constant [s] from PID3 set in the loop 1
7298	RW	0.0...100.0	Control signal correction for P or PD of PID3 set in loop 1
7300	RW	0...550.0 [°C] 0...990.0 [°F]	PID4 set proportional band in loop 1
7302	RW	0...9999	Integration time constant [s] from PID4 set in the loop 1
7304	RW	0.0...2500.0	Differentiation time constant [s] from PID4 set in the loop 1

7306	RW	0.0...100.0	Control signal correction for P or PD of PID4 set in loop 1
7308	RW	0.1...200.0 [%]	Proportional band of cooling loop in loop 1
7310	RW	0...9999	Integration time constant [s] of cooling loop in the loop 1
7312	RW	0.0...2500.0	Differentiation time constant [s] of cooling loop in the loop 1
7314	RW	0...2	„Gain Scheduling” function in loop 1: 0 – off 1 – switched according to set value 2 – selected fixed PID set
7316	RW	0...2	Number of PID sets for Gain Scheduling, switched according to the value set in loop 1: 0 – 2 PID sets used 1 – 3 PID sets used 2 – 4 PID sets used
7318	RW	-9999...99999	Switching level for PID1 and PID2 set, switched as per value set in loop 1
7320	RW	-9999...99999	Switching level for PID2 and PID3 set, switched as per value set in loop 1
7322	RW	-9999...99999	Switching level for PID3 and PID4 set, switched as per value set in loop 1
7324	RW	0...3	Fixed PID set for Gain Scheduling in loop 1: 0 – PID1 set 1 – PID2 set 2 – PID3 set 3 – PID4 set
7326	RW	0...5	Measuring value in loop 2: 0 – input 1 1 – input 2 2 – input 3 3 – input 1 + input 2 4 – input 1 + input 3 5 – input 2 + input 3

7328	RW	-10.0...10.0	Input 1 coefficient in loop 2
7330	RW	-10.0...10.0	Input 2 coefficient in loop 2
7332	RW	-10.0...10.0	Input 3 coefficient in loop 2
7334	RW	0...7	Binary inputs in loop 2: 0 – none 1 – binary input 1 2 – binary input 2 3 – binary input 3 4 – binary input 1 and 2 5 – binary input 1 and 3 6 – binary input 2 and 3 7 – binary input 1, 2 and 3
7336	RW	0...5	SP type in loop 2: 0 – SP1 set point value 1 – SP2 set point value 2 – SP3 set point value 3 – SP4 set point value 4 – set point value from input 3 5 – set point value from program 6 – set point value from input 1 7 – set point value from input 2
7338	RW	10...19	Program number on loop 2: 10 – program number 11 11 – program number 12 12 – program number 13 13 – program number 14 14 – program number 15 15 – program number 16 16 – program number 17 17 – program number 18 18 – program number 19 19 – program number 20
7340	RW	-9999...99999	SP1 set value in loop 2
7342	RW	-9999...99999	SP2 set value in loop 2
7344	RW	-9999...99999	SP3 set value in loop 2
7346	RW	-9999...99999	SP4 set value in loop 2
7348	RW	-9999...99999	SP setting lower limit in loop 2

7350	RW	-9999...99999	SP setting upper limit in loop 2
7352	RW	0...2	Set value accrual in loop 2: 0 – off 1 – accrual in units / minute 2 – accrual in units / hour
7354	RW	-9999...99999	Set value Ramp rate in loop 2
7356	RW	0...5	Control type in loop 2: 0 – control off 1 – heating-type control 2 – cooling-type control 3 – heating-cooling control 4 – step-by-step valve control 5 – step-by-step feedback valve control 6 – cascade control
7358	RW	0...1	Control algorithm in loop 2: 0 – on-off algorithm 1 – PID algorithm
7360	RW	0.1...100.0	Hysteresis in loop 2
7362	RW	-99.9...99.9	Distance range in loop 2
7364	RW	-100.0...100.0	Control signal in loop 2
7366	RW	-9999...99999	Control lower limit in loop 2
7368	RW	-9999...99999	Control upper limit in loop 2
7370	RW	0...550.0 [°C] 0...990.0 [°F]	PID1 set proportional band in loop 2
7372	RW	0...9999	Integration time constant [s] from PID1 set in the loop 2
7374	RW	0.0...2500.0	Differentiation time constant [s] from PID1 set in the loop 2
7376	RW	0.0...100.0	Control signal correction for P or PD of PID1 set in loop 2
7378	RW	0...550.0 [°C] 0...990.0 [°F]	PID2 set proportional band in loop 2

7380	RW	0...9999	Integration time constant [s] from PID2 set in the loop 2
7382	RW	0.0...2500.0	Differentiation time constant [s] from PID2 set in the loop 2
7384	RW	0.0...100.0	Control signal correction for P or PD of PID2 set in loop 2
7386	RW	0...550.0 [°C] 0...990.0 [°F]	PID3 set proportional band in loop 2
7388	RW	0...9999	Integration time constant [s] from PID3 set in the loop 2
7390	RW	0.0...2500.0	Differentiation time constant [s] from PID3 set in the loop 2
7392	RW	0.0...100.0	Control signal correction for P or PD of PID3 set in loop 2
7394	RW	0...550.0 [°C] 0...990.0 [°F]	PID4 set proportional band in loop 2
7396	RW	0...9999	Integration time constant [s] from PID4 set in the loop 2
7398	RW	0.0...2500.0	Differentiation time constant [s] from PID4 set in the loop 2
7400	RW	0.0...100.0	Control signal correction for P or PD of PID4 set in loop 2
7402	RW	0.1...200.0 [%]	Proportional band of cooling loop in loop 2
7404	RW	0...9999	Integration time constant [s] of cooling loop in the loop 2
7406	RW	0.0...2500.0	Differentiation time constant [s] of cooling loop in the loop 2
7408	RW	0...2	Gain Scheduling function in loop 2: 0 – off 1 – switched according to set value 2 – selected fixed PID set

7410	RW	0...2	Number of PID sets for Gain Scheduling, switched according to the value set in loop 2: 0 – 2 PID sets used 1 – 3 PID sets used 2 – 4 PID sets used
7412	RW	-9999...99999	Switching level for PID1 and PID2 set, switched as per value set in loop 2
7414	RW	-9999...99999	Switching level for PID2 and PID3 set, switched as per value set in loop 2
7416	RW	-9999...99999	Switching level for PID3 and PID4 set, switched as per value set in loop 2
7418	RW	0...3	Fixed PID set for Gain Scheduling in loop 2: 0 – PID1 set 1 – PID2 set 2 – PID3 set 3 – PID4 set
7420	RW	0...5	Alarm type 1: 0 – absolute upper 1 – absolute lower 2 – relative upper 3 – relative lower 4 – relative internal 5 – relative internal
7422	RW	-9999...99999	Alarm 1 set value
7424	RW	-9999...99999	Alarm 1 deviation (for relative alarms)
7426	RW	0.1...99.9	Alarm 1 hysteresis
7428	RW	0...1	Memory of the alarm 1: 0 – off 1 – on
7430	RW	0...5	Alarm type 2: 0 – absolute upper 1 – absolute lower 2 – relative upper 3 – relative lower 4 – relative internal 5 – relative internal

7432	RW	-9999...99999	Alarm 2 set point value
7434	RW	-9999...99999	Alarm 2 deviation (for relative alarms)
7436	RW	0.1...99.9	Alarm 2 hysteresis
7438	RW	0...1	Memory of the alarm 2: 0 – off 1 – on
7440	RW	0...5	Alarm type 3: 0 – absolute upper 1 – absolute lower 2 – relative upper 3 – relative lower 4 – relative internal 5 – relative internal
7442	RW	-9999...99999	Alarm 3 set point value
7444	RW	-9999...99999	Alarm 3 deviation (for relative alarms)
7446	RW	0.1...99.9	Alarm 3 hysteresis
7448	RW	0...1	Memory of the alarm 3: 0 – off 1 – on
7450	RW	0...5	Alarm type 4: 0 – absolute upper 1 – absolute lower 2 – relative upper 3 – relative lower 4 – relative internal 5 – relative internal
7452	RW	-9999...99999	Alarm 4 set point value
7454	RW	-9999...99999	Alarm 4 deviation (for relative alarms)
7456	RW	0.1...99.9	Alarm 4 hysteresis
7458	RW	0...1	Memory of the alarm 4: 0 – off 1 – on

7460	RW	0...5	Alarm type 5: 0 – absolute upper 1 – absolute lower 2 – relative upper 3 – relative lower 4 – relative internal 5 – relative internal
7462	RW	-9999...99999	Alarm 5 set point value
7464	RW	-9999...99999	Alarm 5 deviation (for relative alarms)
7466	RW	0.1...99.9	Alarm 5 hysteresis
7468	RW	0...1	Memory of the alarm 5: 0 – off 1 – on
7470	RW	0...5	Alarm type 6: 0 – absolute upper 1 – absolute lower 2 – relative upper 3 – relative lower 4 – relative internal 5 – relative internal
7472	RW	-9999...99999	Alarm 6 set point value
7474	RW	-9999...99999	Alarm 6 deviation (for relative alarms)
7476	RW	0.1...99.9	Alarm 6 hysteresis
7478	RW	0...1	Memory of the alarm 6: 0 – off 1 – on
7480	RW	1...247	Address
7482	RW	0...5	Baud rate 0 – 4800 bps 1 – 9600 bps 2 – 19.2k bps 3 – 38.4k bps 4 – 57.6k bps 5 – 115.2k bps

7484	RW	0...4	Transmission protocol: 0 – none 1 – RTU 8N2 2 – RTU 8E1 3 – RTU 8O1 4 – RTU 8N1
7486	RW	0...10	LCD illumination
7488	RW	0...1	Language 0 – English 1 – Polish
7490	RW	0...1	Shot outputs state 0 – no 1 – yes
7492	RW	0...1	Show binary inputs state 0 – no 1 – yes
7494	RW	0...1	Show clock 0 – no 1 – yes
7496	RW	0.0...100.0 [%]	Minimum control signal in loop 1
7498	RW	0.0...100.0 [%]	Maximum control signal in loop 1
7500	RW	0.0...100.0 [%]	Minimum control signal in loop 2
7502	RW	0.0...100.0 [%]	Maximum control signal in loop 2
7504	RW	-9999...99999	Cascade control set point Lo
7506	RW	-9999...99999	Cascade control set point Hi
7508	RW	1..86400 [s]	Countdown time of alarm timer 1
7510	RW	1..86400 [s]	Countdown time of alarm timer 2
7512	RW	1..86400 [s]	Countdown time of alarm timer 3
7514	RW	1..86400 [s]	Countdown time of alarm timer 4
7516	RW	1..86400 [s]	Countdown time of alarm timer 5
7518	RW	1..86400 [s]	Countdown time of alarm timer 6
7520	RW	1..86400 [s]	Countdown time of alarm timer 1 latch

7522	RW	1..86400 [s]	Countdown time of alarm timer 2 latch
7524	RW	1..86400 [s]	Countdown time of alarm timer 3 latch
7526	RW	1..86400 [s]	Countdown time of alarm timer 4 latch
7528	RW	1..86400 [s]	Countdown time of alarm timer 5 latch
7530	RW	1..86400 [s]	Countdown time of alarm timer 6 latch
7532	RW	-9999...99999	Set point value for alarm timer 1
7534	RW	-9999...99999	Set point value for alarm timer 2
7536	RW	-9999...99999	Set point value for alarm timer 3
7538	RW	-9999...99999	Set point value for alarm timer 4
7540	RW	-9999...99999	Set point value for alarm timer 5
7542	RW	-9999...99999	Set point value for alarm timer 6

Map of the registers from address 7600

Table 17

Register address	Marking	Operations	Parameter range	Description
7600		RW	0...9	Number of realized program (0 means first program) – loop 1
7602		RW	0...1	Program start/stop – loop 1 0 – program stop 1 – program start (saving causes program to start from the beginning)
7604		RW	0...1	Program set value accrual stop – loop 1 0 – off 1 – on
7606		RW	0...14	Realized segment (0 means first segment) – loop 1 Saving causes a jump to the given segment

7608		R-		Control status – loop 1 0 – control stop (in the first section) 1 – control stop (in the current section) 2 – program running 3 – control deviation block active 4 – set value accrual stop (via button, binary input or interface) 5 – program end
7610		R-		Number of cycles left - loop 1
7612		R-		Section time elapsed [s] - loop 1
7614		R-		Segment time remaining [s] – loop 1
7616		R-		Program time elapsed [s] - loop 1
7618		R-		Program time remaining [s] – loop 1
7620		RW		Reserved
7622		RW		Reserved
7624		RW		Reserved
7626		RW		Reserved
7628		RW		Reserved
7630		RW	10...19	Number of realized program (10 means eleventh program) – loop 2
7632		RW	0...1	Program start/stop – loop 2 0 – program stop 1 – program start (saving causes program to start from the beginning)
7634		RW	0...1	Program set value accrual stop – loop 2 0 – off 1 – on

7636		RW	0...14	Realized segment (0 means first segment) – loop 2 Saving causes a jump to the given segment
7638		R-		Control status – loop 2 0 – control stop (in the first section) 1 – control stop (in the current section) 2 – program running 3 – control deviation block active 4 – set value accrual stop (via button, binary input or interface) 5 – program end
7640		R-		Number of cycles left - loop 2
7642		R-		Section time elapsed [s] - loop 2
7644		R-		Segment time remaining [s] – loop 2
7646		R-		Program time elapsed [s] - loop 2
7648		R-		Program time remaining [s] – loop 2
7650		RW		Reserved
7652		RW		Reserved
7654		RW		Reserved
7656		RW		Reserved
7658		RW		Reserved

Address first register	Last register address	Description
7660	7676	Program 1 parameters
7678	7886	Sections 1 – 15 of program 1
7888	7904	Program 2 parameters
7906	8114	Sections 1 – 15 of program 2
8116	8132	Program 3 parameters
8134	8342	Sections 1 – 15 of program 3
8344	8360	Program 4 parameters
8362	8570	Sections 1 – 15 of program 4
8572	8588	Program 5 parameters
8590	8798	Sections 1 – 15 of program 5
8800	8816	Program 6 parameters
8818	9028	Sections 1 – 15 of program 6
9028	9044	Program 7 parameters
9046	9254	Sections 1 – 15 of program 7
9256	9272	Program 8 parameters
9274	9482	Sections 1 – 15 of program 8
9484	9500	Program 9 parameters
9502	9710	Sections 1 – 15 of program 9
9712	9728	Program 10 parameters
9730	9938	Sections 1 – 15 of program 10
9940	9956	Program 11 parameters

9958	10166	Sections 1 – 15 of program 11
10168	10184	Program 12 parameters
10186	10394	Sections 1 – 15 of program 12
10396	10412	Program 13 parameters
10414	10622	Sections 1 – 15 of program 13
10624	10640	Program 14 parameters
10642	10850	Sections 1 – 15 of program 14
10852	10868	Program 15 parameters
10870	11078	Sections 1 – 15 of program 15
11080	11096	Program 16 parameters
11098	11306	Sections 1 – 15 of program 16
11308	11324	Program 17 parameters
11326	11534	Sections 1 – 15 of program 17
11536	11552	Program 18 parameters
11554	11762	Sections 1 – 15 of program 18
11764	11780	Program 19 parameters
11782	11990	Sections 1 – 15 of program 19
11992	11008	Program 20 parameters
12010	11218	Sections 1 – 15 of program 20

Register address		Marking	Operations	Parameter range	Description
+ 0	Program parameters	PrgStart	RW	0...1	Program start method 0 – from the value defined by SP0 1 – from the current measured value
+ 2		Start SP	RW	MIN..MAX 1)	Initial set point value
+ 4		Time Unit	RW	0...1	Unit of the segment duration time 0 – minutes and seconds 1 – hours and minutes
+ 6		Ramp Unit	RW	0...1	Unit of the set value Ramp rate 0 – minutes 1 – hours
+ 8		Holdback Type	RW	0...3	Control deviation block 0 – inactive 1 – lower 2 – upper 3 – double-sided
+ 10		Cycles Number	RW	1...999	Program iteration no.

+ 12		Power Fail	RW	0...1	Control after supply decay 0 – program continuation 1 – control stop
+ 14		End Type	RW	0...1	Program end control 0 – control stop 1 – fixed set-point control with set value from last segment
+ 16		Gain Sched.	RW	0...1	„Gain Scheduling” function for program 0 – off 1 – on
+ 0	Segment 1	Seg.Type	RW	0...3	Segment type 0 – time-defined segment 1 – accrual-defined segment 2 – set value hold 3 – program end
+ 2		Target SP	RW	MIN..MAX 1)	Set value at the end of a segment
+ 4		Seg. Duration	RW	1...5999	Segment duration time
+ 6		Ramp Rate	RW	1...5500 1)	Set value Ramp rate
+ 8		Holdback Val	RW	0...2000 1)	Upper control deviation value; when it is exceeded, set value accrual is stopped

+ 10		Events	RW	0...7	Events state (bit sum) bit 0 set – event 1 bit 1 set – event 2 bit 2 set – event 3 bit 3 set – event 4 bit 4 set – event 5 bit 5 set – event 6
+ 12		PID	RW	0...3	PID set for a segment 0 – PID1 1 – PID2 2 – PID3 3 – PID4
+ 14	Segment 2	Seg.Type	as per segment 1		
+ 16		Target SP			
+ 18		Segment time			
+ 20		Ramp rate			
+ 22		Holdback Val			
+ 24		Events			
+ 26		PID			
+ 28	Segment 3	Seg.Type	as per segment 1		
+ 30		Target SP			
+ 32		Segment time			
+ 34		Ramp rate			
+ 36		Holdback Val			
+ 38		Events			
+ 40		PID			

+ 42	Segment 4	Seg.Type	as per segment 1
+ 44		Target SP	
+ 46		Segment time	
+ 48		Ramp rate	
+ 50		Holdback Val	
+ 52		Events	
+ 54		PID	
+ 56	Segment 5	Seg.Type	as per segment 1
+ 58		Target SP	
+ 60		Segment time	
+ 62		Ramp rate	
+ 64		Holdback Val	
+ 66		Events	
+ 68		PID	

+ 70	Segment 6	Seg.Type	as per segment 1
+ 72		Target SP	
+ 74		Segment time	
+ 76		Ramp rate	
+ 78		Holdback Val	
+ 80		Events	
+ 82		PID	
+ 84	Segment 7	Seg.Type	as per segment 1
+ 86		Target SP	
+ 88		Segment time	
+ 90		Ramp rate	
+ 92		Holdback Val	
+ 94		Events	
+ 96		PID	

+ 98	Segment 8	Seg. Type	as per segment 1
+ 100		Target SP	
+ 102		Segment time	
+ 104		Ramp rate	
+ 106		Holdback Val	
+ 108		Events	
+ 110		PID	
+ 112	Segment 9	Seg. Type	as per segment 1
+ 114		Target SP	
+ 116		Segment time	
+ 118		Ramp rate	
+ 120		Holdback Val	
+ 122		Events	
+ 124		PID	
+ 126	Segment 10	Seg. Type	as per segment 1
+ 128		Target SP	
+ 130		Segment time	
+ 132		Ramp rate	
+ 134		Holdback Val	
+ 136		Events	
+ 138		PID	

+ 140	Segment 11	Seg.Type	as per segment 1
+ 142		Target SP	
+ 144		Segment time	
+ 146		Ramp rate	
+ 148		Holdback Val	
+ 150		Events	
+ 152		PID	
+ 154	Segment 12	Seg.Type	as per segment 1
+ 156		Target SP	
+ 158		Segment time	
+ 160		Ramp rate	
+ 162		Holdback Val	
+ 164		Events	
+ 166		PID	
+168	Segment 13	Seg.Type	as per segment 1
+ 170		Target SP	
+ 172		Segment time	
+ 174		Ramp rate	
+ 176		Holdback Val	
+ 178		Events	
+ 180		PID	

+ 182	Segment 14	Seg.Type	as per segment 1
+ 184		Target SP	
+ 186		Segment time	
+ 188		Ramp rate	
+ 190		Holdback Val	
+ 192		Events	
+ 194		PID	
+ 196	Segment 15	Seg.Type	as per segment 1
+ 198		Target SP	
+ 200		Segment time	
+ 202		Ramp rate	
+ 204		Holdback Val	
+ 206		Events	
+ 208		PID	

13. SOFTWARE UPGRADE

Controller software may be upgraded. New software versions are available as a one file on the website: www.sifamtinsley.com.

The correct file name is „RE92.img”. If it is different, please change it to the correct name. After copying this file to the main directory of the SD card, controller software may begin To do this: when controller is off, press and hold left button and then turn a controller supply on.

14. TECHNICAL DATA

Input 1 and 2

Input signals and measuring ranges

Table 18

Sensor type	Standard	Range		Intrinsic error
Pt100	EN 60751:2009	-200...850 °C	-328...1562 °F	0.2%
Pt500		-200...850 °C	-328...1562 °F	0.2%
Pt1000		-200...850 °C	-328...1562 °F	0.2%
Ni100		-60...180 °C	-76...356 °F	0.2%
Ni1000		-60...150 °C	-76...302 °F	0.2%
Cu100		-50...180 °C	-58...356 °F	0.2%
Fe-CuNi (J)	EN 60584- 1:1997	-100...1200 °C	-148...2192 °F	0.3%
Cu-CuNi (T)		-100...400 °C	-148...752 °F	0.3%
NiCr-NiAl (K)		-100...1372 °C	-148...2501.6 °F	0.3%
PtRh10-Pt (S)		0...1767 °C	32...3212.6 °F	0.5%
PtRh13-Pt (R)		0...1767 °C	32...3212.6 °F	0.5%
PtRh30-PtRh6 (B)		0...1767 °C ¹⁾	32...3212.6 °F ¹⁾	0.5%
NiCr-CuNi (E)		-100...1000 °C	-148...1832 °F	0.3%
NiCrSi-NiSi (N)		-100...1300 °C	-148...2372 °F	0.3%
chromel – kopel (L)		GOST R 8.585-2001	-100...800 °C	-148...1472 °F
linear current (I)		0...20 mA	0...20 mA	0.2% ± 1 digit
linear current (I)		4...20 mA	4...20 mA	0.2% ± 1 digit
linear voltage (U)		0...5 V	0...5 V	0.2% ± 1 digit
linear voltage (U)		0...10 V	0...10 V	0.2% ± 1 digit

¹⁾ Intrinsic error is related to the measuring range 200...1767 °C
(392...3212,6 °F)

Additional errors:

- from automatic compensation
reference junction temperature $\leq 2^{\circ}\text{C}$
- from automatic resistance compensation
of resistance thermometer wires $\leq 0.3^{\circ}\text{C}$

**Current flowing through
resistance thermometer sensor** 0.22 mA

Measurement time 0.25 s

Input resistance:

- for voltage input 100 k Ω
- for current input 10 Ω

Error detection in the measurement circuit:

- thermocouple, Pt100, Pt1000 measuring range
exceeded
- 0...10 V over 11 V
- 0...5 V over 5.5 V
- 0...20 mA over 22 mA
- 4...20 mA over 1 mA and over 22 mA

Input 3 (depends on input 3 in ordering code)

Sensor type	Range	Intrinsic error
linear current	0...20 mA	0.2% \pm 1 digit
linear current	4...20 mA	0.2% \pm 1 digit
linear voltage	0...5 V	0.2% \pm 1 digit
linear voltage	0...10 V	0.2% \pm 1 digit
potentiometric 100 Ω	0...100 Ω	0.2% \pm 1 digit
potentiometric 1000 Ω	0...1000 Ω	0.2% \pm 1 digit

Measurement time	0.25 s
Input resistance:	
– for voltage input	100 k Ω
– for current input	50 Ω
Setting range of controller parameters:	
see Table 1	
Binary inputs 1...3	voltageless
– shorting resistance	≤ 10 k Ω
– opening out resistance	≥ 100 k Ω
Output 1 and 2 types:	
– relay voltageless	NOC contact, load capacity 2 A/230 VAC
– voltage transistor	0/5 V, max load capacity 40 mA
Output 3...6 types:	
– relay voltageless	NOC contact, load capacity 2 A/230 VAC
Analog output types 1A and 2A:	
– analog voltage	0...10 V at $R_{load} \geq 1$ k Ω
– analog current	0...20 mA, 4...20 mA at $R_{load} \leq 500$ Ω
Way of output operation:	
– reverse	for heating
– direct	for cooling
Analog outputs error	0.5% of the range
Digital interface	RS-485
– protocol	Modbus

– baud rate	4800, 9600, 19200, 38400, 57600, 115200 bit/s
– mode	RTU – 8N2, 8E1, 8O1, 8N1
– address	1...247
– maximal response time	500 ms

Digital interface	Ethernet
– protocol	Modbus TCP slave

Supply of object transducers	24V d.c. $\pm 5\%$, max.: 30 mA
-------------------------------------	-------------------------------------

Rated operating conditions:

– supply voltage	85...253 V a.c./d.c.
– supply voltage frequency	40...440 Hz
– ambient temperature	0...23...50 °C
– storage temperature	-20...+70 °C
– relative air humidity	< 85 % (no condensation)
– preheating time	30 min
– operating position	any
– resistance of wires connecting the resistance thermometer or thermocouple with controller	< 20 Ω / wire

Power input	< 16 VA
--------------------	---------

Weight	< 0.5 kg
---------------	----------

Protection grade ensured by the housing

acc. to EN 60529

– from the frontal plate	IP65
– from the terminal side	IP20

Additional errors in rated operating conditions caused by:

- ambient temperature change ≤ 100 % intrinsic error value /10 K.

Safety requirements acc. to EN 61010-1

- installation category III,
- pollution level 2,
- maximum phase-to-earth operating voltage:
 - for supply circuit, output 300 V
 - for input circuits 50 V
- altitude a.s.l. < 2000 m

Electromagnetic compatibility:

- noise immunity, acc. to standard EN 61000-6-2
- noise emission, acc. to standard EN 61000-6-4

15. CONTROLLER ORDERING CODE

Versions and ordering

Table 19

	RE92 -	X	X	X	X	X	XX	X	X
Input 3:									
none		0							
current: 0/4...20 mA		1							
voltage: 0...5/10 V		2							
potentiometric transmitter: 100/ 1000 Ω		3							
Output 1 and 2:									
2 relays		1							
2 binary outputs 0/5 V		2							
Analog outputs:									
none						0			
2 analog outputs 0/4...20 mA and 0...10 V					1				
Ethernet:									
none						0			
with Ethernet					1				
Transducer supply:									
none						0			
24 V d.c.						1			
Version:									
standard							00		
custom-made ¹⁾							XX		
Language:									
Polish								P	
English								E	
other ²⁾								X	
Additional quality requirements:									
without additional quality requirements									0
with extra quality inspection certificate									1
acc. to customer's request ²⁾									X

1) - the code will be established by the manufacturer

2) - only after agreeing with a manufacturer

IN STANDARD:

- 2 universal inputs
- 3 binary inputs
- 6 relay outputs
- RS-485 Modbus Slave
- supply 85...253 V a.c./d.c

Example of order:

The code **RE92 -1-1-0-1-0-00-E-0** means:

- RE92 - RE92 controller,
 - 1 - with additional input: current 0/4...20 mA,
 - 1 - output 1 and 2: 2 relays,
 - 0 - analog outputs: none,
 - 1 - with Ethernet,
 - 0 - transducer supply: none,
 - 00 - standard version,
 - E - user's manual in English,
 - 0 - without additional quality requirements.



Sifam Tinsley Instrumentation Inc

3105, Creekside Village Drive, Suite 801

Kennesaw GA 30144

email – psk@sifamtinsley.com

Phone - +1 404 736 4903

RE92-09E